

REVISIONS			
REV	DESCRIPTION, ECN, EAR NO.	DATE	APP'D
C	UPDATED SHIELD WITH NOTCH	OCT 23/20	L.CHAN
D	ADD LED OPTIONS PAGE	JUL26/21	L.CHAN

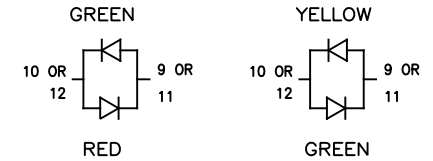

BI-COLOUR LED DETAIL
(RED/YELLOW AND GREEN/ORANGE LED'S ARE ALSO AVAILABLE)

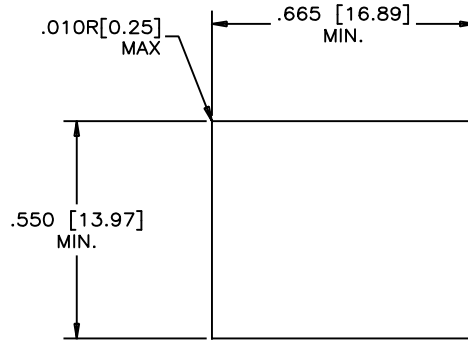
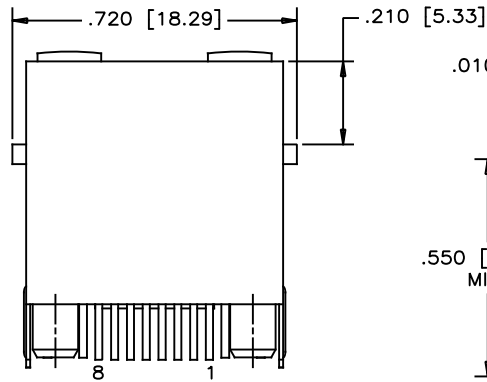

RECOMMENDED PANEL CUTOUT

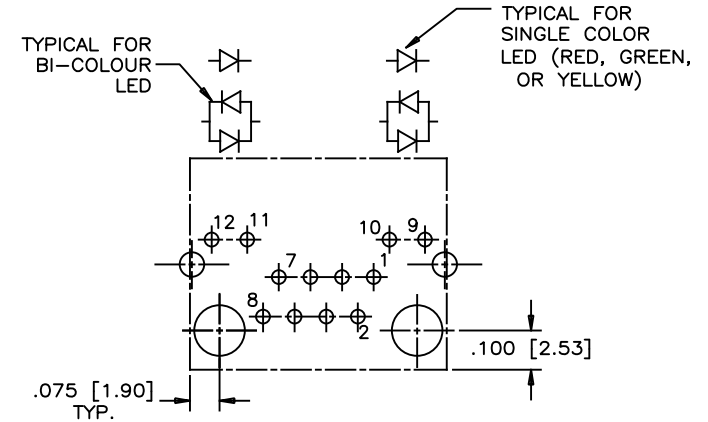

LED SCHEMATIC

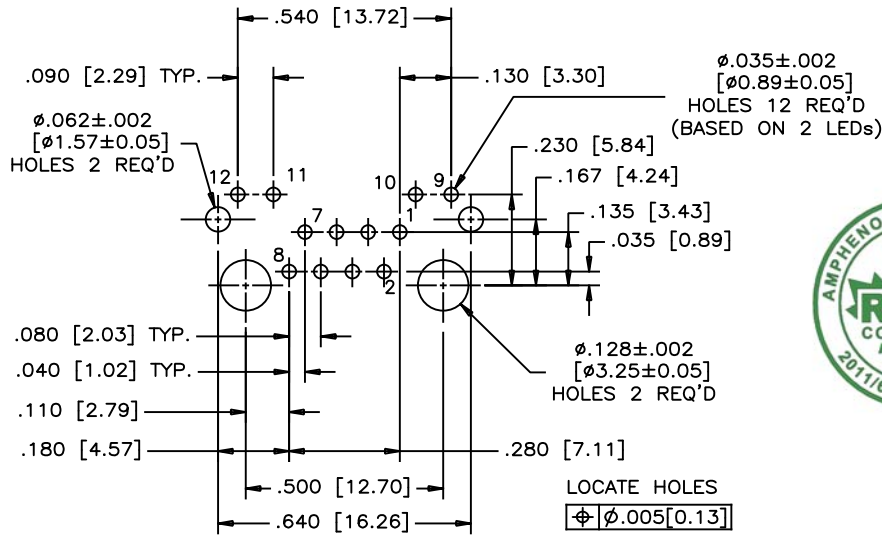

RECOMMENDED P.C.B. LAYOUT
(COMPONENT SIDE OF BOARD)



LOCATE HOLES
 $\varnothing \phi .005 [0.13]$
 POSITION DIMENSIONS ARE BASIC

MATERIALS:

PLASTIC HOUSING: HIGH TEMPERATURE THERMOPLASTIC
 FLAMMABILITY RATING UL 94V-0

CONTACTS: PHOSPHOR BRONZE
 (FLAT) PLATING: 30 μ" [0.76 MICRONS]
 MIN. GOLD ON MATING SURFACES.
 50 μ" [1.27 MICRONS]
 MIN. NICKEL UNDERPLATE
 100 μ" [2.54 MICRONS]
 MIN. MATTE TIN ON CONTACT TAILS.

SHIELD: STAINLESS STEEL WITH TIN DIPPED ON SOLDER TAILS

RECOMMENDED SOLDERING TEMPERATURE:
 WAVE SOLDERING TEMPERATURE AT 260°C MAXIMUM
 FOR 5 SEC MAXIMUM.

AMPHENOL PART NUMBER: RJHSE-338X-A1

REFER TO LED OPTIONS DRAWING FOR ORDERING CODES

UNLESS SPECIFIED OTHERWISE	DRAWN <i>J., OUYANG</i>	DATE <i>04/08</i>
PRIMARY UNITS INCH	CHECKED <i>Lawrence C</i>	DATE <i>JUL 04/08</i>
SECONDARY MILLIMETERS	M.E. APP'D	
REFERENCE IN PARENTHESES	Q.A. APP'D	
GENERAL TOLERANCES	DWG APPR.	
1 DECIMAL PLACE ±0.025	ENG. REL. NO.	
2 DECIMAL PLACES ±0.020	REF.	
3 DECIMAL PLACES ±0.015	THIRD ANGLE PROJECTION	DO NOT SCALE DRAWING
ANGULAR DEGREES ±1.0°		

Amphenol Canada Corp. Commercial Products	
TITLE: SINGLE-PORT HIGH SPEED MODULAR JACK, 8 POSITIONS, 8 FLAT CONTACTS, WITH LED'S AND SHIELD .130" CONTACTS TAIL LENGTH - RoHS COMPLIANT	
DWG. NO.	P-RJHSE-338X-A1
REV	D
CODE ID NO. 03554	DWG SIZE: C SCALE: N/A SHEET 1 OF 2

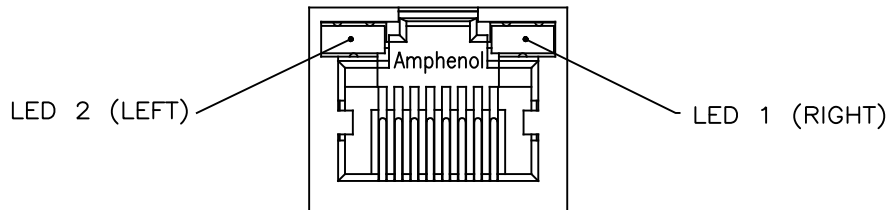

TYPICAL FOR SINGLE & MULTI-PORT

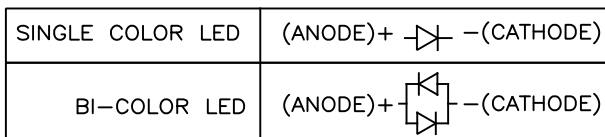

LED COLOR CODE

CODE	LED 2 (LEFT)	LED 1 (RIGHT)	CODE	LED 2 (LEFT)	LED 1 (RIGHT)	CODE	LED 2 (LEFT)	LED 1 (RIGHT)
0	BLOCKED	BLOCKED	9	GREEN	BLOCKED	J	BiC RD/GR	YELLOW
1	YELLOW	GREEN	A	BiC GR/YE	BiC GR/YE	K	YELLOW	BiC GR/OR
2	BLOCKED	GREEN	B	BiC RD/GR	BiC RD/GR	L	BiC GR/YE	RED
3	YELLOW	BLOCKED	C	BiC RD/GR	BiC GR/YE	M	RED	YELLOW
4	GREEN	YELLOW	D	GREEN	BiC GR/YE	N	BiC GR/RD	BiC GR/YE
5	GREEN	GREEN	E	YELLOW	BiC GR/YE	P	GREEN	BiC RD/GR
6	YELLOW	YELLOW	F	BiC GR/YE	YELLOW	R	BiC GR/OR	GREEN
7	RED	GREEN	G	BiC GR/OR	BiC GR/OR	T	RED	RED
8	GREEN	RED	H	BiC GR/YE	GREEN	V	BiC RD/GR	GREEN
			W	ADDITIONAL	OPTIONS			

EXAMPLE OF ADDITIONAL LED OPTIONS:

PART NUMBER RJHSE-338W-A1Y

↑ ADDITIONAL LED COLOR CODE
↑ DENOTES ADDITIONAL LED OPTIONS TO BE USED

CODE	LED 2 (LEFT)	LED 1 (RIGHT)	CODE	LED 2 (LEFT)	LED 1 (RIGHT)	CODE	LED 2 (LEFT)	LED 1 (RIGHT)
0	DO NOT USE		F	GREEN	BiC GR/OR	Y	YELLOW	BiC YE/GR
1	RED	BLOCKED	G	GREEN	ORANGE			
2	BiC GR/OR	YELLOW	H	BiC OR/GR	BiC OR/GR	B	LOWC YE	LOWC GR
3	YELLOW	RED	J	BiC YE/GR	BiC YE/GR	C	LOWC GR	LOWC YE
4	BLOCKED	RED	K	BLOCKED	WHITE	D	LOWC GR	LOWC GR
5	BLOCKED	YELLOW	L	GREEN	BiC YE/GR			
6	RED	BiC RD/GR	N	BLUE	RED			
7	BLOCKED	BiC RD/GR	P	BLOCKED	BiC GR/YE			
8	BiC RD/GR	BLOCKED	R	BiC GR/RD	BiC GR/RD			
9	BiC GR/YE	BLOCKED	T	BLOCKED	BiC YE/GR			
A	BiC OR/GR	GREEN	U	ORANGE	BiC GR/YE			
E	BiC GR/YE	BiC GR/RD	V	BLOCKED	BiC GR/RD			

REVISIONS			
REV	DESCRIPTION, ECN, EAR NO.	DATE	APP'D
C	UPDATED SHIELD WITH NOTCH	OCT 23/20	L.CHAN
D	ADD LED OPTIONS PAGE	JUL26/21	L.CHAN

LED SPECIFICATIONS:

FORWARD VOLTAGE: 2.1 VOLTS TYP.
 FORWARD VOLTAGE: 2.9 VOLTS FOR WHITE
 FORWARD VOLTAGE: 3.1 VOLTS FOR BLUE
 REVERSE VOLTAGE: 5.0 VOLTS MIN.
 LUMINOUS INTENSITY:
 18.6 mcd MIN. (AT If=20mA) TYP.
 480 mcd MIN. (AT If=5mA) FOR WHITE
 110 mcd MIN. (AT If=20mA) FOR BLUE

OPERATING TEMPERATURE: -55° TO 85° C
 LEAD SOLDERING TEMPERATURE: 260° C
 (5 SEC, 1/16" FROM CASE)
 PLATING ON TAILS: TIN OR TIN/COPPER
 ALLOY OVER SILVER

PRIMARY COLOR FOR BI-COLOR
 LEDS IN STANDARD ANODE/
 CATHODE CONFIGURATION IS:
 RED-GREEN= RED
 RED-YELLOW= RED
 GREEN-YELLOW= GREEN
 GREEN-ORANGE= GREEN

LEGEND

BiC=BI-COLOR LED
 LOWC=LOW CURRENT LED
 YE=YELLOW
 GR=GREEN
 RD=RED
 OR=ORANGE

NOTE:

THE TWO DIGITS PRECEDING THE
 ADDITIONAL LED CODE MUST BE
 USED IN THE PART NUMBER, WHEN
 ORDERING ANY OF THE ADDITIONAL
 LED OPTIONS.

UNLESS SPECIFIED OTHERWISE		DRAWN <i>J. OUYANG</i> DATE <i>JUL 04/06</i>	Amphenol Canada Corp. Commercial Products
PRIMARY UNITS INCH	CHECKED <i>Lawrence C</i> DATE <i>JUL 04/06</i>	TITLE SINGLE-PORT HIGH SPEED MODULAR JACK, 8 POSITIONS, 8 FLAT CONTACTS, WITH LED'S AND SHIELD .130" CONTACTS TAIL LENGTH - RoHS COMPLIANT	
SECONDARY MILLIMETERS	M.E. APP'D	ENG. REL. NO.	DWG. NO. P-RJHSE-338X-A1
REFERENCE IN PARENTHESES	Q.A. APP'D	REF.	CODE ID NO. 03554 DWG SIZE: C SCALE: N/A SHEET 2 OF 2
GENERAL TOLERANCES	DWG APPR.	THIRD ANGLE PROJECTION	
1 DECIMAL PLACE ±0.025		DO NOT SCALE DRAWING	
2 DECIMAL PLACES ±0.020			
3 DECIMAL PLACES ±0.015			
ANGULAR DEGREES ±1.0°			