

Input voltage ranges up to 121 V DC
 1 or 2 outputs up to 48 V DC
 Up to 2000 V DC I/O electric strength test

- Extremely wide input voltage ranges
- Rated to Basic Isolation
- Electrical isolation, single and dual outputs
- Immunity to IEC/EN 61000-4-2, -3, -4, -5 and -6
- High efficiency (typ. 82%)
- Flex power: flexible load distribution
- No load and short-circuit proof
- High reliability and no derating
- Operating ambient temperature -40...+85 °C
- Industrial and alternative pinout
- DIL 24 case with 8.5 mm profile

Safety according to IEC/EN 60950, UL 1950



¹ For 70 IMX 4 types

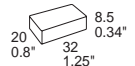

Summary

The IMX 4 series of board mountable 4 Watt DC-DC converters has been designed according to the latest industry requirements and standards. The converters are particularly suitable for use in mobile or stationary applications in transport, industry or telecommunications where variable input voltages or high transient voltages are prevalent.

Covering a total input voltage range from 8.4 V DC up to 121 V DC with three different types the units are available with single and dual outputs from 3.3 up to ±24 V DC with flexible load distribution on dual outputs. Features include efficient input and output filtering with unsurpassed transient and surge protection, low output ripple and noise, consistently high efficiency over the entire input voltage range, high reliability as well as excellent dynamic response to load and line changes.

The converters exhibit basic insulation and are designed and built according to the international safety standards IEC/EN 60950, UL 1950, CAN/CSA C22.2 No.950-95 and are LGA and UL marked. 70 IMX 4 types have are also CE marked.

A special feature is their small case size, DIL 24 with only 8.5 mm profile. The circuit comprises integrated planar magnetics and all components are automatically assembled and solidly soldered onto a single PCB without any wire connections. Thanks to the rigid mechanical design the units withstand an extremely high level of shock and vibrations. Careful considerations of possible thermal stresses ensure the absence of hot spots providing long life in environments where temperature cycles are a reality. The thermal design allows operation at full load up to an ambient temperature of 85°C in free air without using any potting material.

Various options as e.g. extended temperature range -40...85°C, or K-pinout, an alternative to the standard industrial pinout, provide a high level of application specific engineering and design-in flexibility.

Table of Contents

	Page		Page
Summary	1	Electromagnetic Compatibility (EMC)	8
Type Survey and Key Data	2	Mechanical Data	9
Type Key	2	Immunity to Environmental Conditions	10
Functional Description	3	Safety and Installation Instructions	11
Electrical Input Data	4	Description of Options	12
Electrical Output Data	6		

Type Survey and Key Data
Table 1: Type survey

Output 1		Output 2		Output Power	Input voltage range	Efficiency	Type designation	Options ²
$U_{o1\ nom}$ [V DC]	$I_{o1\ nom}$ [A] ¹	$U_{o2\ nom}$ [V DC]	$I_{o2\ nom}$ [A] ¹	$P_{o\ nom}$ [W]	[V DC]	η_{typ} [%]		
3.3	900	-	-	3.0	8.4...36	79	20 IMX 4-03-9	-8, Z
3.3	900	-	-	3.0	16.8...75	80	40 IMX 4-03-9	-8, Z
5	700	-	-	3.5	8.4...36	81	20 IMX 4-05-9	-8, K, Z
5	700	-	-	3.5	16.8...75	81	40 IMX 4-05-9	-8, K, Z
5	700	-	-	3.5	40...121	81	70 IMX 4-05-9	-8
12	340	-	-	4.1	8.4...36	82	20 IMX 4-12-9	-8, K
12	340	-	-	4.1	16.8...75	82	40 IMX 4-12-9	-8, K
12	340	-	-	4.1	40...121	82	70 IMX 4-12-9	-8
15	280	-	-	4.2	8.4...36	82	20 IMX 4-15-9	-8, K
15	280	-	-	4.2	16.8...75	82	40 IMX 4-15-9	-8, K
15	280	-	-	4.2	40...121	82	70 IMX 4-15-8	
+5	350	-5	350	3.5	8.4...36	81	20 IMX 4-0505-9	-8, K, Z
+5	350	-5	350	3.5	16.8...75	81	40 IMX 4-0505-9	-8, K, Z
+5	350	-5	350	3.5	40...121	81	70 IMX 4-0505-8	
+12	170	-12	170	4.1	8.4...36	82	20 IMX 4-1212-9	-8, K, Z
+12	170	-12	170	4.1	16.8...75	82	40 IMX 4-1212-9	-8, Z
+15	140	-15	140	4.2	8.4...36	82	20 IMX 4-1515-9	-8, K, Z
+15	140	-15	140	4.2	16.8...75	82	40 IMX 4-1515-9	-8, K, Z
+24	80	-24	80	3.8	8.4...36	83	20 IMX 4-2424-9	-8, Z
+24	80	-24	80	3.8	16.8...75	83	40 IMX 4-2424-9	-8, Z

¹ Flexible load distribution on double outputs possible.

² Not all options/combinations exist, to check if option exists and/or for minimum order quantity and lead time contact Power-One.

Type Key

 Input voltage range U_i

 8.4...36 V DC 20
 16.8...75 V DC 40
 40...121 V DC 70

Series IMX 4

Output voltage type for output 1 03, 05, 12, 15, 24

Output voltage type for output 2 05, 12, 15, 24

 Operating ambient temperature range T_A

 -40...71°C -9
 -40...85°C -8

 Options: Alternative pinout K
 Open frame Z

20 IMX 4 - 05 05 -9 K Z

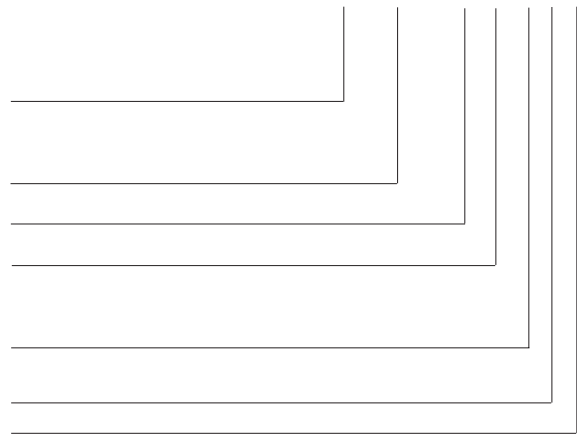
 Example: 40 IMX 4-0505-8K: DC-DC converter, input voltage range 16.8...75 V, 2 outputs providing ± 5 V, 350 mA, temperature range -40...85°C, alternative pinout.

Functional Description

The IMX 4 DC-DC modules are feedback controlled flyback converters using current mode PWM (Pulse Width Modulation).

The converter input is protected against transients by means of a suppressor diode.

The output voltage is monitored by a separate transformer winding close to the secondary windings and fed back to the control circuit.

Current limitation is provided by the primary circuit, thus limiting the total output current ($I_{o\ nom}$ for the single and $I_{o1\ nom} + I_{o2\ nom}$ for the dual output types).

The close magnetic coupling provided by the planar construction ensures very good regulation and allows for flexible load distribution on dual output types.

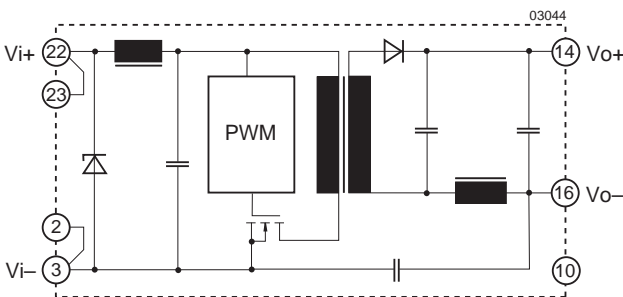

Fig. 1
Block diagram for single output types.
Standard industrial pinout.

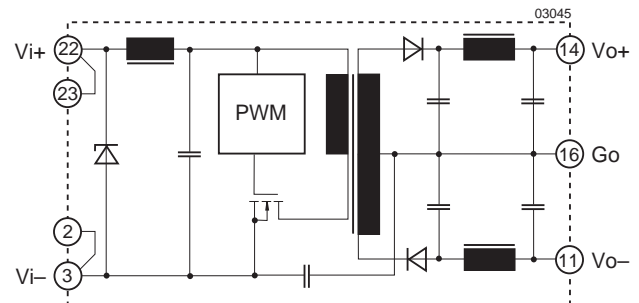

Fig. 2
Block diagram for dual output types.
Standard industrial pinout.

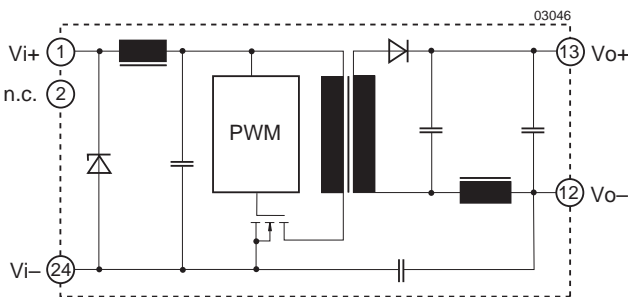

Fig. 3
Block diagram for single output types.
Special pinout (option K).

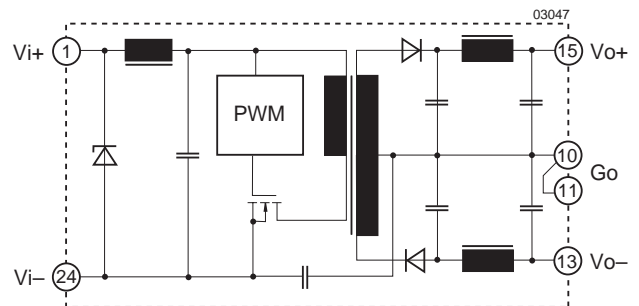

Fig. 4
Block diagram for dual output types.
Special pinout (option K).

Electrical Input Data

 General conditions: $T_A = 25^\circ\text{C}$, unless T_C is specified.

Table 2: Input Data

Input			20 IMX 4			40 IMX 4			70 IMX 4			Unit
Characteristics		Conditions	min	typ	max	min	typ	max	min	typ	max	
U_i	Input voltage range	$T_C \text{ min} \dots T_C \text{ max}$	8.4		36	16.8 ⁴		75	40		121	V DC
$U_{i \text{ nom}}$	Nominal input voltage	$I_o = 0 \dots I_o \text{ nom}$	20			40			70			
$U_{i \text{ sur}}$	Repetitive surge voltage	abs. max input (3 s)	40			100			150			
$t_{\text{start up}}$	Converter start-up time ¹	Worst case condition at $U_{i \text{ min}}$ and full load	0.25		0.5	0.25		0.5	0.25		0.5	s
t_{rise}	Rise time ¹	$U_{i \text{ nom}}$	resistive load			5			5			ms
		$I_o \text{ nom}$	capacitive load			12			12			
$I_{i \text{ o}}$	No load input current	$I_o = 0, U_{i \text{ min}} \dots U_{i \text{ max}}$	15		20	5		10	5		10	mA
C_i	Input capacitance	for surge calculation	0.54			0.3			0.15			μF
$I_{\text{inr p}}$	Inrush peak current	$U_i = U_{i \text{ nom}}^3$	3.7			4.2			5.6			A
f_s	Switching frequency	$U_{i \text{ min}} \dots U_{i \text{ max}}, I_o = 0 \dots I_o \text{ nom}$	approx. 400			approx. 400			approx. 400			kHz
$I_{i \text{ rr}}$	Reflected ripple current	$I_o = 0 \dots I_o \text{ nom}$	100			60			30			mA_{pp}
$U_{i \text{ RFI}}$	Input RFI level conducted and radiated	EN 55022 ²	B ¹			B ¹			A			

¹ Measured with a resistive or max. admissible capacitive load. (See fig.: Converter start-up and rise time)

² External filter required. (See: Filter recommendations for compliance with EN 55022)

³ Source impedance according to prETS 300132-2, version 4.3.

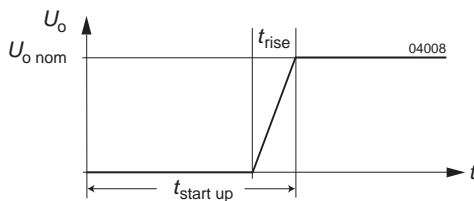
⁴ Operation at lower input voltage possible: P_o approx. 80% of $P_o \text{ nom}$ at $U_{i \text{ min}} = 14.4 \text{ V}$

 Fig. 5
 Converter start-up and rise time

Inrush Current

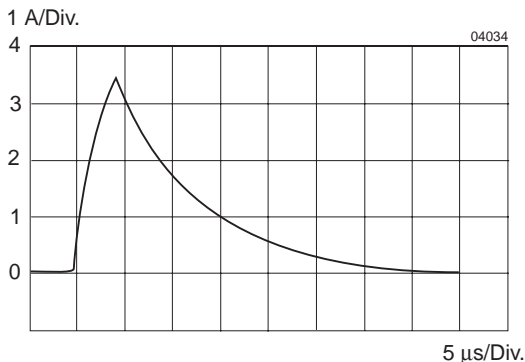
The inrush current has been kept as low as possible by choosing a very small input capacitance. A series resistor may be inserted in the input line to limit this current further.

 Fig. 6
 Typical inrush current at $U_{i \text{ nom}}, P_o \text{ nom}$ versus time (40 IMX 4) measured according to prETS 300132-2, version 4.3.

Reverse Polarity Protection at Input

The suppressor diode on the input also provides for reverse polarity protection by conducting current in the reverse direction, thus protecting the unit. An external fuse is required to limit this current:

- For 20 IMX 4 a fast 1 A (F1A) fuse is recommended
- For 40 IMX 4 a fast 0.63 A (F0.63A) fuse is recommended
- For 70 IMX 4 a fast 0.35 A (F035A) fuse is recommended

Filter recommendations for compliance with EN 55022

 Electromagnetic emission requirements according to table *Input data* can be achieved by adding an external capacitor as close as possible to the input terminals.

 Fig. 7
 Input filter arrangement

Table 3: Input filter components (EN 55022)

Ref.	20 IMX 4	40 IMX 4	70 IMX 4
C_1	4.7 μF , 63 V, 85°C	2.2 μF , 100 V, 85°C	2.2 μF , 150 V, 85°C
Type	ceramic or film		

Input Transient Voltage Protection

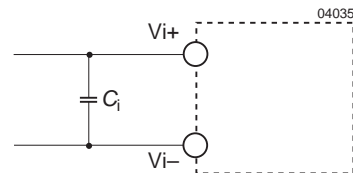
In many applications transient voltages on the input of the converter are always a possibility. These may be caused for example by short circuits between V_{i+} and V_{i-} where the network inductance may cause high energy pulses.

In order to protect the converter a large transient voltage suppressor has been fitted to the input of the IMX 4 types. Specifications as on table below.

Table 4: Built-in transient voltage suppressor

Type	Breakdown Voltage $V_{BR\ nom}$	Peak Power at 1 ms P_P	Peak Pulse Current I_{PP}
20 IMX 4	40 V	600 W	10.3 A
40 IMX 4	100 V	600 W	4.1 A
70 IMX 4	150 V	600 W	2.9 A

If transients generating currents above the peak pulse current I_{PP} are possible then an external limiting network such as the circuit recommended for IEC/EN 61000-4-5 Level 2 compliance is necessary.

To achieve IEC/EN 61000-4-5, level 2 compliance an additional transzorb, inductor and capacitor should be provided externally as shown in the figure below. The components should have similar characteristics as listed in table below.

Table 5: Components for external circuitry (IEC/EN 61000-4-5)

Circuit Ref.	20 IMX 4	40 IMX 4	70 IMX 4
L	330 μ H, 0.42 Ω , 0.6 A TDK TSL1110-331KR55	330 μ H, 0.42 Ω , 0.6 A TDK TSL1110-331KR55	330 μ H, 0.65 Ω , 0.62 A Toko, 494LXF-0098K
C	68 μ F, 63 V, 85°C	68 μ F, 100 V, 85°C	100 μ F, 150 V, 85°C
D	Motorola 1.5KE 39 A	Motorola 1.5KE 82 A	–

To withstand the 150 V transient according to 19 Pfl 1, applicable for 40 IMX 4 types, the same external circuitry with similar components as for IEC/EN 61000-4-5, level 2 compliance can be used.

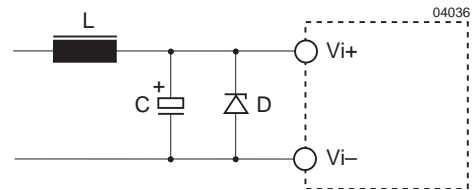

Fig. 8
Example for external circuitry to comply with IEC/EN 61000-4-5, level 2.

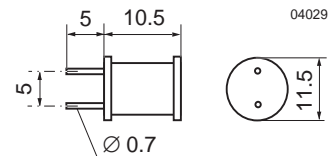

Fig. 9
Dimensions for inductor L

Electrical Output Data

 General conditions: $T_A = 25^\circ\text{C}$, unless T_C is specified.

Table 6a: Output data for single output units

Output		$U_{o\text{ nom}}$	3.3 V			5.0 V			12.0 V			15.0 V			Unit
Characteristics		Conditions	min	typ	max	min	typ	max	min	typ	max	min	typ	max	
U_o	Output voltage	$U_{i\text{ nom}}, I_o = 0.5 I_{o\text{ nom}}$	3.27	3.33		4.96	5.04		11.90	12.10		14.88	15.12	VDC	
$I_{o\text{ nom}}$	Output current	$U_{i\text{ min}} \dots U_{i\text{ max}}$	900			700			340			280			mA
$I_{o\text{ L}}$	Current limit ²	$U_{i\text{ nom}}, T_C = 25^\circ\text{C}$	1800			1400			680			560			
$\Delta U_{o\text{ U}}$	Line regulation	$U_{i\text{ min}} \dots U_{i\text{ max}}, I_{o\text{ nom}}$	± 1			± 1			± 1			± 1			%
ΔU	Load regulation	$U_{i\text{ nom}}$ $I_o = (0.1 \dots 1) I_{o\text{ nom}}$	± 3.5			± 3			± 3			± 3			
$u_{o1,2}$	Output voltage noise	$U_{i\text{ min}} \dots U_{i\text{ max}}$ $I_o = I_{o\text{ nom}}$	80			80			120			150			mV _{pp}
$U_{o\text{ clip}}$	Output overvoltage limitation	Min. load 1%	130			130			130			130			%
$C_{o\text{ ext}}$	Admissible capacitive load ³		<680			<680			<150			<100			μF
$u_{o\text{ d}}$	Dynamic load regulat.	Voltage deviat.	$U_{i\text{ nom}}$			± 250			± 250			± 250			mV
t_{d}		Recovery time	$I_{o\text{ nom}}$ to $1/2 I_{o\text{ nom}}$	1			1			1			1		
α_{U_o}	Temperature coefficient $\Delta U_o / \Delta T_C$	$U_{i\text{ min}} \dots U_{i\text{ max}}$ $I_o = 0 \dots I_{o\text{ nom}}$	± 0.02			± 0.02			± 0.02			± 0.02			%/K

Table 6b: Output data for dual output units

Output		$U_{o\text{ nom}}$	$\pm 5\text{ V}$			$\pm 12\text{ V}^7$			$\pm 15\text{ V}^7$			$\pm 24\text{ V}^7$ ⁸			Unit
Characteristics		Conditions	min	typ	max	min	typ	max	min	typ	max	min	typ	max	
U_{o1} U_{o2}	Output voltage	$U_{i\text{ nom}}$ $I_{o1} = I_{o2} = 0.5 I_{o\text{ nom}}$	4.96	5.04		11.90	12.10		14.88	15.12		23.81	24.19	VDC	
$I_{o\text{ nom}}$	Output current ¹	$U_{i\text{ min}} \dots U_{i\text{ max}}$	2 x 350			2 x 170			2 x 140			2 x 80			mA
$P_{o\text{ L}}$	Power limit ^{2 3}	$U_{i\text{ nom}}, T_C = 25^\circ\text{C}$	2 x 3.5			2 x 4.0			2 x 4.2			2 x 4.0			W
$\Delta U_{o\text{ U}}$	Line regulation	$U_{i\text{ min}} \dots U_{i\text{ max}}, I_{o\text{ nom}}$	± 1			± 1			± 1			± 1			%
ΔU	Load regulation ⁴	$U_{i\text{ nom}}$ $I_o = (0.1 \dots 1) I_{o\text{ nom}}$	± 3			± 3.5			± 3			± 3			
$u_{o1,2}$	Output voltage noise	$U_{i\text{ min}} \dots U_{i\text{ max}}$ $I_o = I_{o\text{ nom}}$	100			140			150			240			mV _{pp}
$U_{o\text{ clip}}$	Output overvoltage limitation	Min. load 1%	130			130			130			130			%
$C_{o\text{ ext}}$	Admissible capacitive load ³		<680			<150			<100			<47			μF
$u_{o\text{ d}}$	Dynamic load regulat.	Voltage deviat.	$U_{i\text{ nom}}$			± 250			± 600			± 750			mV
t_{d}		Recovery time	$I_{o\text{ nom}}$ to $1/2 I_{o\text{ nom}}$	1			1			1			1		
α_{U_o}	Temperature coefficient $\Delta U_o / \Delta T_C$	$U_{i\text{ min}} \dots U_{i\text{ max}}$ $I_o = 0 \dots I_{o\text{ nom}}$	± 0.02			± 0.02			± 0.02			± 0.02			%/K

¹ Each output capable of delivering full output power.

² The current limit is primary side controlled.

³ Sum of both outputs.

⁴ Conditions for specified output. Other output loaded with constant current $I_o = 0.5 I_{o\text{ nom}}$.

⁵ BW = 20 MHz

⁶ Measured with a probe according to EN 61204.

⁷ Not available for 70 IMX 4 types.

Thermal Considerations

If a converter, mounted on a PCB, is located in free, quasi-stationary air (convection cooling) at the indicated maximum ambient temperature $T_{A\max}$ (see table: *Temperature specifications*) and is operated at its nominal input voltage and output power, the case temperature T_C measured at the: *Measuring point of case temperature T_C* (see: *Mechanical Data*) will approach the indicated value $T_{C\max}$ after the warm-up phase. However, the relationship between T_A and T_C depends heavily on the conditions of operation and integration into a system. The thermal conditions are influenced by input voltage, output current, airflow, temperature of surrounding components and surfaces and the properties of the printed circuit board. $T_{A\max}$ is therefore only an indicative value and under practical operating conditions, the ambient temperature T_A may be higher or lower than this value.

Caution: The case temperature T_C measured at the *Measuring point of case temperature T_C* (see: *Mechanical Data*) may under no circumstances exceed the specified maximum value. The installer must ensure that under all operating conditions T_C remains within the limits stated in the table: *Temperature specifications*.

Short Circuit Behaviour

The current limit characteristic shuts down the converter whenever a short circuit is applied to its output. It acts self-protecting and automatically recovers after removal of the overload condition.

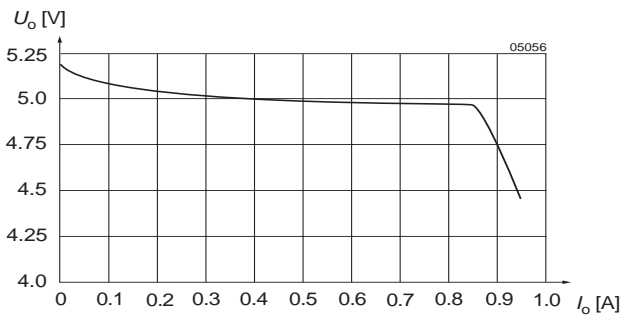

Fig. 10
 U_o versus I_o (typ) of single output units (example for 20/40 IMX 4-05)

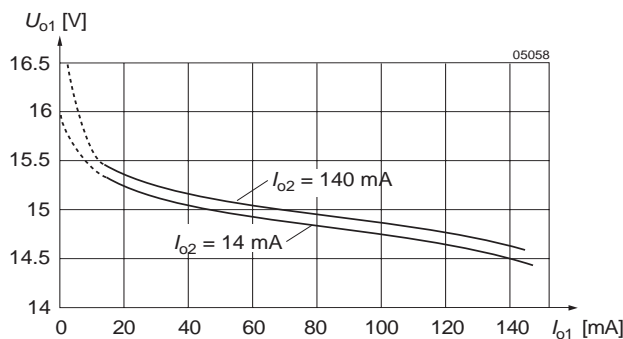

Fig. 12
Cross load regulation of dual output units. U_{o1} versus I_{o1} (typ) for various I_{o2} (40 IMX 4-1515).

Output Overvoltage Protection

The outputs of the IMX 4 converters are protected against overvoltages by Zener diodes. In the event of an overvoltage on the output, the unit will shut-down and attempt to restart automatically. The main purpose of this feature is to protect against possible overvoltages which could occur due to a failure in the feedback control circuit. The units are not designed to withstand external overvoltages applied to the outputs.

Connection in Series

The outputs of single or dual output units can be connected in series without any precautions, taking into consideration that the highest output voltage should remain below 60 V for SELV operation.

Connection in Parallel

Several converters with equal output voltage can be connected in parallel and will share their output current quite equally. However, this may cause start-up problems at initial start-up, and is only recommended in applications where one converter is able to deliver the full load current, e.g. in true redundant systems.

Typical Performance Curves

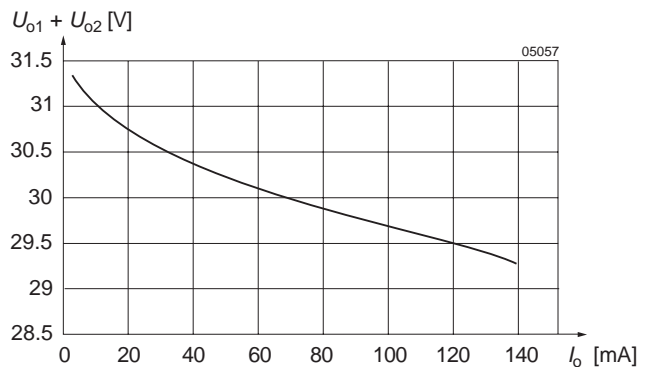

Fig. 11
 U_o versus I_o (typ) of dual output units (± 15 V), with 30 V load connected to Vo+ and Vo-.

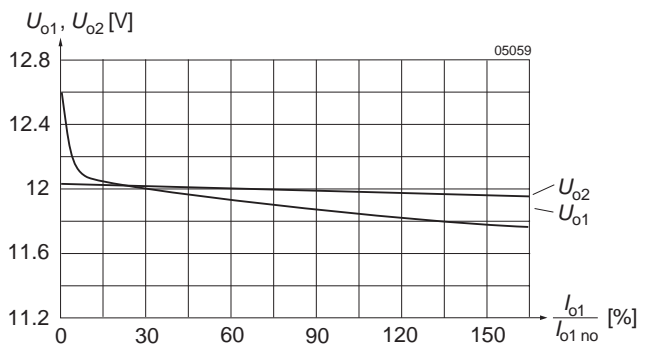

Fig. 13
Flexible load distribution on dual outputs (2×12 V) with load variation from 0...150% of $P_{o1\text{nom}}$ on output 1. Output 2 loaded with 25% of $P_{o2\text{nom}}$.

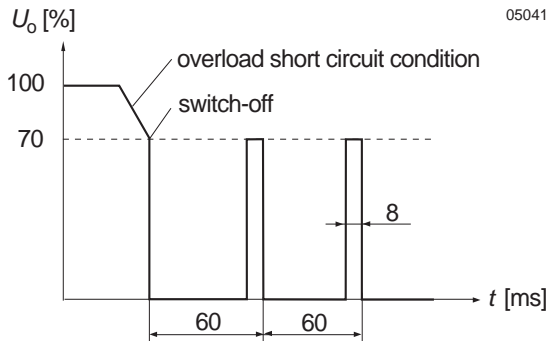

Fig. 14
Overload switch-off (hiccup mode).
Frequency of pulses: 16.5 Hz, puls duration: 8.5 ms.

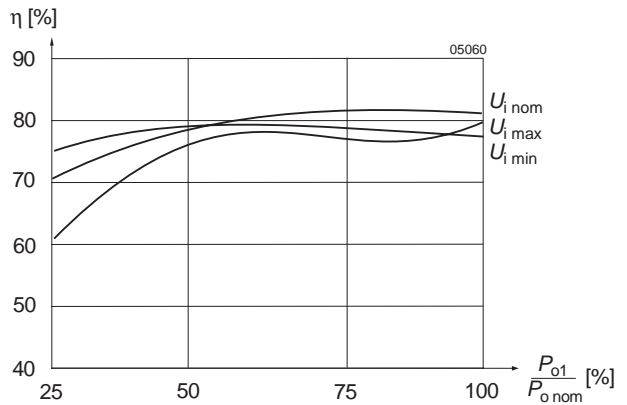

Fig. 15
Efficiency versus input voltage and load.
Typical values (40 IMX 4-1212).

Electromagnetic Compatibility (EMC)

Electromagnetic Immunity

Table 7: Immunity type tests

Phenomenon	Standard ¹	Class Level	Coupling mode ²	Value applied	Waveform	Source Imped.	Test procedure	In oper.	Per-form. ³
Electrostatic discharge to case	IEC/EN 61000-4-2	2	contact discharge	4000 V _p	1/50 ns	330 Ω	10 positive and 10 negative discharges	yes	B
		3	air discharge	8000 V _p					
Electromagnetic field	IEC/EN 61000-4-3	3	antenna	10 V/m	AM 80% 1 kHz		26...1000 MHz	yes	A
	ENV 50204				PM, 50% duty cycle, 200 Hz resp. frequ.		300 MHz		
Electrical fast transient/burst	IEC/EN 61000-4-4	4	+i/-i	4000 V _p	bursts of 5/50 ns 5 kHz rep. rate transients with 15 ms burst duration and a 300 ms period	50 Ω	1 min positive 1 min negative bursts per coupling mode	yes	B
Surge	IEC/EN 61000-4-5 ⁵	2	+i/-i	1000 V _p	1.2/50 μs	2 Ω	5 pos. and 5 neg. surges per coupling mode	yes	A
Conducted disturbances	IEC/EN 61000-4-6	3	+i/-i	3 V _{rms} (140 dBμV)	AM 80% 1 kHz	50 Ω	0.15...80 MHz 150 Ω	yes	A
Transient	19 Pfl 1 ⁴		+i/-i	150 V _p	0.1/0.3 ms	limited to <100 A	3 positive 5 repetitions	yes	A

¹ Related and previous standards are referenced in: *Technical Information: Standards.*

² i = input, o = output

³ A = normal operation, no deviation from specification, B = temporary deviation from specs possible.

⁴ For 40 IMX 4 types (additional external components required). Not applicable for 20 IMX 4 types

⁵ External components required

Electromagnetic Emission

Conducted RFI noise at input according to EN 55022

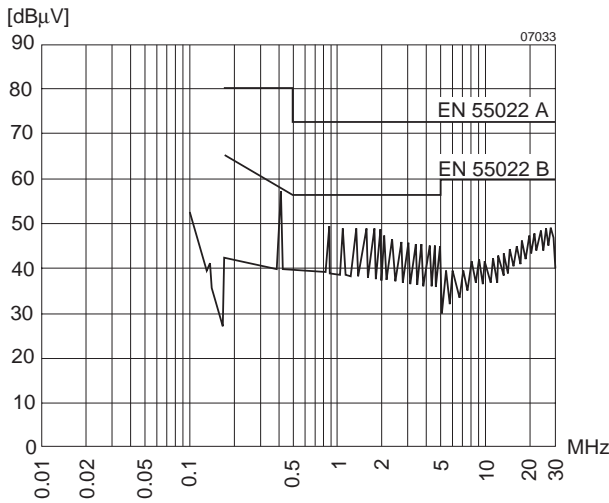

Fig. 16
Typical disturbance voltage (quasi-peak) at the input according to CISPR 11/EN 55011 and CISPR 22/EN 55022, measured at $U_{i\text{ nom}}$ and $I_{o\text{ nom}}$. Output leads 0.1 m, twisted. External capacitor at the input required (see: Recommendations for compliance with EN 55022) (40 IMX 4-1515).

Radiated RFI noise according to EN 55022.

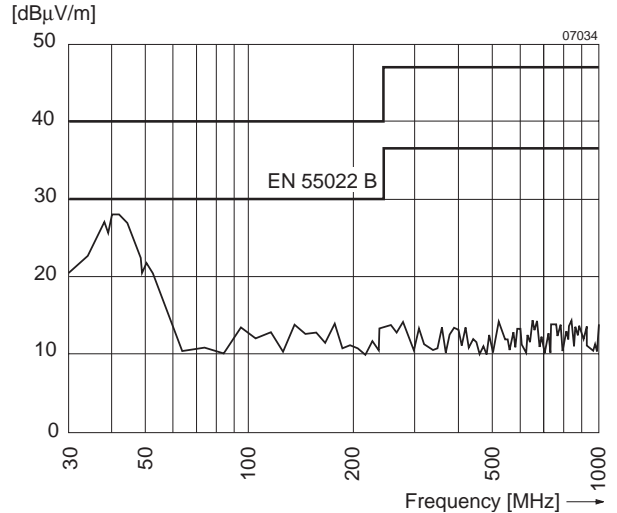

Fig. 17
Typical radio frequency interference voltage at $U_{i\text{ nom}}$, $I_{o\text{ nom}}$, measured with an antenna (distance 10 m). Output leads 0.1 m, twisted (40 IMX 4-1515).

Mechanical Data

Dimensions in mm. Tolerances ± 0.3 mm unless otherwise indicated.

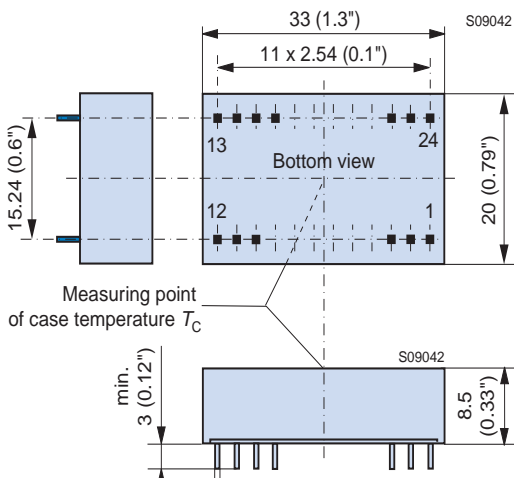

Fig. 18
Standard or alternative pinout (0.5mm pin diameter)
Weight: <10 g

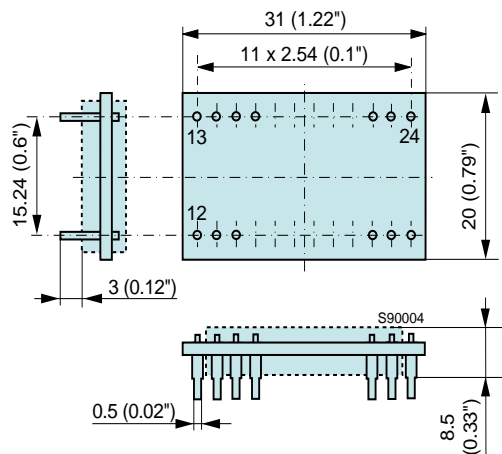

Fig. 19
Open frame (Option Z)
Weight: <10 g

Immunity to Environmental Conditions
Table 8: Environmental testing

Test Method		Standard	Test Conditions		Status
Ca	Damp heat steady state	IEC/DIN IEC 60068-2-3 MIL-STD-810D section 507.2	Temperature: Relative humidity: Duration:	40 ±2 °C 93 +2/-3 % 56 days	Unit not operating
Ea	Shock (half-sinusoidal)	IEC/EN/DIN EN 60068-2-27 MIL-STD-810D section 516.3	Acceleration amplitude: Bump duration: Number of bumps:	100 g _n = 981 m/s ² 6 ms 18 (3 each direction)	Unit operating
Eb	Bump (half-sinusoidal)	IEC/EN/DIN EN 60068-2-29 MIL-STD-810D section 516.3	Acceleration amplitude: Bump duration: Number of bumps:	40 g _n = 392 m/s ² 6 ms 6000 (1000 each direction)	Unit operating
Fc	Vibration (sinusoidal)	IEC/EN/DIN EN 60068-2-6	Acceleration amplitude: Frequency (1 Oct/min): Test duration:	0.35 mm (10...60 Hz) 5 g _n = 49 m/s ² (60...2000 Hz) 10...2000 Hz 7.5 h (2.5 h each axis)	Unit operating
Fh	Vibration, broad-band random (digital control)	IEC/EN 60068-2-64 DIN 40046 part 23 MIL-STD-810D section 514.3	Acceleration spectral density: Frequency band: Acceleration magnitude: Test duration:	0.05 g _n ² /Hz 10...500 Hz 4.9 g _{n rms} 3 h (1 h each axis)	Unit operating
Kb	Salt mist, cyclic (sodium chloride NaCl solution)	IEC/EN/DIN IEC 60068-2-52	Concentration: Duration: Storage: Storage duration: Number of cycles:	5% (30°C) 2 h per cycle 40°C, 93% rel. humidity 22 h per cycle 3	Unit not operating

Table 9: Temperature specifications, valid for air pressure of 800...1200 hPa (800...1200 mbar)

Temperature			Standard -9		Option -8		Unit
Characteristics	Conditions	min	max	min	max		
T _A Ambient temperature ¹	Operational ²	-40	71	-40	85	°C	
T _C Case temperature		-40	95	-40	105		
T _S Storage temperature ¹	Non operational	-40	100	-55	105		

¹ MIL-STD-810D section 501.2 and 502.2

² See *Thermal Considerations*
Table 10: MTBF and device hours (MIL-STD)

MTBF	Ground Benign	Ground Fixed		Ground Mobile
MTBF acc. to MIL-HDBK-217F	T _C = 40°C	T _C = 40°C	T _C = 70°C	T _C = 50°C
40 IMX 4-05-9	2'651'000 h	349'000 h	124'000 h	119'000 h
MTBF acc. to Bellcore	T _C = 40°C	T _C = 40°C	T _C = 70°C	T _C = 50°C
40 IMX 4-1212-9	3'535'000 h	1'768'000 h	917'000 h	476'000 h

Safety and Installation Instructions

Installation Instruction

Installation of the DC-DC converters must strictly follow the national safety regulations in compliance with the enclosure, mounting, creepage, clearance, casualty, markings and segregation requirements of the end-use application.

Connection to the system shall be made via a printed circuit board according to: *Mechanical Data*.

The units should be connected to a secondary circuit.

Check for hazardous voltages before altering any connections.

Do not open the module.

Ensure that a unit failure (e.g. by an internal short-circuit) does not result in a hazardous condition. See also: *Safety of operator accessible output circuit*.

Table 11: Pin allocation for standard industrial pinout and option Z

Pin	Single output units	Dual output units
2	Vi-	Vi-
3	Vi-	Vi-
10	n.c.	-
11	-	Vo-
14	Vo+	Vo+
16	Vo-	Go
22	Vi+	Vi+
23	Vi+	Vi+

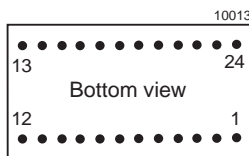

Fig. 20
Pin numbering

Table 12: Pin allocation for option K

Pin	Single output units	Dual output units
1	Vi+	Vi+
2	n.c.	-
10	-	Go
11	-	Go
12	Vo-	-
13	Vo+	Vo-
15	-	Vo+
24	Vi-	Vi-

Input Fuse

To prevent excessive current flowing through the input supply line in case of a short-circuit across the converter input an external fuse should be installed in a non earthed input supply line. We recommend a fast acting fuse F1A for 20 IMX 4, F0.5A for 40 IMX 4 and F0.315A for 70 IMX 4 types.

Safety of Operator Accessible Output Circuits

If the output circuit of a DC-DC converter is operator accessible, it shall be an SELV circuit according to IEC/EN 60950 related safety standards

The insulation concept table on next page shows some possible installation configurations, compliance with which causes the output circuit of the DC-DC converter to be an SELV circuit according to IEC/EN 60950 up to a configured output voltage (sum of nominal voltages if in series or +/- configuration) of 48 V.

However, it is the sole responsibility of the installer to ensure the compliance with the relevant and applicable safety regulations. More information is given in: *Technical Information: Safety*.

Standards and Approvals

All DC-DC converters are UL recognized according to UL 1950, UL recognized for Canada to CAN/CSA C22.2 No. 950-95 and LGA approved to IEC/EN 60950 standards.

The units have been evaluated for:

- Building in
- Basic insulation input to output, based on their maximum input voltage
- The use in a pollution degree 2 environment
- Connecting the input to a secondary circuit which is subject to a maximum transient rating of 1500 V for 20 IMX 4 and 40 IMX 4, 2000 V for 70 IMX 4 types.

The DC-DC converters are subject to manufacturing surveillance in accordance with the above mentioned UL, CSA, EN and ISO 9001 standards.

Cleaning Agents

In order to avoid possible damage, any penetration of cleaning fluids has to be prevented, since the power supplies are not hermetically sealed.

Protection Degree

The protection degree of the DC-DC converters is IP 30.

Isolation

The electric strength test is performed as factory test in accordance with IEC/EN 60950 and UL 1950 and should not be repeated in the field. Power-One will not honour any guarantee claims resulting from electric strength field tests.

Table 14: Electric strength test voltages

Characteristic	Input - Output		Unit
	20/40 IMX 4	70 IMX 4	
Electric strength test voltage 1 s	1.2	1.5	kV _{rms}
	1.5	2.0	kV DC
Coupling capacitance	~1.1	~1.1	nF
Insulation resist. at 500 V DC	>100	>100	MΩ
Partial discharge extinction voltage	Consult factory		kV

Table 15: Insulation concept leading to an SELV output circuit

Conditions	Front end			DC-DC converter	Result
Supply voltage	Minimum required grade of isolation, to be provided by the AC-DC front end, including mains supplied battery charger	Maximum DC output voltage from the front end ¹	Minimum required safety status of the front end output circuit	Measures to achieve the specified safety status of the output circuit	Safety status of the DC-DC converter output circuit
Mains -250 V AC	Basic	<60 V	Earthed SELV circuit ²	Operational insulation, provided by the DC-DC converter	SELV circuit
			ELV circuit	Input fuse ³ output suppressor diodes ⁴ , and earthed output circuit ²	Earthed SELV circuit
	Double or reinforced	<60 V	Hazardous voltage secondary circuit	Operational insulation, provided by the DC-DC converter	SELV circuit
			SELV circuit	Basic insulation, based on the maximum input voltage, provided by the DC-DC converter	
>60 V	TNV-2 circuit	Double or reinforced insulated unearthed hazardous voltage secondary circuit ⁵	Basic insulation, based on the maximum input voltage, provided by the DC-DC converter		

¹ The front end output voltage should match the specified input voltage range of the DC-DC converter.

² The earth connection has to be provided by the installer according to the relevant safety standard, e.g. IEC/EN 60950.

³ The installer shall provide an approved fuse (type with the lowest rating suitable for the application) in a non-earthed input line directly at the input of the DC-DC converter (see fig.: *Schematic safety concept*). For UL's purpose, the fuse needs to be UL-listed. See also: *Input Fuse*.

⁴ Each suppressor diode should be dimensioned in such a way, that in the case of an insulation fault the diode is able to limit the output voltage to SELV (<60 V) until the input fuse blows (see fig.: *Schematic safety concept*).

⁵ Has to be insulated from earth by double or reinforced insulation according to the relevant safety standard, based on the maximum output voltage from the front end.

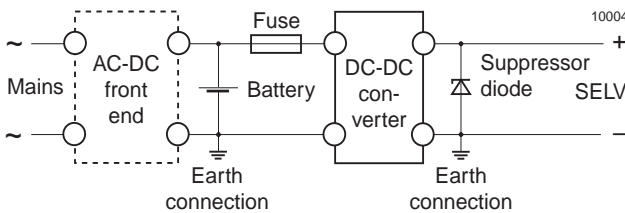

Fig. 21

Schematic safety concept. Use fuse, suppressor diode and earth connection as per table: Safety concept leading to an SELV output circuit.

Description of Options

Table 16: Survey of options

Option	Function of option	Characteristic
-8	Extended operational ambient temperature range	$T_A = -40...85^\circ\text{C}$
K	Alternative pinout	Not available for all types
Z	Open frame	Not available for all types

Option -8

Extension of the temperature range from standard -40...71 °C to -40...85°C. The modules will provide full output power with free air convection cooling.

Option K

Alternative Pinout.

This option defines an alternative pinout, i.e. compatible with IPS 3 series.