

SERIES: V78E-1000-SMT | DESCRIPTION: NON-ISOLATED DC SWITCHING REGULATOR
FEATURES

- 1 A of output current
- efficiency up to 95%
- SMT package
- industrial operating temp -40~+85°C
- designed to meet IEC/EN 62368-1
- industry standard footprint
- no load input current of 0.2 mA
- output short circuit protection on output

**MODEL**

MODEL	input voltage ¹		output voltage (Vdc)	output current max (mA)	output power max (W)	ripple & noise ² max (mVp-p)	efficiency ³ typ (%)
	typ (Vdc)	range (Vdc)					
V78E01-1000-SMT	12	4.75~32	1.5	1000	1.5	75	76
V78E02-1000-SMT	12	4.75~32	2.5	1000	2.5	75	86
V78E03-1000-SMT	24	6.5~36	3.3	1000	3.3	75	90
V78E05-1000-SMT	24	8~36	5	1000	5	75	93
V78E06-1000-SMT	24	10~36	6.5	1000	6.5	75	93
V78E09-1000-SMT	24	13~36	9	1000	9	75	94
V78E12-1000-SMT	24	16~36	12	1000	12	75	95

- Notes:
1. For input voltages higher than 30 Vdc, a 22 μ F / 50 V input capacitor is required.
 2. Tested at nominal input, 20~100% load, 20 Mhz bandwidth, with 10 μ F electrolytic and 1 μ F ceramic capacitor on the output. At loads below 20%, the max ripple and noise will be 150 mVp-p.
 3. Measured at min V_{in} , full load.
 4. All specifications are measured at $T_a=25^\circ\text{C}$, humidity < 75%, nominal input voltage, and rated output load unless otherwise specified.

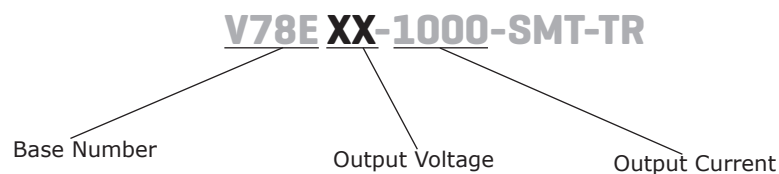
PART NUMBER KEY

INPUT

parameter	conditions/description	min	typ	max	units
operating input voltage ⁵		4.75		36	Vdc
filter	capacitor filter				
input reverse polarity protection	no				
no-load input current			0.2	1.0	mA
remote on/off ⁶	turn on (3.2~5.5 Vdc or open circuit) turn off (<0.8 Vdc) input current when switched off		0.2	1	mA

Note: 5. See Model section on page 1 for specific input voltage ranges.

6. The voltage of remote ON/OFF pin is relative to GND pin.

OUTPUT

parameter	conditions/description	min	typ	max	units
maximum capacitive load ⁷				680	μF
voltage accuracy	at full load, input voltage range 1.5, 2.5, 3.3 Vdc output models all other models		±2 ±2	±4 ±3	% %
line regulation	at full load, input voltage range 1.5, 2.5 Vdc output models all other models		±0.3 ±0.2	±0.6 ±0.4	% %
load regulation	at 10~100 % load, input voltage range 1.5, 2.5 Vdc output models all other models		±0.8 ±0.3	±1.5 ±0.6	% %
voltage adjustment	input voltage range		±10		%Vo
switching frequency	at full load, input voltage range 1.5, 2.5 Vdc output models 3.3, 5, 6.5 Vdc output models all other models		370 520 700		kHz kHz kHz
transient recovery time	at nominal input voltage, 25% load step change		0.2	1	ms
transient response deviation	at nominal input voltage, 25% load step change		50	150	mV
temperature coefficient	operating temperature -40 °C to +85 °C			±0.03	%/°C

Note: 7. The maximum capacitive load was tested at nominal input voltage, full load.

PROTECTIONS

parameter	conditions/description	min	typ	max	units
short circuit protection	continuous, auto recovery				

SAFETY AND COMPLIANCE

parameter	conditions/description	min	typ	max	units
safety approvals	CE				
conducted emissions	CISPR32/EN55032, class B (external circuit required, see Figure 3-b)				
radiated emissions	CISPR32/EN55032, class B (external circuit required, see Figure 3-b)				
ESD	IEC/EN61000-4-2, contact ± 4kV, class B				
radiated immunity	IEC/EN61000-4-3, 10V/m, class A				
EFT/burst	IEC/EN61000-4-4, ± 1kV, class B (external circuit required, see Figure 3-a)				
surge	IEC/EN61000-4-5, line-line ± 1kV, class B (external circuit required, see Figure 3-a)				
conducted immunity	IEC/EN61000-4-6, 3 Vr.m.s, class A				
MTBF	as per MIL-HDBK-217F, 25°C	2,000,000			hours
RoHS	yes				

ENVIRONMENTAL

parameter	conditions/description	min	typ	max	units
operating temperature	see derating curves	-40		85	°C
storage temperature		-55		125	°C
storage humidity	non-condensing	5		95	%

SOLDERABILITY

parameter	conditions/description	min	typ	max	units
reflow soldering	see reflow profile, refer to IPC/JEDEC J-STD-020D.1			245	°C

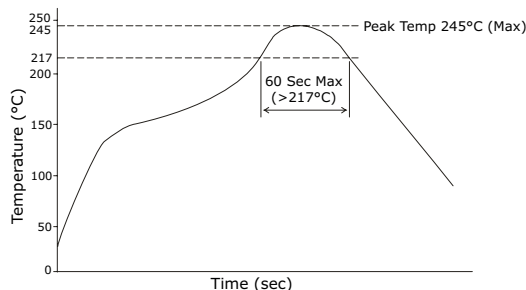

MECHANICAL

parameter	conditions/description	min	typ	max	units
dimensions	15.24 x 8.50 x 8.25 [0.60 x 0.335 x 0.325 inch]				mm
case material	black flame-retardant and heat resistant plastic (UL94V-0)				
weight			1.7		g

MECHANICAL DRAWING

units: mm [inch]
 tolerance: ±0.25[±0.010]
 pin section tolerance: ±0.10[±0.004]

PIN CONNECTIONS	
PIN	FUNCTION
1	+VIN
2	+VIN
3	GND
4	+VOUT
5	+VOUT
6	V adj
7	GND
10	remote on/off

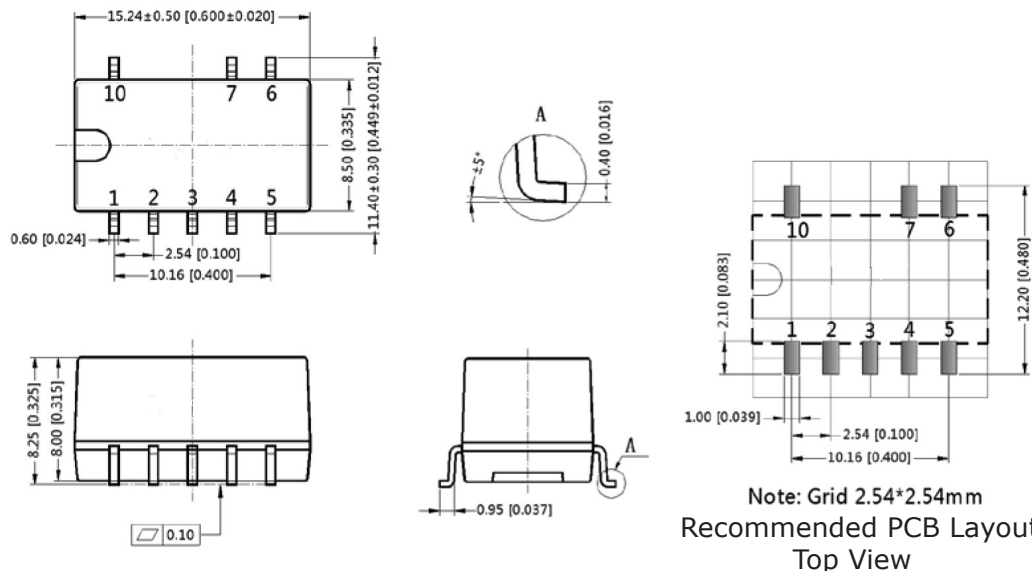

DERATING CURVES

Temperature Derating Curves
9 Vdc Output
(Natural Convection)

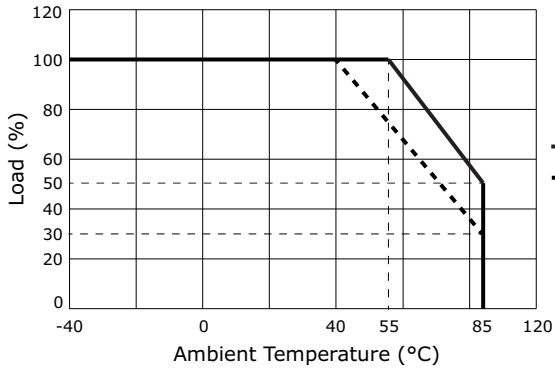

Temperature Derating Curves12
Vdc Output
(Natural Convection)

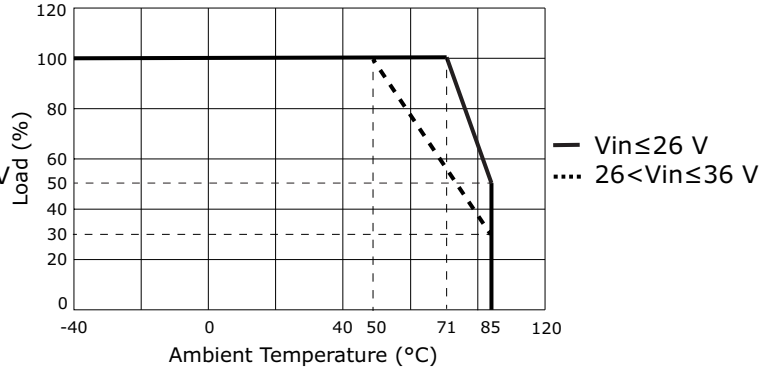

Temperature Derating Curves
All Other Outputs
(Natural Convection)

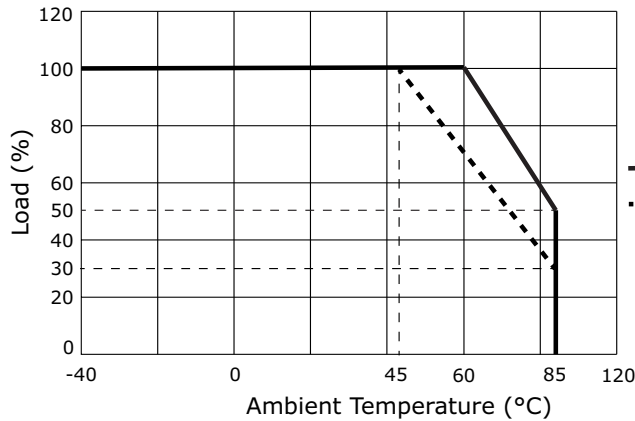

EFFICIENCY CURVES

V78E01-1000-SMT Efficiency Curve
Efficiency vs. Input Voltage
(at full load)

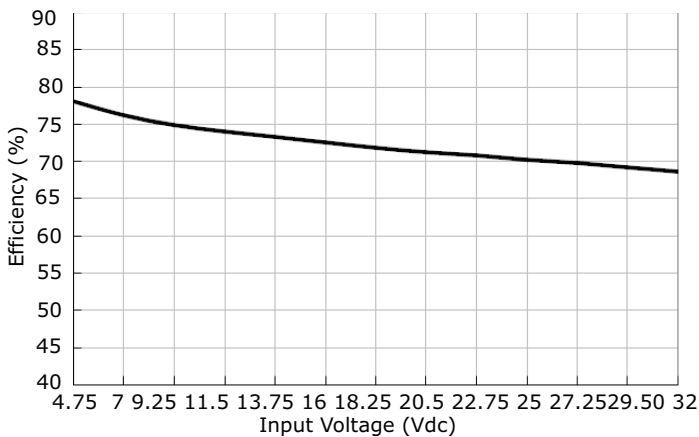

V78E01-1000-SMT Efficiency Curve
Efficiency vs. Load Current
(at V_{in} nominal)

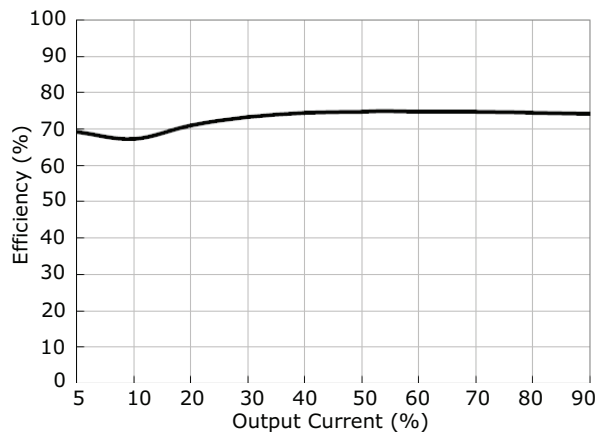

EFFICIENCY CURVES (CONTINUED)

V78E02-1000-SMT Efficiency Curve
Efficiency vs. Input Voltage
(at full load)

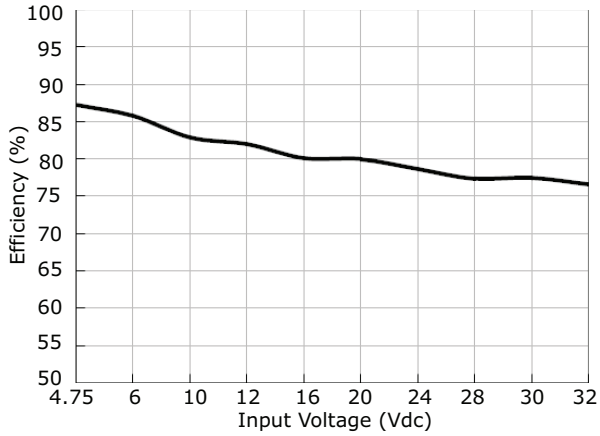

V78E02-1000-SMT Efficiency Curve
Efficiency vs. Load Current
(at Vin nominal)

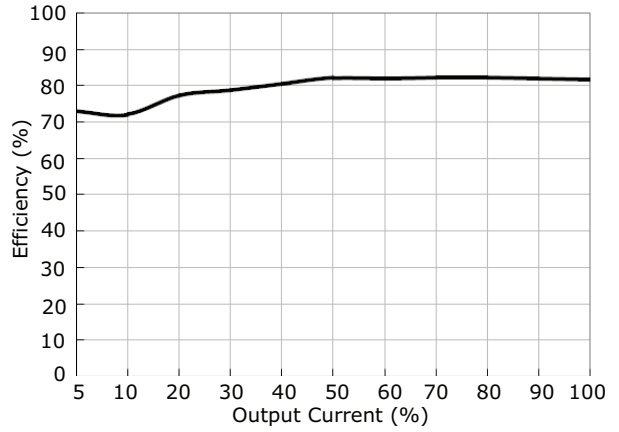

V78E03-1000-SMT Efficiency Curve
Efficiency vs. Input Voltage
(at full load)

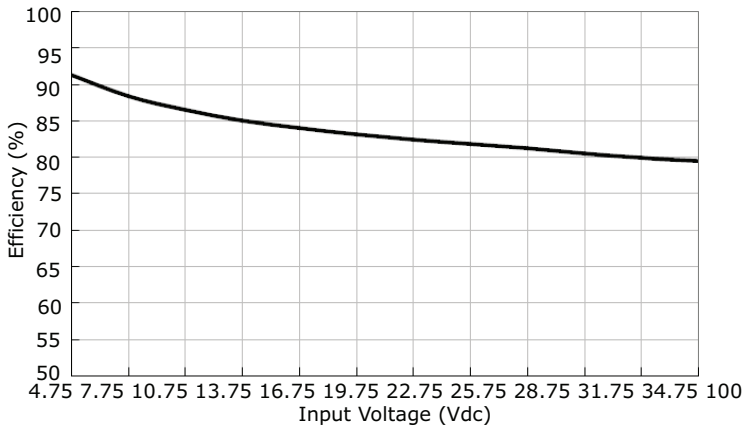

V78E03-1000-SMT Efficiency Curve
Efficiency vs. Load Current
(at Vin nominal)

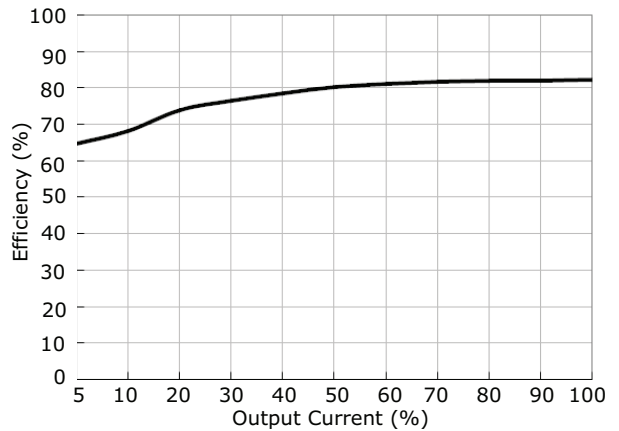

V78E05-1000-SMT Efficiency Curve
Efficiency vs. Input Voltage
(at full load)

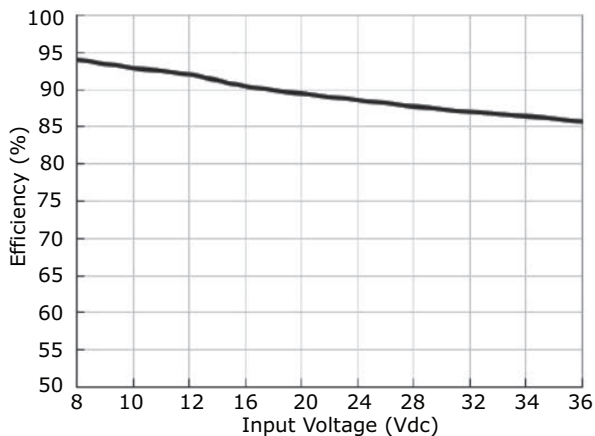

V78E05-1000-SMT Efficiency Curve
Efficiency vs. Load Current
(at Vin nominal)

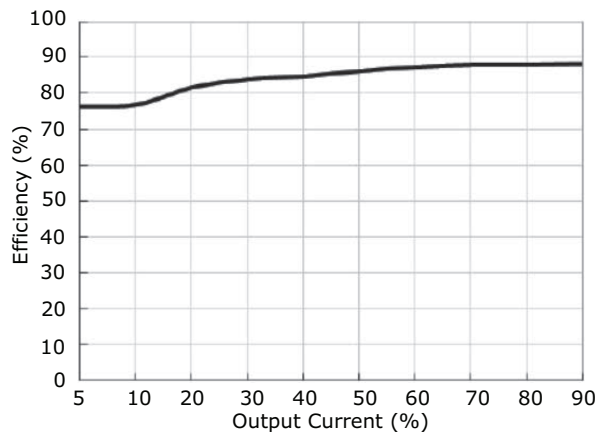

EFFICIENCY CURVES (CONTINUED)

V78E06-1000-SMT Efficiency Curve
Efficiency vs. Input Voltage
(at full load)

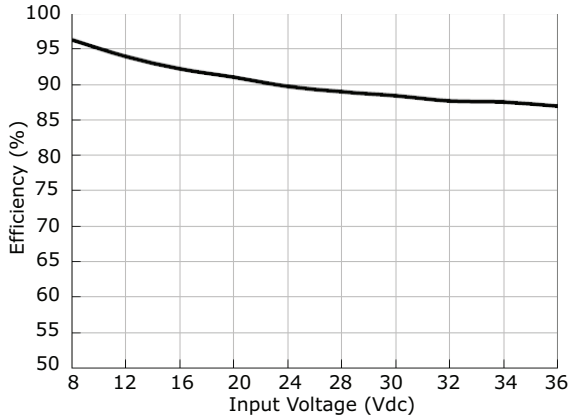

V78E06-1000-SMT Efficiency Curve
Efficiency vs. Load Current
(at Vin nominal)

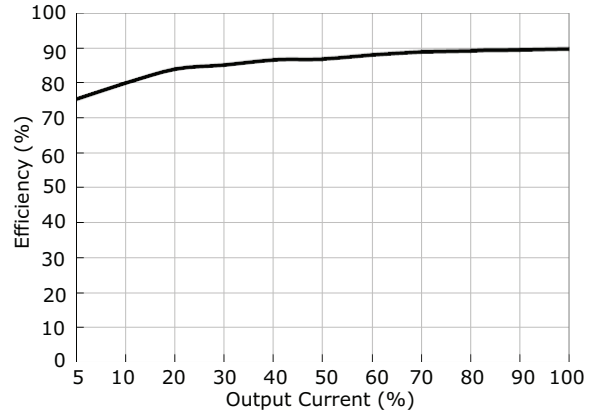

V78E09-1000-SMT Efficiency Curve
Efficiency vs. Input Voltage
(at full load)

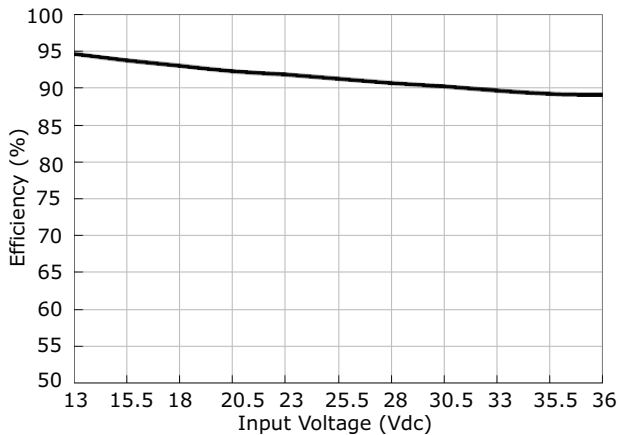

V78E09-1000-SMT Efficiency Curve
Efficiency vs. Load Current
(at Vin nominal)

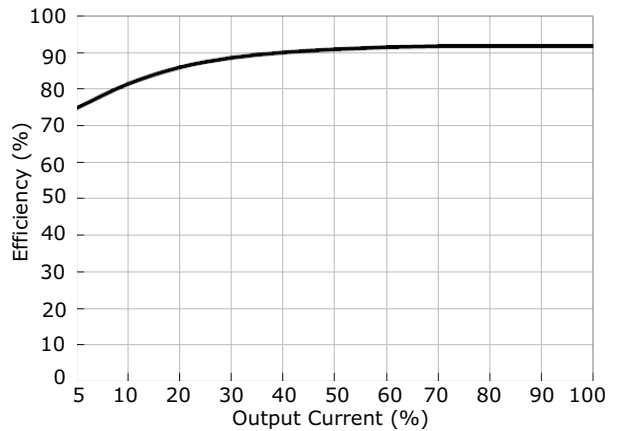

V78E12-1000-SMT Efficiency Curve
Efficiency vs. Input Voltage
(at full load)

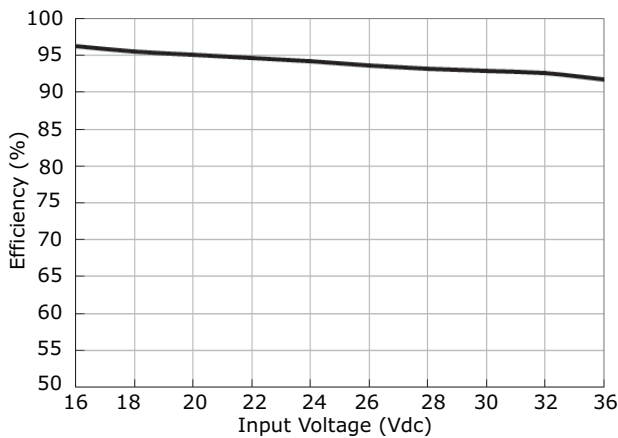

V78E12-1000-SMT Efficiency Curve
Efficiency vs. Load Current
(at Vin nominal)

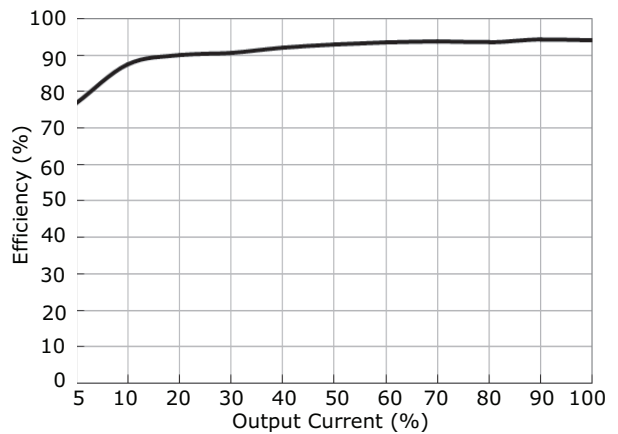

TYPICAL APPLICATION CIRCUIT

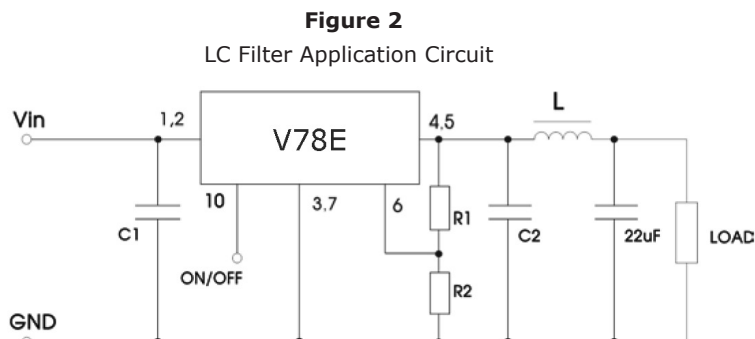
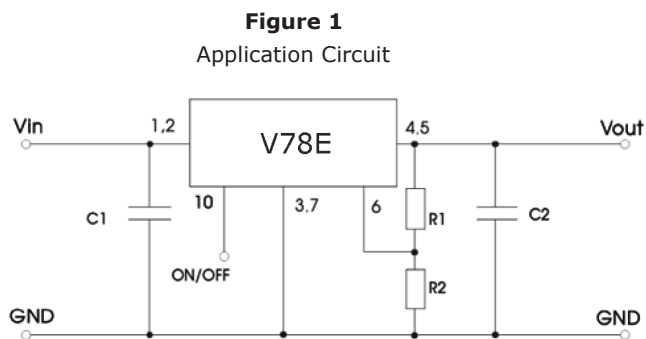

Table 1

Model Number	C1 (ceramic capacitor)	C2 (ceramic capacitor)	Ra1/Ra2 (Vadj resistance)
V78E01-1000-SMT	10 µF/50 V	22 µF/10 V	refer to Vadj resistance calculation
V78E02-1000-SMT	10 µF/50 V	22 µF/10 V	
V78E03-1000-SMT	10 µF/50 V	22 µF/10 V	
V78E05-1000-SMT	10 µF/50 V	22 µF/16 V	
V78E06-1000-SMT	10 µF/50 V	22 µF/16 V	
V78E09-1000-SMT	10 µF/50 V	22 µF/16 V	
V78E12-1000-SMT	10 µF/50 V	22 µF/25 V	

EMC RECOMMENDED CIRCUIT

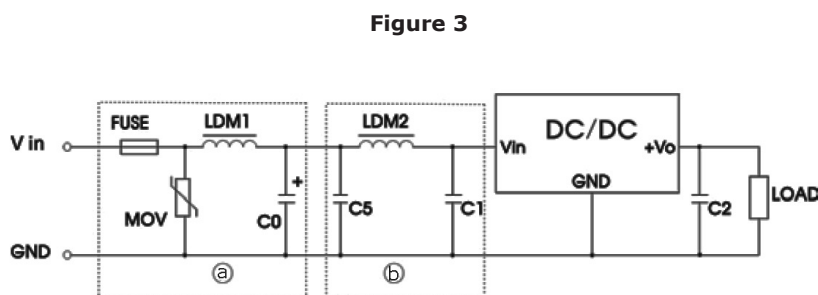

Table 2

Recommended external circuit components	
FUSE	choose according to actual input current
MOV	S20K30
LDM1	82 µH
C0	680 µF/50 V
C1, C2	refer to table 1
C5	4.7 µF/50 V
LDM2	68 µH

Note:
 8. C1 & C2 are required and should be connected as close to the module pins as possible.
 9. C1 & C2 can be increased as needed and the use of tantalum or low ESR electrolytic capacitors would be recommended.
 10. To reduce the output ripple further, it is recommended to add an "LC" filter at the output (see figure 2) with a 10~47 µH L component.

APPLICATION NOTES

- Output voltage trimming**
Leave open if not used.

Figure 4

Application Circuit for Trim pin
(part in broken line is the interior of models)

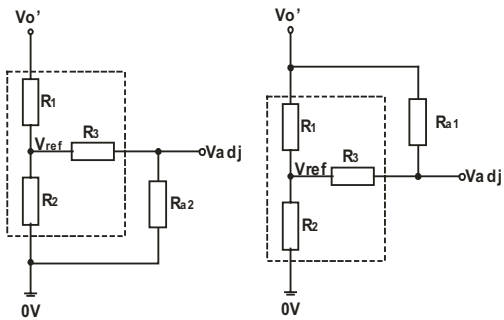

Formula for Trim Resistor

$$\text{up: } R_{a2} = \frac{a R_2}{R_2 - a} - R_3 \quad a = \frac{V_{ref}}{V_{o'} - V_{ref}} \cdot R_1$$

$$\text{down: } R_{a1} = \frac{a R_1}{R_1 - a} - R_3 \quad a = \frac{V_{o'} - V_{ref}}{V_{ref}} \cdot R_2$$

Note: Value for R1, R2, R3, and Vref refer to Table 3
Ra1/Ra2: Trim Resistor
a: User-defined parameter, no actual meanings
Vo': The trim up/down voltage

Table 3

Vout (Vdc)	R1 (kΩ)	R2 (kΩ)	R3 (kΩ)	Vref (V)
1.5 ¹¹	7.5	7.5	15	0.75
2.5	9.1	3.9	8.2	0.75
3.3	75	22	75	0.75
5	43	7.5	33	0.75
6.5	43	5.6	22	0.75
9	43	3.9	22	0.75
12	36	2.4	10	0.75

Note: 11. The 1.5 Vdc output model can only be adjusted up.

PACKAGING

units: mm

Reel Size: Ø330 mm
 Reel QTY: 300 pcs per tray
 Carton Box Size: 400 x 365 x 255 mm
 Carton Box QTY: 1,800 pcs per carton box

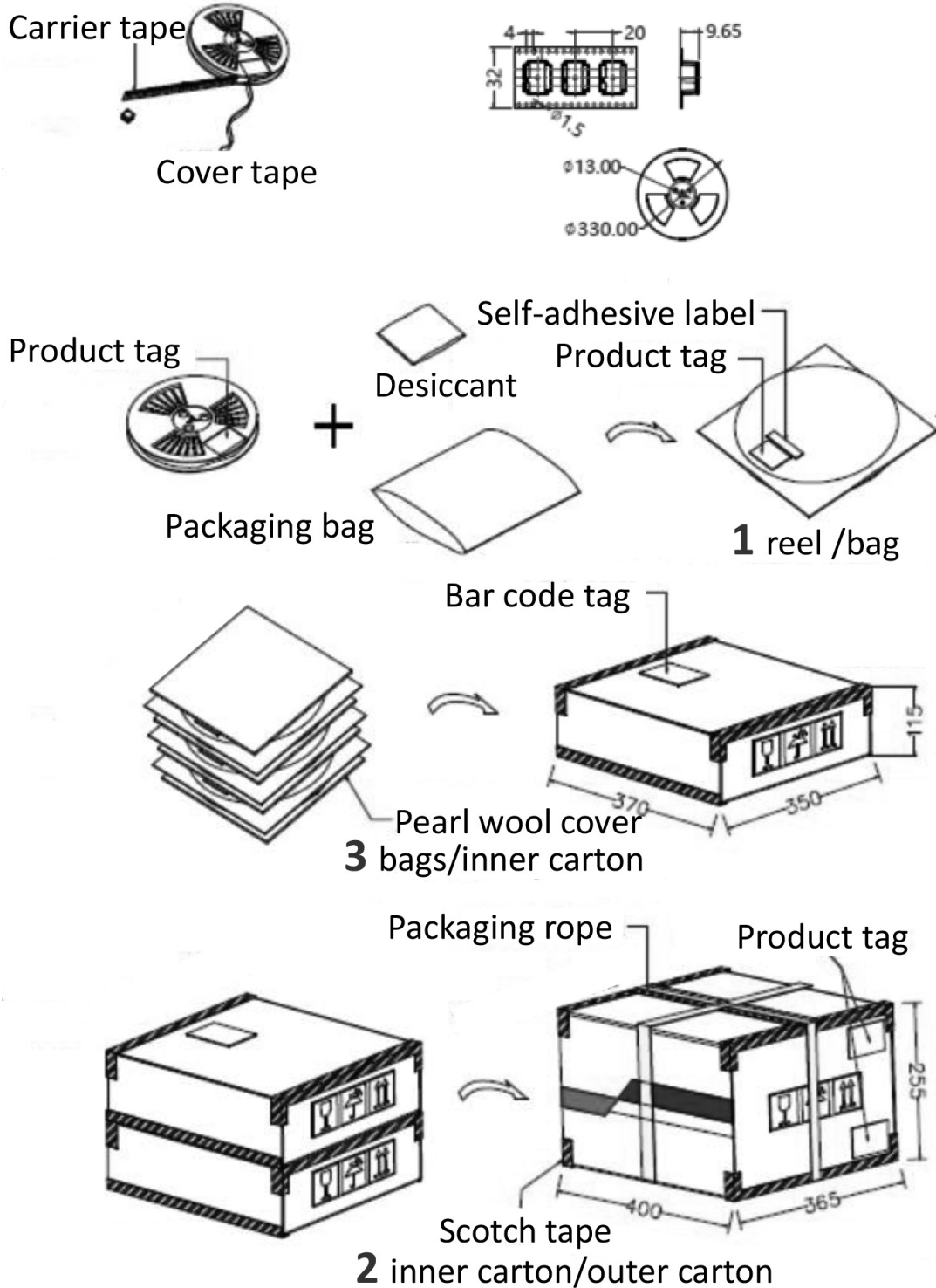

REVISION HISTORY

rev.	description	date
1.0	initial release	09/12/2018

The revision history provided is for informational purposes only and is believed to be accurate.



CUI INC[®]

Headquarters
20050 SW 112th Ave.
Tualatin, OR 97062
800.275.4899

Fax 503.612.2383
cui.com
techsupport@cui.com

CUI offers a two (2) year limited warranty. Complete warranty information is listed on our website.

CUI reserves the right to make changes to the product at any time without notice. Information provided by CUI is believed to be accurate and reliable. However, no responsibility is assumed by CUI for its use, nor for any infringements of patents or other rights of third parties which may result from its use.

CUI products are not authorized or warranted for use as critical components in equipment that requires an extremely high level of reliability. A critical component is any component of a life support device or system whose failure to perform can be reasonably expected to cause the failure of the life support device or system, or to affect its safety or effectiveness.

Mouser Electronics

Authorized Distributor

Click to View Pricing, Inventory, Delivery & Lifecycle Information:

[CUI Inc.:](#)

[V78E05-1000-SMT-TR](#) [V78E01-1000-SMT-TR](#) [V78E06-1000-SMT-TR](#) [V78E09-1000-SMT-TR](#) [V78E12-1000-SMT-TR](#)
[V78E03-1000-SMT-TR](#) [V78E02-1000-SMT-TR](#)