

## Shape 1:1

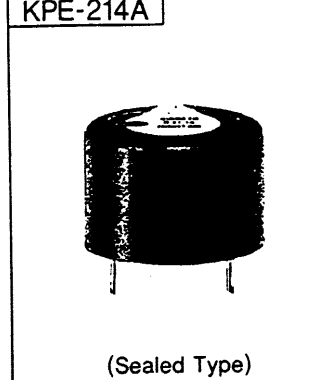

Model Number	KPE-204	KPE-204A	KPE-214	KPE-214A
Oscillating Frequency (KHz)	3.4 ± 0.5	3.4 ± 0.5	3.4 ± 0.5	3.4 ± 0.5
Operating Voltage (VDC)	3~20	3~20	3~20	3~20
Current Consumption at 12VDC (mA, maximum)	9	9	9	9
Sound Pressure Level at 30cm/12VDC (dB, minimum)	86	93	86	93
Tone	Continuous	Continuous	Continuous	Continuous
Operating Temperature ( °C )	-20~+60	-20~+60	-20~+60	-20~+60
Storage Temperature ( °C )	-30~+70	-30~+70	-30~+70	-30~+70
Weight (Gram)	5	5	4.6	5.5
Packing Quantity (PCS/BOX)	250	250	250	250

## Dimension

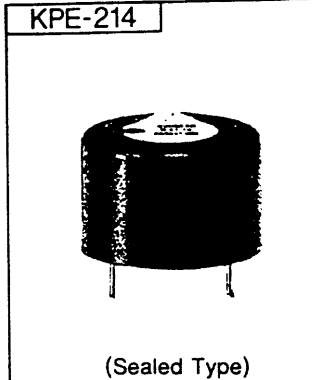
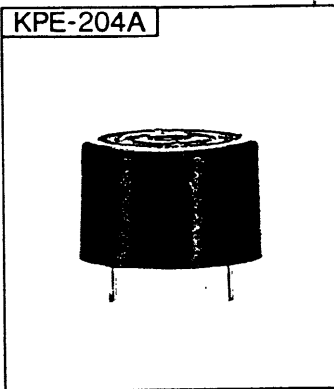
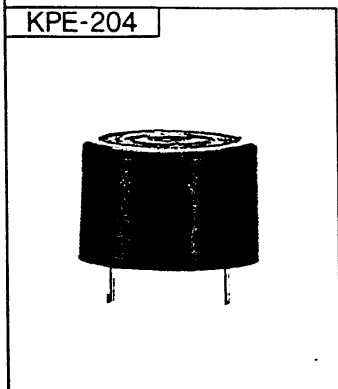
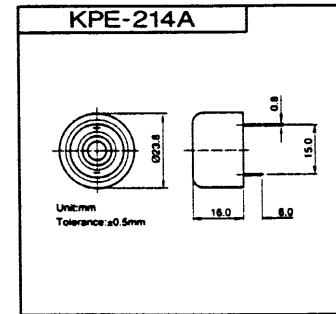
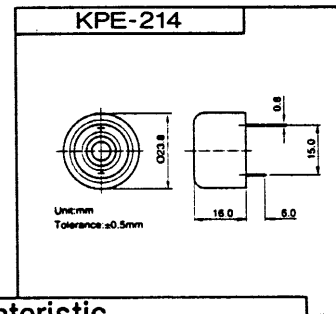
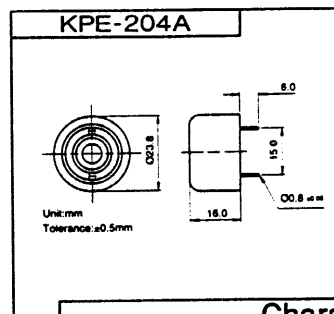
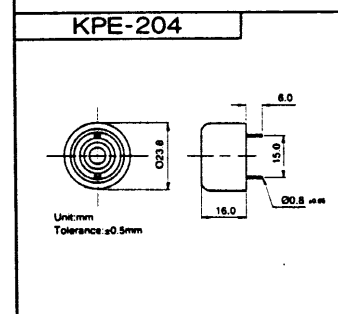

## Characteristic

