

Kyocera's series of Multilayer Ceramic Chip Capacitors are designed to meet a wide variety of needs. We offer a complete range of products for both general and specialized applications, including CM series for general-purpose, CT series for low profile, CA series for arrays, CL series for ICs, CF series for high-voltage, and DM series for automotive.

Features

- We have factories worldwide in order to supply our global customer bases quickly and efficiently and to maintain our reputation as one of the highest-volume producers in the industry.
- All our products are highly reliable due to their monolithic structure of high-purity and superfine uniform ceramics and their integral internal electrodes.
- By combining superior manufacturing technology and materials with high dielectric constants, we produce extremely compact components with exceptional specifications.
- Our stringent quality control in every phase of production from material procurement to shipping ensures consistent manufacturing and super quality.
- Kyocera components are available in a wide choice of dimensions, temperature characteristics, rated voltages, and terminations to meet specific configurational requirements.

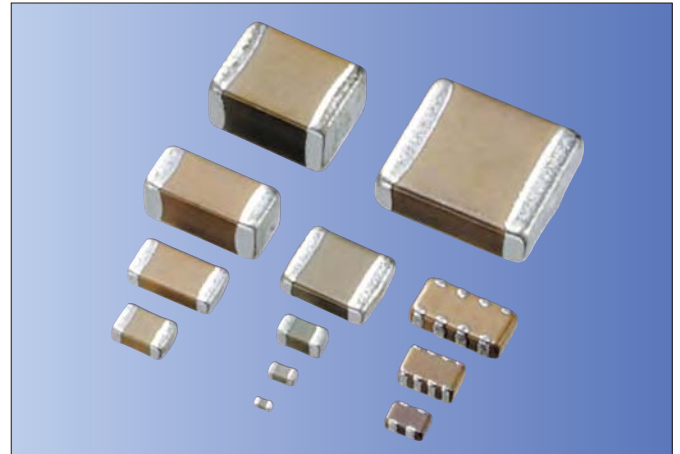

Pb Free

RoHS Compliant

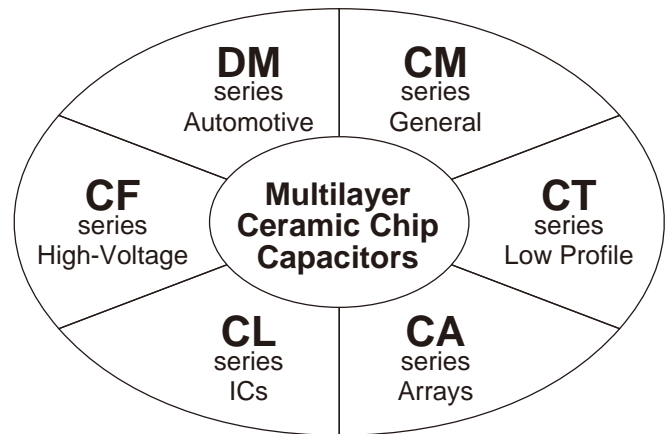

Structure

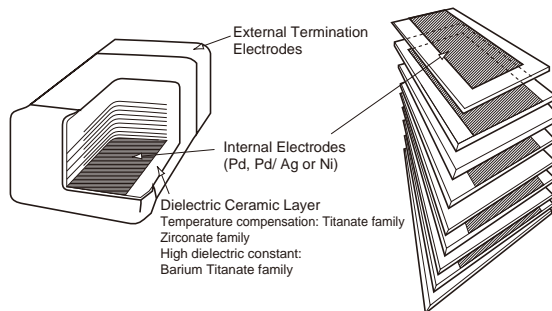

Nickel Barrier Termination Products

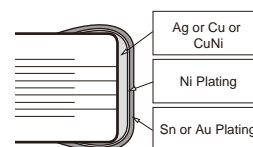

Tape and Reel



Bulk Case

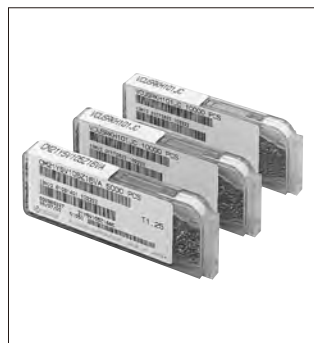

Please contact your local AVX, Kyocera sales office or distributor for specifications not covered in this catalog.

Our products are continually being improved. As a result, the capacitance range of each series is subject to change without notice. Please contact an sales representative to confirm compatibility with your application.

Kyocera Ceramic Chip Capacitors are available for different applications as classified below:

Series	Dielectric Options	Typical Applications	Features	Terminations	Available Size
CM	C0G (NP0) X5R X7R *X6S *X7S Y5V	General purpose	Wide cap range	Nickel barrier	01005, 0201, 0402 0603, 0805, 1206 1210, 1812
CT	X5R X7R Y5V	IC card (Decoupling)	Low profile	Nickel barrier	0201, 0402, 0603 0805, 1206, 1210
CA	C0G (NP0) X5R, X7R	Digital signal Pass line	Reduction in placing cost	Nickel barrier	0405, 0508
CL	X7S	ICs (Decoupling)	Low inductance	Nickel barrier	0204, 0306
CF	C0G (NP0) X7R	High voltage & Power circuits	High voltage 250VDC, 630VDC 1000VDC, 2000VDC 3000VDC, 4000VDC	Nickel barrier	0805, 1206, 1210 1812, 2208, 1808 2220
DM	X7R	Automotive	Thermal shock Resistivity High reliability	Nickel barrier	0603,0805,1206

* Option

* Negative temperature coefficient dielectric types are available on request.

Dimensions

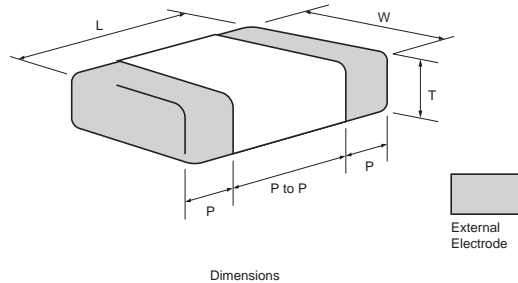

Tape & Reel

Size Code	EIA CODE	JIS CODE	Dimensions (mm)					
			L	W	T max.	P min.	P max.	P to P min.
02	01005	0402	0.4±0.02	0.2±0.02	0.22	0.07	0.14	0.13
03	0201	0603	0.6±0.03	0.3±0.03	0.33	0.13	0.23	0.20
05	0402	1005	1.0±0.05	0.5±0.05	0.55	0.15	0.35	0.30
105	0603	1608	1.6±0.10	0.8±0.10	0.90	0.20	0.60	0.50
21	0805	2012	2.0±0.10	1.25±0.10	1.35	0.20	0.75	0.70
316	1206	3216	3.2±0.20	1.60±0.15	1.75	0.30	0.85	1.40
32	1210	3225	3.2±0.20	2.50±0.20	2.70	0.30	1.00	1.40
42	1808	4520	4.5±0.20	2.00±0.20	2.20	0.15	0.85	2.60
43	1812	4532	4.5±0.30	3.20±0.20	3.00	0.30	1.10	2.00
52	2208	5720	5.7±0.40	2.00±0.20	2.20	0.15	0.85	4.20
55	2220	5750	5.7±0.40	5.00±0.40	2.80	0.30	1.40	2.50

- T (Thickness) depends on capacitance value.
Standard thickness is shown on the appropriate product pages.
- CA series and CL series: Please refer applicable page.
- As for the size of the product specified individually, please contact us.

Bulk Case

Size Code	EIA CODE	JIS CODE	Dimensions (mm)					
			L	W	T	P min.	P max.	P to P min.
05	0402	1005	1.0±0.05	0.5±0.05	0.5±0.05	0.15	0.35	0.30
105	0603	1608	1.6±0.07	0.8±0.07	0.8±0.07	0.20	0.60	0.50
21	0805	2012	2.0±0.1	1.25±0.1	1.25±0.1	0.20	0.75	0.70

Note) Regarding support for Bulk cases, please contact us for further information.

KYOCERA PART NUMBER

CM 21 X7R 104 K 50 A T

SERIES CODE

CM = General Purpose CL = ICs
 CT = Low Profile CF = High Voltage
 CA = Arrays DM = Automotive

SIZE CODE

SIZE	EIA	(JIS)	SIZE	EIA	(JIS)	SIZE	EIA	(JIS)			
02	=	01005	(0402)	32	=	1210	(3225)	D11	=	0405	(1014)/ 2 cap
03	=	0201	(0603)	42	=	1808	(4520)	F12	=	0508	(1220)/ 4 cap
05	=	0402	(1005)	43	=	1812	(4532)				
105	=	0603	(1608)	52	=	2208	(5720)				
21	=	0805	(2012)	55	=	2220	(5750)				
316	=	1206	(3216)								

DIELECTRIC CODE

CODE EIA CODE
 CG = C0G (NPO) X7S = X7S (Option)
 X5R = X5R X6S = X6S (Option)
 X7R = X7R Y5V = Y5V
 Negative temperature coefficient dielectric types are available on request.

CAPACITANCE CODE

Capacitance expressed in pF.
 Two significant digits plus number of zeros.
 For Values < 10pF, Letter R denotes decimal point,
 eg. 100000pF = 104 1.5pF = 1R5
 0.1µF = 104 0.5pF = R50
 4700pF = 472 100µF = 107

TOLERANCE CODE

A = ±0.05pF (option) D = ±0.5pF J = ±5% Z = -20 to +80%
 B = ±0.1pF F = ±1pF K = ±10%
 C = ±0.25pF G = ±2% (option) M = ±20%

VOLTAGE CODE

04 = 4VDC	100 = 100VDC	1000 = 1000VDC
06 = 6.3VDC	250 = 250VDC	2000 = 2000VDC
10 = 10VDC	400 = 400VDC	3000 = 3000VDC
16 = 16VDC	630 = 630VDC	4000 = 4000VDC
25 = 25VDC		
35 = 35VDC		
50 = 50VDC		

TERMINATION CODE

A = Nickel Barrier/ Tin K = Nickel Barrier/ Au

PACKAGING CODE

B = Bulk	L = 13" Reel Taping & 4mm Cavity pitch
C = Bulk Cassette (option)	H = 7" Reel Taping & 2mm Cavity pitch
T = 7" Reel Taping & 4mm Cavity pitch	N = 13" Reel Taping & 2mm Cavity pitch
Q = 7" Reel Taping & 1mm Cavity pitch	

OPTION

Thickness max. value is indicated in CT series
 EX. 125 → 1.25mm max.
 095 → 0.95mm max.

Temperature Compensation Type

Dielectric Value (pF)	C0G (NPO) 0 ppm/ °C	U Δ (N750) -750 ppm/ °C	SL +350 to -1000ppm/ °C
0.5 to 2.7	CK	UK	SL
3.0 to 3.9	CJ	UJ	SL
4.0 to 9.0	CH	UJ	SL
≥ 10	CG	UJ	SL

K = ± 250 ppm/ °C, J = ± 120 ppm/ °C, H = ± 60 ppm/ °C, G = ± 30 ppm/ °C
 e.g. CG = 0 ± 30 ppm/ °C

Note: All parts of C0G will be marked as "CG" but will conform to the above table.

High Dielectric Constant Type

EIA Dielectric	Temperature Range	ΔC max.
X5R	-55 to 85°C	$\pm 15\%$
X7R	-55 to 125°C	
*X7S	-55 to 125°C	$\pm 22\%$
*X6S	-55 to 105°C	
Y5V	-30 to 85°C	-82 to +22%

* option

Available Tolerances

Dielectric materials, capacitance values and tolerances are available in the following combinations only:

EIA Dielectric	Tolerance	Capacitance
C0G	C = ± 0.25 pF D = ± 0.50 pF F = ± 1 pF	*1 <10pF
	*3 A = ± 0.05 pF B = ± 0.1 pF	<0.5pF ≤ 5 pF
	*3 G = $\pm 2\%$ J = $\pm 5\%$ K = $\pm 10\%$	≥ 10 pF E12 Series
*3 X6S X5R *3 X7S X7R	*2 K = $\pm 10\%$ M = $\pm 20\%$	*4 E3 Series
Y5V	Z = -20% to +80%	E3 Series

Note:

*1 Nominal values below 10pF are available in the standard values of 0.5pF, 1.0pF, 1.5pF, 2.0pF, 3.0pF, 4.0pF, 5.0pF, 6.0pF, 7.0pF, 8.0pF, 9.0pF

*2 J = $\pm 5\%$ for X7R (X5R) is available on request.

*3 option

*4 E6 series is available on request.

E Standard Number

E3	E6	E12	E24 (Option)		
1.0	1.0	1.0	1.0	1.1	
		1.2	1.2	1.3	
	1.5	1.5	1.5	1.6	
		1.8	1.8	2.0	
2.2	2.2	2.2	2.2	2.4	
		2.7	2.7	3.0	
	3.3	3.3	3.3	3.6	
		3.9	3.9	4.3	
		4.7	4.7	4.7	5.1
			5.6	5.6	6.2
4.7	6.8	6.8	6.8	7.5	
		8.2	8.2	9.1	

Features

We offer a diverse product line ranging from ultra-compact (0.4x0.2mm) to large (4.5x3.2mm) components configured for a variety of temperature characteristics, rated voltages, and packages. We offer the choice and flexibility for almost any applications.

Applications

This standard type is ideal for use in a wide range of applications, from commercial to industrial equipment.

Temperature Compensation Dielectric

Size (EIA Code)	CM02 (01005)	CM03 (0201)			CM05 (0402)			CM105 (0603)	CM21 (0805)						
Temperature	CΔ*1	CΔ*1		UΔ*2	SL	CΔ*1	UΔ*2	SL	CΔ*1	CΔ*1					
Rated Voltage (VDC) Capacitance (pF)	16	25	50	16	25	25	50	50	50	50	100	16	25	50	100
R20 0.2	A	B	B	B	B	B	C	C	C	D	D				
R50 0.5															
1R0 1.0															
1R5 1.5															
2.0															
3.0															
4.0															
5.0															
6.0															
7.0															
8.0															
9.0															
100 10															
120 12															
15 15															
18 18															
22 22															
27 27															
33 33															
39 39															
47 47															
56 56															
68 68															
82 82															
101 100															
121 120															
150 150															
180 180															
220 220															
270 270															
330 330															
390 390															
470 470															
560 560															
680 680															
820 820															
102 1000															
122 1200															
1500 1500															
1800 1800															
2200 2200															
2700 2700															
3300 3300															
3900 3900															
4700 4700															
5600 5600															
6800 6800															
8200 8200															
103 10000															
123 12000															
15000 15000															
18000 18000															

* E24 series is available on request.

Optional Spec.

*1: CG, CH, CJ, CK

*2: UJ, UK

Thickness and standard package quantity

Size (EIA Code)	02 (01005)		03 (0201)		05 (0402)		105 (0603)		21, 316, 32 (0805) (1206) (1210)					
Thickness (mm)	A	A	B	B	C	C	D	D	E	F	G	H	I	
Thickness (mm)	0.2±0.02	0.2±0.02	0.3±0.03	0.3±0.03	0.5±0.05	0.5±0.05	0.8±0.1	0.8±0.1	0.6±0.1	0.85±0.1	1.15±0.1	1.25±0.1	1.4 max.	
Taping (180 dia reel)	40kp (P8/1)	20kp (P8/2)	35kp (P8/1)	15kp (P8/2)	30kp (P8/1)	10kp (P8/2)	8kp (P8/2)	4kp (P8/4)	4kp (P8/4)	4kp (P8/4)	4kp (P8/4)	3kp (E8/4)	3kp (E8/4)	3kp (E8/4)
Taping (330 dia reel)	—	50kp (P8/2)	—	50kp (P8/2)	—	50kp (P8/2)	20kp (P8/2)	10kp (P8/4)	10kp (P8/4)	10kp (P8/4)	10kp (E8/4)	10kp (E8/4)	10kp (E8/4)	

Size (EIA Code)	21, 316, 32 (0805) (1206) (1210)				43 (1812)			
Thickness (mm)	J	K	L	M	K	L	M	N
Thickness (mm)	1.6 max.	1.6±0.15	2.0±0.2	2.5±0.2	1.6±0.15	2.0±0.2	2.5±0.2	2.8±0.2
Taping (180 dia reel)	2.5kp (E8/4)	2.5kp (E8/4)	2kp (E8/4)	1kp (E8/4)	1kp (E12/4)	1kp (E12/4)	0.5kp (E12/4)	0.5kp (E12/4)
Taping (330 dia reel)	5kp (E8/4)	5kp (E8/4)	5kp (E8/4)	4kp (E8/4)	—	—	—	—

Note: Taping denotes the quantity packaged per reel (kp means 1000 pcs.). P8 in parenthesis denotes 8mm width paper tape; E8 denotes 8mm width plastic tape; E12 denotes 12mm width plastic tape. "/1" after slash in parenthesis denotes 1mm pitch; "/2" does 2mm pitch; "/4" does 4mm pitch.

X5R Dielectric

Size (EIA Code)	CM02 (01005)		CM03 (0201)			CM05 (0402)					CM105 (0603)					CM21 (0805)									
	Rated Voltage (VDC)	Capacitance (pF)	6.3	6.3	10	16	25	4	6.3	10	16	25	50	6.3	10	16	25	50	4	6.3	10	16	25	50	
101	100																								
151	150																								
	220																								
	330																								
	470																								
102	680																								
	1000																								
152	1500																								
	2200																								
	3300																								
	4700																								
103	6800																								
	10000																								
153	15000																								
	22000																								
	33000																								
	47000																								
104	68000																								
	100000																								
105	220000																								
	470000																								
	1000000																								
106	2200000																								
	4700000																								
	10000000																								
	22000000																								

Size (EIA Code)	CM316 (1206)					CM32 (1210)					CM43 (1812)				
	Rated Voltage (VDC)	Capacitance (pF)	6.3	10	16	25	50	4	6.3	10	16	25	50	6.3	50
105	220000														
	470000														
	1000000														
106	2200000														
	4700000														
	10000000														
107	22000000														
	47000000														
	100000000														

Optional Spec.

i : The size tolerance is ±0.15. And please refer *17 and *18 in Page 24 for test condition.
 ii : The size tolerance is ±0.20. And please refer *17 and *18 in Page 24 for test condition.

Thickness and standard package quantity

Size (EIA Code)	02 (01005)		03 (0201)		05 (0402)		105 (0603)		21, 316, 32 (0805) (1206) (1210)					
	Thickness (mm)	A	A	B	B	C	C	D	D	E	F	G	H	I
	0.2±0.02	0.2±0.02	0.3±0.03	0.3±0.03	0.5±0.05	0.5±0.05	0.8±0.1	0.8±0.1	0.6±0.1	0.85±0.1	1.15±0.1	1.25±0.1	1.4 max.	
Taping (180 dia reel)	40kp (P8/1)	20kp (P8/2)	35kp (P8/1)	15kp (P8/2)	30kp (P8/1)	10kp (P8/2)	8kp (P8/2)	4kp (P8/4)	4kp (P8/4)	4kp (P8/4)	4kp (P8/4)	3kp (E8/4)	3kp (E8/4)	3kp (E8/4)
Taping (330 dia reel)	—	50kp (P8/2)	—	50kp (P8/2)	—	50kp (P8/2)	20kp (P8/2)	10kp (P8/4)	10kp (P8/4)	10kp (P8/4)	10kp (P8/4)	10kp (E8/4)	10kp (E8/4)	10kp (E8/4)

Size (EIA Code)	21, 316, 32 (0805) (1206) (1210)				43 (1812)			
	Thickness (mm)	J	K	L	M	K	L	M
	1.6 max.	1.6±0.15	2.0±0.2	2.5±0.2	1.6±0.15	2.0±0.2	2.5±0.2	2.8±0.2
Taping (180 dia reel)	2.5kp (E8/4)	2.5kp (E8/4)	2kp (E8/4)	1kp (E8/4)	1kp (E12/4)	1kp (E12/4)	0.5kp (E12/4)	0.5kp (E12/4)
Taping (330 dia reel)	5kp (E8/4)	5kp (E8/4)	5kp (E8/4)	4kp (E8/4)	—	—	—	—

Note: Taping denotes the quantity packaged per reel (kp means 1000 pcs.). P8 in parenthesis denotes 8mm width paper tape; E8 denotes 8mm width plastic tape; E12 denotes 12mm width plastic tape. "/1" after slash in parenthesis denotes 1mm pitch; "/2" does 2mm pitch; "/4" does 4mm pitch.

X7R, Dielectric

Size (EIA Code)	CM03 (0201)			CM05 (0402)			CM105 (0603)						CM21 (0805)						
Rated Voltage (VDC)	10	16	25	16	25	50	6.3	10	16	25	50	100	6.3	10	16	25	50	100	
Capacitance (pF)	101	151	220	330	470	680	1000	1500	2200	3300	4700	6800	10000	15000	22000	33000	47000	68000	100000
103																			
153																			
104																			
105																			
106																			

Size (EIA Code)	CM316 (1206)						CM32 (1210)					CM43 (1812)	
Rated Voltage (VDC)	6.3	10	16	25	50	100	10	16	25	50	100	50	100
Capacitance (pF)	47000	68000	100000	220000	470000	1000000	2200000	4700000	10000000	22000000	47000000	100000000	220000000
104													
105													
106													

Optional Spec.

Y5V Dielectric

Size (EIA Code)	CM03 (0201)		CM05 (0402)				CM105 (0603)				CM21 (0805)				CM316 (1206)			CM32 (1210)		
Rated Voltage (VDC)	6.3	10	10	16	25	50	10	16	25	50	10	16	25	50	10	16	25	10	16	25
Capacitance (pF)	102	151	220	330	470	1000	1500	2200	3300	4700	6800	10000	15000	22000	33000	47000	68000	100000	150000	220000
103																				
104																				
105																				
106																				
107																				
108																				

Thickness and standard package quantity

Size (EIA Code)	02 (01005)		03 (0201)		05 (0402)		105 (0603)		21, 316, 32 (0805) (1206) (1210)					
Thickness (mm)	A	A	B	B	C	C	D	D	E	F	G	H	I	
	0.2±0.02	0.2±0.02	0.3±0.03	0.3±0.03	0.5±0.05	0.5±0.05	0.8±0.1	0.8±0.1	0.6±0.1	0.85±0.1	1.15±0.1	1.25±0.1	1.4 max.	
Taping (180 dia reel)	40kp (P8/1)	20kp (P8/2)	35kp (P8/1)	15kp (P8/2)	30kp (P8/1)	10kp (P8/2)	8kp (P8/2)	4kp (P8/4)	4kp (P8/4)	4kp (P8/4)	3kp (E8/4)	3kp (E8/4)	3kp (E8/4)	
Taping (330 dia reel)	—	50kp (P8/2)	—	50kp (P8/2)	—	50kp (P8/2)	20kp (P8/2)	10kp (P8/4)	10kp (P8/4)	10kp (P8/4)	10kp (E8/4)	10kp (E8/4)	10kp (E8/4)	

Size (EIA Code)	21, 316, 32 (0805) (1206) (1210)				43 (1812)			
Thickness (mm)	J	K	L	M	K	L	M	N
	1.6 max.	1.6±0.15	2.0±0.2	2.5±0.2	1.6±0.15	2.0±0.2	2.5±0.2	2.8±0.2
Taping (180 dia reel)	2.5kp (E8/4)	2.5kp (E8/4)	2kp (E8/4)	1kp (E8/4)	1kp (E12/4)	1kp (E12/4)	0.5kp (E12/4)	0.5kp (E12/4)
Taping (330 dia reel)	5kp (E8/4)	5kp (E8/4)	5kp (E8/4)	4kp (E8/4)	—	—	—	—

Note: Taping denotes the quantity packaged per reel (kp means 1000 pcs.). P8 in parenthesis denotes 8mm width paper tape; E8 denotes 8mm width plastic tape; E12 denotes 12mm width plastic tape. "/1" after slash in parenthesis denotes 1mm pitch; "/2" does 2mm pitch; "/4" does 4mm pitch.

Capacitance-Temperature
(temperature compensation type)

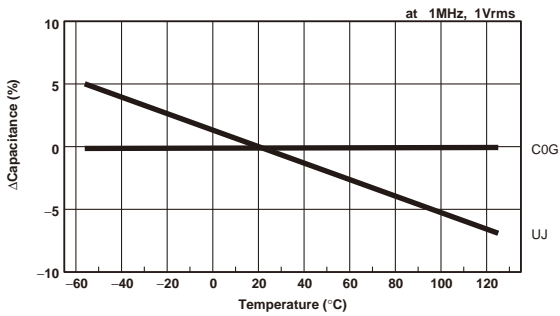

Aging
(change of capacitance over time)

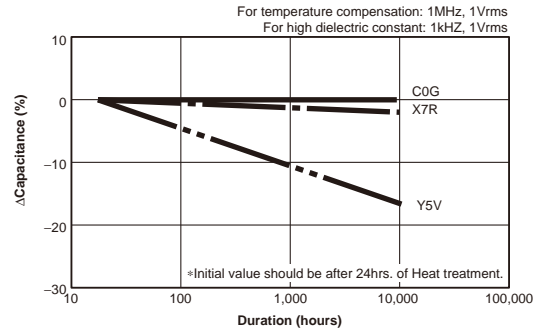

Capacitance-Temperature
(high dielectric constant type)

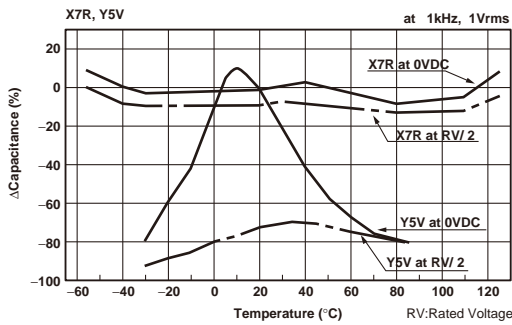

Impedance-Frequency

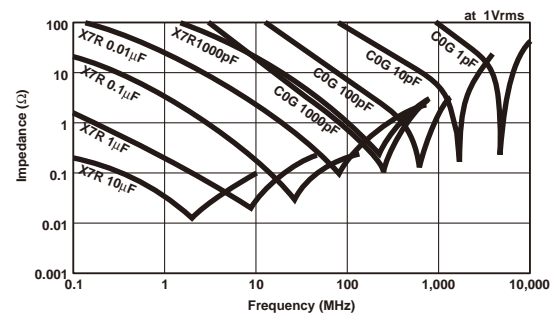

DC Bias

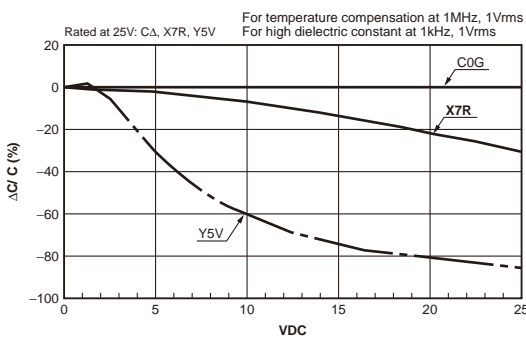

AC Voltage

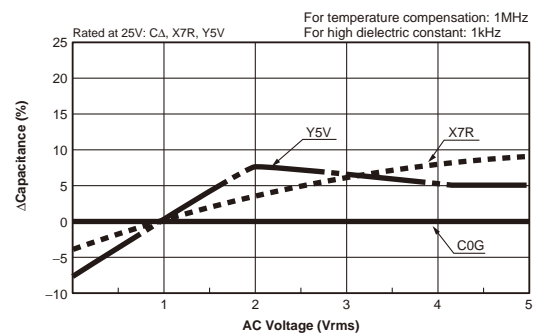

Please verify individual characteristics at the design stage to ensure total suitability.

Test Conditions and Specifications for Temperature Compensation type (C Δ to U Δ • SL Characteristics)

Test Items		Specifications (C: nominal capacitance)	Test Conditions									
Capacitance Value		Within tolerance	<table border="1"> <thead> <tr> <th>Capacitance</th> <th>Frequency</th> <th>Volt</th> </tr> </thead> <tbody> <tr> <td>C\leq1000pF</td> <td>1MHz\pm10%</td> <td>0.5 to 5Vrms</td> </tr> <tr> <td>C$>$1000pF</td> <td>1kHz\pm10%</td> <td></td> </tr> </tbody> </table>	Capacitance	Frequency	Volt	C \leq 1000pF	1MHz \pm 10%	0.5 to 5Vrms	C $>$ 1000pF	1kHz \pm 10%	
Capacitance	Frequency	Volt										
C \leq 1000pF	1MHz \pm 10%	0.5 to 5Vrms										
C $>$ 1000pF	1kHz \pm 10%											
Q		C \geq 30pF: Q \geq 1000 C $<$ 30pF: Q \geq 400+20C										
Insulation resistance (IR) (*1)		10,000M Ω or 500M Ω • μ F, whichever is less	Measured after the rated voltage is applied for 1 minute at normal room temperature and humidity. (*2)									
Dielectric resistance (*1)		No problem observed	(*3) Apply 3 times of the rated voltage for 1 to 5 seconds.									
Appearance		No problem observed	Microscope (10 \times magnification)									
Termination strength		No problem observed	Apply a sideward force of 500g (5N) (*4) to a PCB-mounted sample.									
Bending strength		No mechanical damage at 1mm bent	Glass epoxy PCB: t = 0.8mm thickness for 01005, 0201 and 0402 sizes; t = 1.6mm thickness for other sizes. Fulcrum spacing: 90mm Duration time: 10 seconds									
Vibration test	Appearance	No significant change is detected	Vibration frequency: 10 to 55 (Hz) Amplitude: 1.5mm Sweeping condition: 10 \rightarrow 55 \rightarrow 10Hz/ min. In X, Y and Z directions: 2 hours each Total 6 hours									
	Δ C	Within tolerance										
	Q	C \geq 30pF: Q \geq 1000 C $<$ 30pF: Q \geq 400+20C										
Soldering heat resistance	Appearance	No significant change is detected	Soak the sample in 260 \pm 5 $^{\circ}$ C solder for 10 \pm 0.5 seconds and place in a room at normal temperature and humidity; measure after 24 \pm 2 hours. (Preheating Conditions)									
	Δ C	Within \pm 2.5% or \pm 0.25pF, whichever is larger										
	Q	C \geq 30pF: Q \geq 1000 C $<$ 30pF: Q \geq 400+20C										
	IR (*1)	10,000M Ω or 500M Ω • μ F, whichever is smaller										
	Withstand voltage(*1)	Resists without problem										
Solderability		Solder coverage: 90% min.	Soaking Condition <table border="1"> <thead> <tr> <th>Order</th> <th>Temperature</th> <th>Time</th> </tr> </thead> <tbody> <tr> <td>1</td> <td>80 to 100$^{\circ}$C</td> <td>2 minutes</td> </tr> <tr> <td>2</td> <td>150 to 200$^{\circ}$C</td> <td>2 minutes</td> </tr> </tbody> </table>	Order	Temperature	Time	1	80 to 100 $^{\circ}$ C	2 minutes	2	150 to 200 $^{\circ}$ C	2 minutes
Order	Temperature	Time										
1	80 to 100 $^{\circ}$ C	2 minutes										
2	150 to 200 $^{\circ}$ C	2 minutes										
Temperature cycle	Appearance	No significant change is detected	(Cycle) Normal room temperature (3 min.) \rightarrow Lowest operation temperature (30 min.) \rightarrow Normal room temperature (3 min.) \rightarrow Highest operation temperature (30 min.) \rightarrow After five cycles, measure after 24 \pm 2 hours.									
	Δ C	Within \pm 2.5% or \pm 0.25pF, whichever is larger										
	Q	C \geq 30pF: Q \geq 1000 C $<$ 30pF: Q \geq 400+20C										
	IR (*1)	10,000M Ω or 500M Ω • μ F, whichever is smaller										
	Withstand voltage(*1)	Resists without problem										
Load humidity test (*5)	Appearance	No significant change is detected	After applying rated voltage for 500+24/ -0 hours in pre-condition at 40 \pm 2 $^{\circ}$ C, humidity 90 to 95%RH allow parts to stabilize for 24 \pm 2 hours, at room temperature before making measurements.									
	Δ C	Within \pm 7.5% or \pm 0.75pF, whichever is larger										
	Q	C \geq 30pF: Q \geq 200 C $<$ 30pF: Q \geq 100+10C/ 3										
	IR (*1)	500M Ω or 25M Ω • μ F, whichever is smaller										
High-temperature with loading	Appearance	No significant change is detected	After applying (*3) twice of the rated voltage at a temperature of 125 \pm 3 $^{\circ}$ C for 1000+48/ -0 hours, measure the sample after storing 24 \pm 2 hours.									
	Δ C	Within \pm 3% or \pm 0.3pF, whichever is larger										
	Q	C \geq 30pF: Q \geq 350 10pF \leq C $<$ 30pF: Q \geq 275+5C/ 2 C $<$ 10pF: Q \geq 200+10C										
	IR (*1)	1,000M Ω or 50M Ω • μ F, whichever is smaller										

*1 The charge and discharge current of the capacitor must not exceed 50mA.

*2 Apply 500V for 1 minute in case the rated voltage is 630V or higher.

*3 For the CF series, use 1.5 times for the rated voltage of 250V; use 1.2 times for the rated voltage exceeding 630V.

*4 2N for 0201 Size, 1N for 01005 Size

*5 Except CF series.

Test Conditions and Specifications for High Dielectric Type (X5R, X7R, Y5V)

Test Items	Specifications		Test Conditions									
	X5R/ X7R	Y5V										
Capacitance Value	Within tolerance		Practice pre-treatment (*8, *10) <table border="1"> <thead> <tr> <th>Capacitance</th> <th>Frequency</th> <th>Volt</th> </tr> </thead> <tbody> <tr> <td>C≤10μF</td> <td>1kHz±10%</td> <td>1.0±0.2Vrms</td> </tr> <tr> <td>C>10μF</td> <td>120Hz±10%</td> <td>0.5±0.2Vrms</td> </tr> </tbody> </table>	Capacitance	Frequency	Volt	C≤10μF	1kHz±10%	1.0±0.2Vrms	C>10μF	120Hz±10%	0.5±0.2Vrms
Capacitance	Frequency	Volt										
C≤10μF	1kHz±10%	1.0±0.2Vrms										
C>10μF	120Hz±10%	0.5±0.2Vrms										
tanδ (%)	2.5% max., 3.5% max. (*1), 5.0% max. (*2) 7.0% max. (*3), 7.5% max. (*4), 12.5% max. (*18)	5.0% max., 7.0% max. (*5) 9.0% max. (*6), 12.5% max. (*7)										
Insulation resistance (IR) (*11)	10,000MΩ or 500MΩ · μF, whichever is less (*19)		Measured after the rated voltage is applied for 1 minute at normal room temperature and humidity. (*12)									
Dielectric resistance (*11)	No problem observed		(*13) Apply 2.5 times of the rated voltage for 1 to 5 seconds.									
Appearance	No problem observed		Microscope (10×magnification)									
Termination strength (*14)	No problem observed		Apply a sideward force of 500g (5N) (*15) to a PCB-mounted sample.									
Bending strength test (*14)	No problem observed at 1mm bent		Glass epoxy PCB: t = 0.8mm thickness for 01005, 0201, 0402 and CA sizes; t = 1.6mm thickness for other sizes. Fulcrum spacing: 90mm Duration time: 10 seconds									
Vibration test	Appearance	No significant change is detected	Vibration frequency: 10 to 55 (Hz) Amplitude: 1.5mm Sweeping condition: 10→55→10Hz/ min. In X, Y and Z directions: 2 hours each Total 6 hours									
	ΔC	Within tolerance										
	tanδ (%)	Within tolerance										
Soldering heat resistance	Appearance	No significant change is detected	Practice pre-treatment (*8) Soak the sample in 260°C±5°C solder for 10±0.5 seconds and place in a room at normal temperature and humidity; measure after 24±2 hours. (Preheating Conditions) <table border="1"> <thead> <tr> <th>Order</th> <th>Temperature</th> <th>Time</th> </tr> </thead> <tbody> <tr> <td>1</td> <td>80 to 100°C</td> <td>2 minutes</td> </tr> <tr> <td>2</td> <td>150 to 200°C</td> <td>2 minutes</td> </tr> </tbody> </table>	Order	Temperature	Time	1	80 to 100°C	2 minutes	2	150 to 200°C	2 minutes
	Order	Temperature		Time								
	1	80 to 100°C		2 minutes								
	2	150 to 200°C		2 minutes								
	ΔC	Within ±7.5%		Within ±20%								
tanδ (%)	Within tolerance											
IR (*11)	10,000MΩ or 500MΩ · μF, whichever is smaller (*19)											
Withstand voltage (*11)	Resists without problem											
Solderability	Solder coverage: 90% min.		Soaking Condition <table border="1"> <thead> <tr> <th>Sn63 Solder</th> <th>Temperature</th> <th>Time</th> </tr> </thead> <tbody> <tr> <td>Sn63 Solder</td> <td>235±5°C</td> <td>2±0.5 sec.</td> </tr> <tr> <td>Sn-3Ag-0.5Cu</td> <td>245±5°C</td> <td>3±0.5 sec.</td> </tr> </tbody> </table>	Sn63 Solder	Temperature	Time	Sn63 Solder	235±5°C	2±0.5 sec.	Sn-3Ag-0.5Cu	245±5°C	3±0.5 sec.
	Sn63 Solder	Temperature	Time									
Sn63 Solder	235±5°C	2±0.5 sec.										
Sn-3Ag-0.5Cu	245±5°C	3±0.5 sec.										
Temperature cycle	Appearance	No significant change is detected	Practice pre-treatment (*8) (Cycle) Normal room temperature (3 min.) → Lowest operation temperature (30 min.) → Normal room temperature (3 min.) → Highest operation temperature (30 min.) → After five cycles, measure after 24±2hours.									
	ΔC	Within ±7.5%		Within ±20%								
	tanδ (%)	Within tolerance										
	IR (*11)	10,000MΩ or 500MΩ · μF, whichever is smaller (*19)										
	Withstand voltage (*11)	Resists without problem										
Load humidity test (*16)	Appearance	No significant change is detected	Practice pre-treatment (*9) After applying rated voltage at 40±2°C and humidity 90 to 95%RH, for 500+24/-0 hours and keep at room condition for 24±2 hours then measure and check the specification limits.									
	ΔC	Within ±12.5%		Within ±30%								
	tanδ (%)	200% max. of initial value		150% max. of initial value								
	IR (*11)	500MΩ or 25MΩ · μF, whichever is smaller										
High-temperature with loading	Appearance	No significant change is detected	Practice pre-treatment (*9) After applying twice (*17) of the rated voltage at the highest operating temperature for 1000+48/-0 hours, measure the sample after storing 24±2 hours.									
	ΔC	Within ±12.5%		Within ±30%								
	tanδ (%)	200% max. of initial value		150% max. of initial value								
	IR (*11)	1,000MΩ or 50MΩ · μF, whichever is smaller										

*1 Apply to X7R 16V/ 25V type.
 *2 Apply to X5R16V/ 25V type, X7R 6.3V/ 10V type.
 *3 Apply to X5R 10V type.
 *4 Apply to X5R 4V and 6.3V type.
 *5 Apply to 25V series of CM105Y5V154 or over, CM21Y5V105 or over, 316Y5V155 or over.
 *6 Apply to Y5V 16V type, CM32Y5V335 to 106 (25V Type).
 *7 Apply to Y5V 6.3V/ 10V type. Apply 16% max. to CM21Y5V106/ CM316Y5V226.
 *8 Keep specimen at 150°C+0/-10°C for one hour, leave specimen at room ambient for 24±2 hours.
 *9 Apply the same test condition for one hour, then leave the specimen at room ambient for 24±2 hours.

*10 Measurement condition 1kHz, 1Vrms for Y5V.
 *11 The charge/ discharge current of the capacitor must not exceed 50mA.
 *12 For the CF series over 630V, apply 500V for 1 minute at room ambient.
 *13 Use 1.5 times when the rated voltage is 250V or over.
 Use 1.2 times when the rated voltage is 630V or over.
 *14 Exclude CT series with thickness of less than 0.66mm and CA series.
 *15 2N for 0201 Size, 1N for 01005 Size
 *16 Except CF series.
 *17 Use 1.5 times when the rated voltage is 4V/ 6.3V/ 10V/ 250V and 100V (32X7R474/ 43X7R105/ 55X7R105).
 Use 1.5 times for the products marked with i and ii in the table of page 11.
 Use 1.2 times when the rated voltage is 630V or over.
 *18 Apply to the products marked with i and ii in the table of page 11.
 *19 100MΩ · μF for CF316X7R104/ 250V and CF43X7R474/ 250V.
 * The above test conditions and standards do not apply to products with optional specifications.

Tape and Reel

• Reel

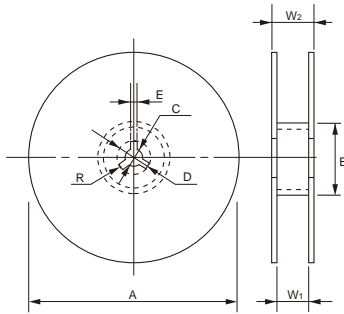

Reel

(Unit: mm)

Code Reel	A	B	C	D
7-inch Reel (CODE: T, H, Q)	180 ⁺⁰ / _{-2.0}	φ60 min.	13±0.5	21±0.8
13-inch Reel (CODE: L, N)	330±2.0	φ100±1.0		
Code Reel	E	W ₁	W ₂	R
7-inch Reel (CODE: T, H, Q)	2.0±0.5	10.0±1.5	16.5 max.	1.0
13-inch Reel (CODE: L, N)		9.5±1.0		

* Carrier tape width 8mm.

For size 42 (1808) or over, Tape width 12mm and W₁: 14±1.5, W₂: 18.4mm max.

F=1mm (02, 03, 05 Type)

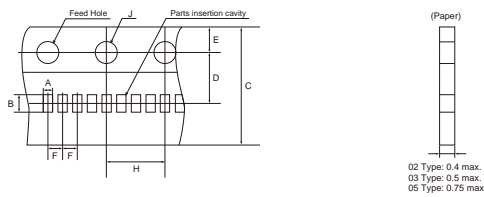

02 Type: 0.4 max.
03 Type: 0.5 max.
05 Type: 0.75 max.

F=2mm (03, 05, 105 Type)

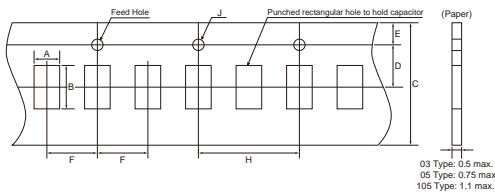

03 Type: 0.5 max.
05 Type: 0.75 max.
105 Type: 1.1 max.

F=4mm (105, D11, F12, 21, 316, 32, 42, 52 Type)

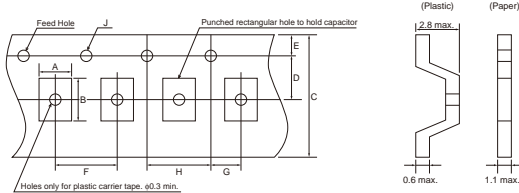

Holes only for plastic carrier tape: φ0.3 min.

(Plastic) 2.8 max.
0.6 max.
(Paper) 1.1 max.

F=8mm (43, 55 Type)

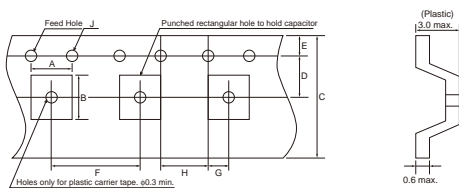

Holes only for plastic carrier tape: φ0.3 min.

(Plastic) 3.0 max.
0.6 max.

Bulk Case

(Unit: mm)

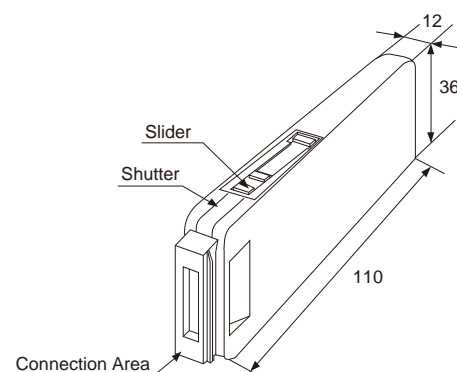

Carrier Tape

(Unit: mm)

Size (EIA Code)	A	B	F
02 (01005)	0.24±0.02	0.44±0.02	2.0±0.05
03 (0201)	0.37±0.03	0.67±0.03	2.0±0.05
05 (0402)	0.65±0.1	1.15±0.1	2.0±0.05
105 (0603)	1.0±0.2	1.8±0.2	4.0±0.1
21 (0805)	1.5±0.2	2.3±0.2	4.0±0.1
316 (1206)	2.0±0.2	3.6±0.2	4.0±0.1
32 (1210)	2.9±0.2	3.6±0.2	4.0±0.1
42 (1808)	2.4±0.2	4.9±0.2	4.0±0.1
43 (1812)	3.6±0.2	4.9±0.2	8.0±0.1
52 (2208)	2.4±0.2	6.0±0.2	4.0±0.1
55 (2220)	5.3±0.2	6.0±0.2	8.0±0.1
D11 (0405)	1.15±0.2	1.55±0.2	4.0±0.1
F12 (0508)	1.5±0.2	2.3±0.2	4.0±0.1

(Unit: mm)

F	Carrier Tape	C	D	E	G	H	J
1.0 ±0.05	1mm Paper	8.0 +0.3/-0.1	3.5 ±0.05	1.75 ±0.1	2.0 ±0.05	4.0 ±0.05	1.5 +0.1/-0
2.0 ±0.05	8mm Paper	8.0 ±0.3				4.0 ±0.05	
4.0 ±0.1	8mm Plastic	12.0 ±0.3	5.5 ±0.05	1.75 ±0.1	2.0 ±0.05	4.0 ±0.05	1.5 +0.1/-0
8.0 ±0.1	12mm Plastic					4.0 ±0.05	

Adhesive tape

- 1) The exfoliative strength when peeling off the top tape from the carrier tape by the method of the following figure shall be 0.1-0.7N.
- 2) When the top tape is peeled off, the adhesive stays on the top tape.
- 3) Chip capacitors will be in a state free without being stuck on the thermal adhesive tape.

Exfoliating angle: 165 to 180 degrees to the carrier tape.
Exfoliating speed: 300 mm/min.

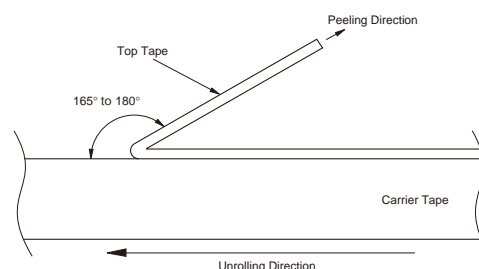

Circuit Design

1. Once application and assembly environments have been checked, the capacitor may be used in conformance with the rating and performance which are provided in both the catalog and the specifications. Use exceeding that which is specified may result in inferior performance or cause a short, open, smoking, or flaming to occur, etc.
2. Please consult the manufacturer in advance when the capacitor is used in devices such as: devices which deal with human life, i.e. medical devices; devices which are highly public orientated; and devices which demand a high standard of liability.
Accident or malfunction of devices such as medical devices, space equipment and devices having to do with atomic power could generate grave consequence with respect to human lives or, possibly, a portion of the public. Capacitors used in these devices may require high reliability design different from that of general purpose capacitors.
3. Please use the capacitors in conformance with the operating temperature provided in both the catalog and the specifications.
Be especially cautious not to exceed the maximum temperature. In the situation the maximum temperature set forth in both the catalog and specifications is exceeded, the capacitor's insulation resistance may deteriorate, power may suddenly surge and short-circuit may occur. The capacitor has a loss, and may self-heat due to equivalent series resistance when alternating electric current is passed therethrough. As this effect becomes especially pronounced in high frequency circuits, please exercise caution.
When using the capacitor in a (self-heating) circuit, please make sure the surface of the capacitor remains under the maximum temperature for usage. Also, please make certain temperature rises remain below 20°C.
4. Please keep voltage under the rated voltage which is applied to the capacitor. Also, please make certain the peak voltage remains below the rated voltage when AC voltage is super-imposed to the DC voltage.
In the situation where AC or pulse voltage is employed, ensure average peak voltage does not exceed the rated voltage.
Exceeding the rated voltage provided in both catalog and specifications may lead to defective withstanding voltage or, in worst case situations, may cause the capacitor to smoke or flame.
5. When the capacitor is to be employed in a circuit in which there is continuous application of a high frequency voltage or a steep pulse voltage, even though it is within the rated voltage, please inquire to the manufacturer.
In the situation the capacitor is to be employed using a high frequency AC voltage or a extremely fast rising pulse voltage, even though it is within the rated voltage, it is possible capacitor reliability will deteriorate.
6. It is a common phenomenon of high-dielectric products to have a deteriorated amount of static electricity due to the application of DC voltage. Due caution is necessary as the degree of deterioration varies depending on the quality of capacitor materials, capacity, as well as the load voltage at the time of operation.
7. Do not use the capacitor in an environment where it might easily exceed the respective provisions concerning shock and vibration specified in the catalog and specifications.
In addition, it is a common piezo phenomenon of high dielectric products to have some voltage due to vibration or to have noise due to voltage change. Please contact sales in such case.
8. If the electrostatic capacity value of the delivered capacitor is within the specified tolerance, please consider this when designing the respective product in order that the assembled product function appropriately.
9. Please contact us upon using conductive adhesives.

Storage

1. If the component is stored in minimal packaging (a heat-sealed or chuck-type plastic bag), the bag should be kept closed. Once the bag has been opened, reseal it or store it in a desiccator.
2. Keep storage place temperature +5 to +35 degree C, humidity 45 to 70% RH.
3. The storage atmosphere must be free of gas containing sulfur and chlorine. Also, avoid exposing the product to saline moisture. If the product is exposed to such atmospheres, the terminals will oxidize and solderability will be effected.
4. Precautions 1) to 3) apply to chip capacitors packaged in carrier tapes and bulk cases.
5. The solderability is assured for 12 months from our shipping date (six months for silver palladium) if the above storage precautions are followed.
6. Chip capacitors may crack if exposed to hydrogen (H₂) gas while sealed or if coated with silicon, which generates hydrogen gas.

Dimensions for recommended typical land

Since the amount of solder (size of fillet) to be used has direct influence on the capacitor after mounting, the sufficient consideration is necessary.

When the amounts of solder is too much, the stress that a capacitor receives becomes larger. It may become the cause of a crack in the capacitor. When the land design of printed wiring board is considered, it is necessary to set up the form and size of land pattern so that the amount of solder is suitable.

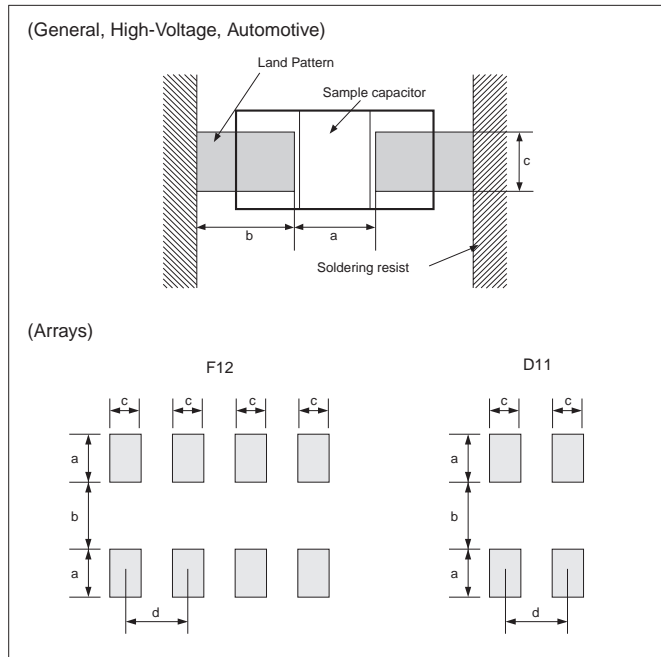

Design of printed circuit and Soldering

The recommended fillet height shall be 1/2 to 1/3 of the thickness of capacitors. When mounting two or more capacitors in the common land, it is necessary to separate the land with the solder resist strike so that it may become the exclusive land of each capacitor.

General, High-Voltage

(Unit: mm)

Size (EIA Code)	L×W	a	b	c
02 (01005)	0.4×0.2	0.13 to 0.20	0.12 to 0.18	0.20 to 0.23
03 (0201)	0.6×0.3	0.20 to 0.30	0.25 to 0.35	0.30 to 0.40
05 (0402)	1.0×0.5	0.30 to 0.50	0.35 to 0.45	0.40 to 0.60
105 (0603)	1.6×0.8	0.70 to 1.00	0.80 to 1.00	0.60 to 0.80
21 (0805)	2.0×1.25	1.00 to 1.30	1.00 to 1.20	0.80 to 1.10
316 (1206)	3.2×1.6	2.10 to 2.50	1.10 to 1.30	1.00 to 1.30
32 (1210)	3.2×2.5	2.10 to 2.50	1.10 to 1.30	1.90 to 2.30
42 (1808)	4.5×2.0	2.50 to 3.20	1.80 to 2.30	1.50 to 1.80
43 (1812)	4.5×3.2	2.50 to 3.20	1.80 to 2.30	2.60 to 3.00
52 (2208)	5.7×2.0	4.20 to 4.70	2.00 to 2.50	1.50 to 1.80
55 (2220)	5.7×5.0	4.20 to 4.70	2.00 to 2.50	4.20 to 4.70

Automotive

(Unit: mm)

Size (EIA Code)	L×W	a	b	c
105 (0603)	1.6×0.8	0.60 to 0.90	0.80 to 1.00	0.70 to 1.00
21 (0805)	2.0×1.25	0.90 to 1.20	0.80 to 1.20	0.90 to 1.40
316 (1206)	3.2×1.6	1.40 to 1.90	1.00 to 1.30	1.30 to 1.80

Arrays

(Unit: mm)

	a	b	c	d
F12 (0508)	0.5	0.5	0.3	0.5
D11 (0405)	0.69	0.28	0.3	0.64

Ideal Solder Height

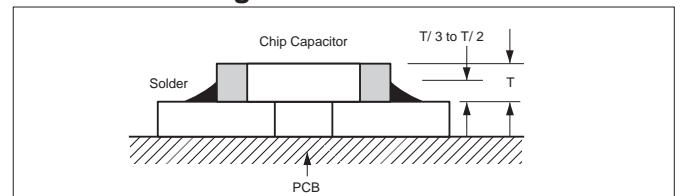

Item	Not recommended example	Recommended example/ Separated by solder
Multiple parts mount		
Mount with leaded parts		
Wire soldering after mounting		
Overview		

Mounting Design

The chip could crack if the PCB warps during processing after the chip has been soldered.

Recommended chip position on PCB to minimize stress from PCB warpage



Actual Mounting

- 1) If the position of the vacuum nozzle is too low, a large force may be applied to the chip capacitor during mounting, resulting in cracking.
- 2) During mounting, set the nozzle pressure to a static load of 100 to 300 gf.
- 3) To minimize the shock of the vacuum nozzle, provide a support pin on the back of the PCB to minimize PCB flexure.

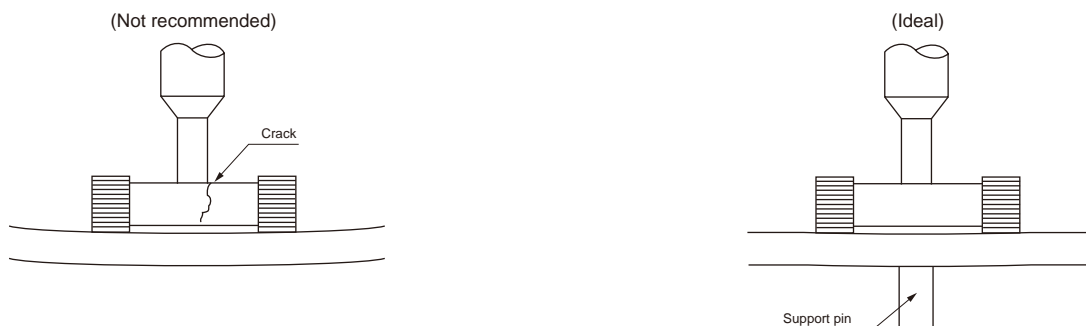

- 4) Bottom position of pick up nozzle should be adjusted to the top surface of a substrate which camber is corrected.
- 5) To reduce the possibility of chipping and cracks, minimize vibration to chips stored in a bulk case.
- 6) The discharge pressure must be adjusted to the part size. Verify the pressure during setup to avoid fracturing or cracking the chips capacitors.

Resin Mold

- 1) If a large amount of resin is used for molding the chip, cracks may occur due to contraction stress during curing. To avoid such cracks, use a low shrinkage resin.
- 2) The insulation resistance of the chip will degrade due to moisture absorption. Use a low moisture absorption resin.
- 3) Check carefully that the resin does not generate a decomposition gas or reaction gas during the curing process or during normal storage. Such gases may crack the chip capacitor or damage the device itself.

Soldering Method

- 1) Ceramic is easily damaged by rapid heating or cooling. If some heat shock is unavoidable, preheat enough to limit the temperature difference (Delta T) to within 130 degree Celsius.
- 2) The product size 1.0x0.5mm to 3.2x1.6mm can be used in reflow and wave soldering, and the product size of bigger than 3.2x1.6mm, or smaller than 1.0x0.5mm, and capacitor arrays can be used in reflow.
 Circuit shortage and smoking can be created by using capacitors which are used neglecting the above caution.
- 3) Please see our recommended soldering conditions.
- 4) In case of using Sn-Zn Solder, please contact us in advance.

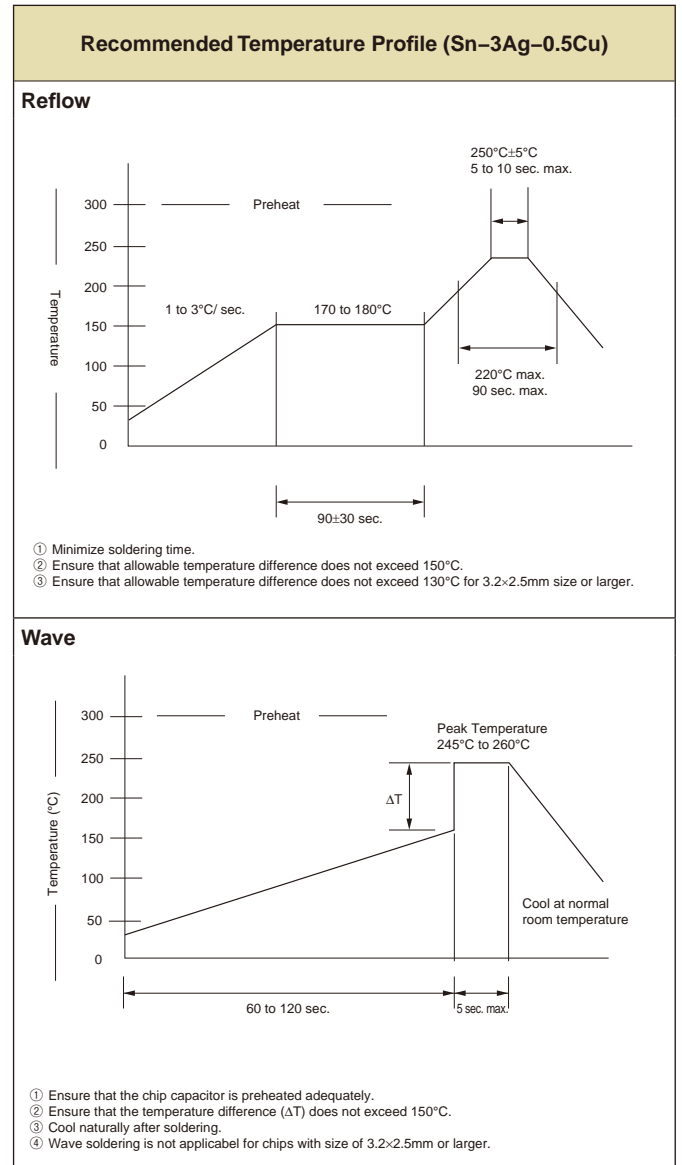
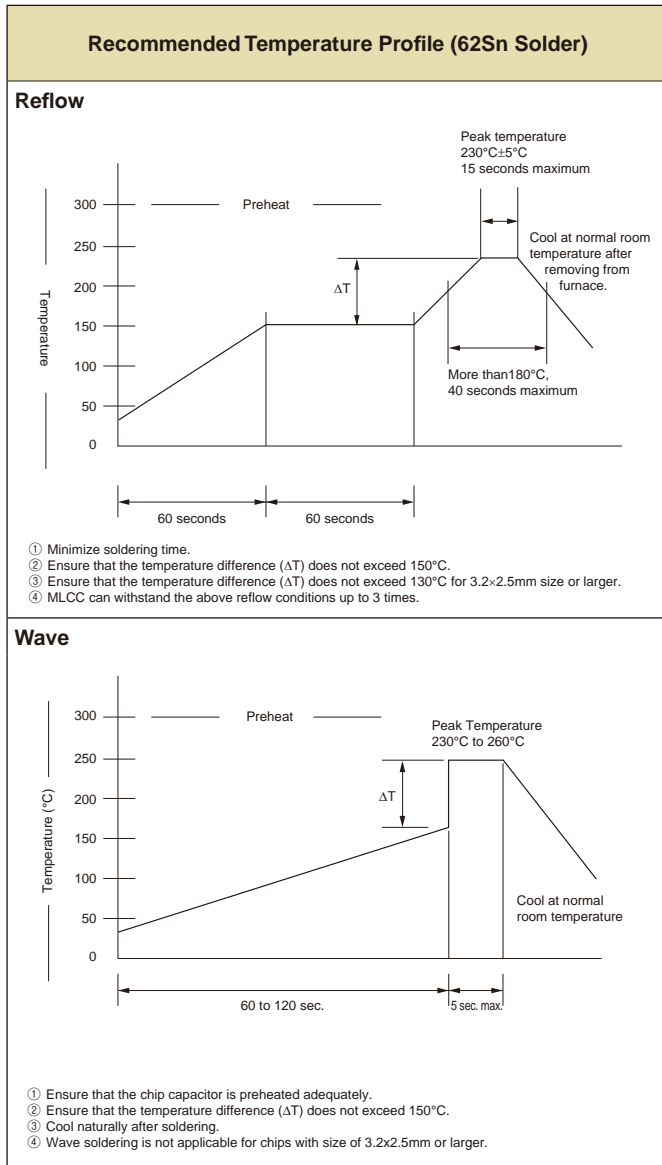

Sodering iron

- 1) Temperature of iron chip 380°C max.
- 2) Wattage 80W max.
- 3) Tip shape of soldering iron φ3.0mm max.
- 4) Soldering Time 3 sec. max.

5) Cautions

- a) Pre-heating is necessary rapid heating must be avoided.
 Delta T ≤ 150°C
- b) Avoid direct touching to capacitors.
- c) Avoid rapid cooling after soldering. Natural cooling is recommended.