

10 9 8 7 6 5 4 3 2 1

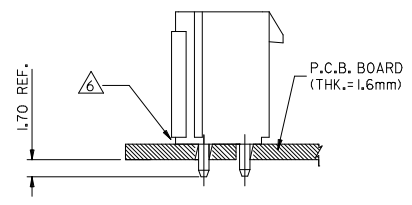
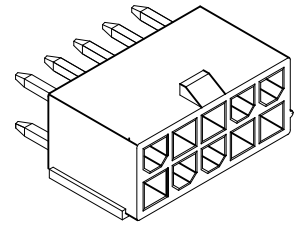
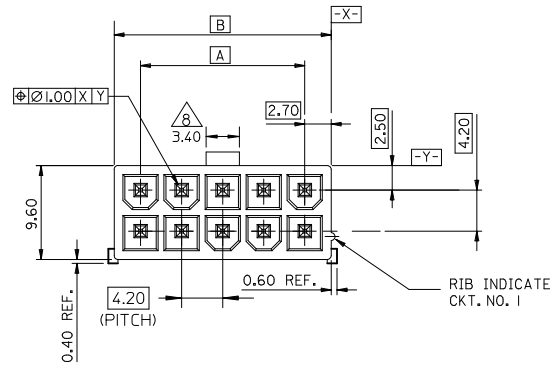

**RECOMMENDED INSTALLATION PATTERN**

51.60±0.55	46.20	24
47.40±0.55	42.00	22
43.20±0.50	37.80	20
39.00±0.45	33.60	18
34.80±0.35	29.40	16
30.60±0.30	25.20	14
26.40±0.30	21.00	12
22.20±0.30	16.80	10
18.00±0.30	12.60	8
13.80±0.25	8.40	6
9.60±0.25	4.20	4
5.40±0.20	--	2
B	A	CKT. SIZE

**NOTES**

- MATERIALS:  
- HEADER: NYLON 46, UL94V-0, COLOR SEE LEGEND.  
- PIN: BRASS
- FINISH- PLATING OF PIN:  
  - 2.2 TIN .00254 MIN. OVER NICKEL .00127 MIN.
  - 2.3 TIN .004-.010 OVER COPPER .002-.008.
  - 2.4 GOLD .00076 MIN. OVER NICKEL .00127 MIN.
  - 2.5 TIN .00254 MIN. OVER NICKEL .00127 MIN. WITH MATTE FINISH.
- PRODUCT SPECIFICATION: PS-87427-0001.
- PACKAGING SPECIFICATION :  
BULK PACK PER PK-87427-004.  
MATES WITH: MINI-FIT JR. RECEPTACLE SERIES 5557.
- HOUSING STANDOFF (0.70mm REF)
- THESE PARTS CONFORM TO CLASS 'B' REQUIREMENTS OF 'COSMETIC SPECIFICATION PS-45499-002.
- THIS DIMENSION IS 4.2 ON 2 CKT PARTS.

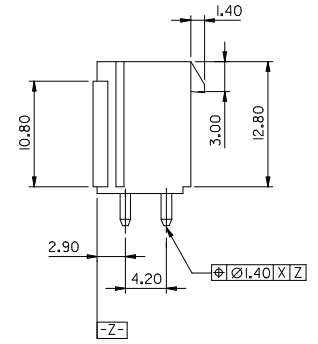
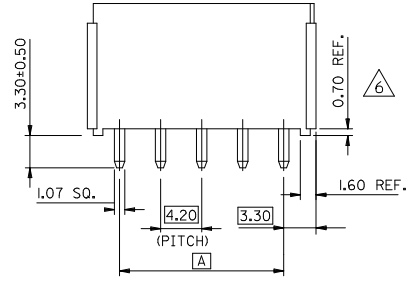

**LEGEND**

(REF TABLE ON SHEET 2)

- 36633-\*\*\*\* SEE TABLE 'X' ON SHEET 2 FOR CKT SIZE, PKG, PLATING, & HSG COLOR OPTIONS.
- 87427-\*\*\*\*
- CKT. SIZE
- PLATING OPTIONS
  - 2 = NOTE 2.2
  - 3 = NOTE 2.3
  - 8 = NOTE 2.4
- COLOR
  - 4 = BEIGE
  - 9 = BLACK

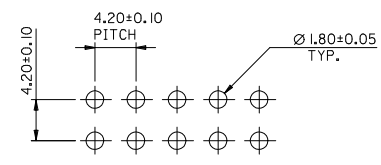

**RECOMMENDED P.C.B.LAYOUT**

ADD BLACK PN EC NO: UCP2010-3160 /DRWN: J JAGUILAR 2010/06/10 CHKD: JBELL 2010/06/10 APPR: FSMITH 2010/10/04	QUALITY SYMBOLS F7=0 F7=0 F7=0	GENERAL TOLERANCES (UNLESS SPECIFIED) mm INCH 4 PLACES ± --- ± --- 3 PLACES ± --- ± --- 2 PLACES ± 0.20 ± --- 1 PLACE ± --- ± --- ANGULAR ± ---°	DIMENSION STYLE MM ONLY DRAWN BY DATE SAM.C 960401 CHECKED BY DATE	SCALE 2:1 DESIGN UNITS METRIC THIRD ANGLE PROJECTION	
	MATERIAL NO. DRAFT WHERE APPLICABLE MUST REMAIN WITHIN DIMENSIONS	APPROVED BY DATE FSMITH 2010/10/04	TITLE 4.2MM W-T-B HIGH TEMP VERT. HEADER W/O FLANGES	MOLEX MOLEX INCORPORATED	SHEET NO. 1 OF 2
	REV D1	DESCRIPTION	DRAFT WHERE APPLICABLE MUST REMAIN WITHIN DIMENSIONS	SEE CHART	DOCUMENT NO. SD-87427-***4*
	THIS DRAWING CONTAINS INFORMATION THAT IS PROPRIETARY TO MOLEX INCORPORATED AND SHOULD NOT BE USED WITHOUT WRITTEN PERMISSION				

9 8 7 6 5 4 3 2 1

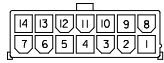

CKT. SIZE 14

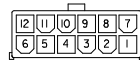

CKT. SIZE 12

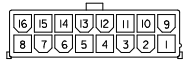

CKT. SIZE 16

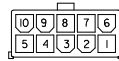

CKT. SIZE 10

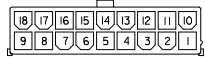

CKT. SIZE 18



CKT. SIZE 8

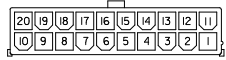

CKT. SIZE 20



CKT. SIZE 6



CKT. SIZE 22



CKT. SIZE 4

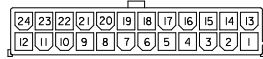

CKT. SIZE 24



CKT. SIZE 2

BEIGE		
	36633-0029	24
	36633-0028	22
	36633-0027	20
	36633-0039	18
	36633-0026	16
	36633-0038	14
	36633-0037	12
	36633-0025	10
	36633-0036	8
	36633-0035	6
	36633-0034	4
	36633-0033	2
PIN	ENG. NO.	CKT. SIZE
	BULK PACKED	

SEE NOTE 23 ON SHEET 1 FOR PLATING DETAILS

"#" CONSULT FACTORY FOR AVAILABILITY

BLACK		
#	87427-249*	24
#	87427-229*	22
#	87427-209*	20
#	87427-189*	18
#	87427-169*	16
#	87427-149*	14
#	87427-129*	12
#	87427-109*	10
#	87427-089*	8
#	87427-069*	6
#	87427-049*	4
#	87427-029*	2
	ENG. NO.	CKT. SIZE
	BULK PACKED	

BEIGE		
#	87427-244*	24
#	87427-224*	22
#	87427-204*	20
#	87427-184*	18
#	87427-164*	16
#	87427-144*	14
#	87427-124*	12
#	87427-104*	10
#	87427-084*	8
#	87427-064*	6
#	87427-044*	4
#	87427-024*	2
	ENG. NO.	CKT. SIZE
	BULK PACKED	

TABLE 'X'

ADD BLACK TABLE EC NO: UCP2010-3160 DRWN: J JAGUILAR 2010/06/10 CHKD: 2010/10/04 APPR: FSMITH 2010/10/04	QUALITY SYMBOLS ▽=0 ▽=0 ▽=0	GENERAL TOLERANCES (UNLESS SPECIFIED) mm INCH 4 PLACES ± --- ± --- 3 PLACES ± --- ± --- 2 PLACES ± 0.20 ± --- 1 PLACE ± --- ± --- ANGULAR ± ---°	DIMENSION STYLE MM ONLY DRAWN BY DATE SAM.C 960415 CHECKED BY DATE	SCALE 2:1 DESIGN UNITS METRIC THIRD ANGLE PROJECTION	TITLE 4.2MM W-T-B HIGH TEMP VERT. HEADER W/O FLANGES	
	DESCRIPTION D1	DRAFT WHERE APPLICABLE MUST REMAIN WITHIN DIMENSIONS	APPROVED BY DATE FSMITH 2010/10/04	MATERIAL NO. SEE CHART	MOLEX INCORPORATED DOCUMENT NO. SD-87427-***4*	SHEET NO. 2 OF 2
	THIS DRAWING CONTAINS INFORMATION THAT IS PROPRIETARY TO MOLEX INCORPORATED AND SHOULD NOT BE USED WITHOUT WRITTEN PERMISSION					
	SIZE B					