

TinyLogic HS Inverter

NC7S04

Description

The NC7S04 is a single high performance CMOS Inverter. Advanced Silicon Gate CMOS fabrication assures high speed and low power circuit operation over a broad V_{CC} range. ESD protection diodes inherently guard both input and output with respect to the V_{CC} and GND rails. Three stages of gain between input and output assures high noise immunity and reduced sensitivity to input edge rate.

Features

- Space-Saving SOT23-5, SC-74A and SC-88A 5-Lead Package
- Ultra-Small MicroPak™ Leadless Package
- High Speed: $t_{PD} = 3 \text{ ns Typ}$
- Low Quiescent Power: $I_{CC} < 1 \mu\text{A}$
- Balanced Output Drive: $2 \text{ mA } I_{OL}, -2 \text{ mA } I_{OH}$
- Broad V_{CC} Operating Range: $2 \text{ V} - 6 \text{ V}$
- Balanced Propagation Delays
- Specified for 3 V Operation
- These Devices are Pb-Free, Halogen Free/BFR Free and are RoHS Compliant

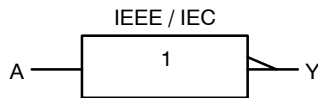
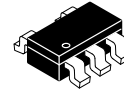
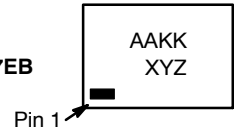

Figure 1. Logic Symbol

MARKING DIAGRAMS



SIP6
CASE 127EB



SC-74A
CASE 318BQ

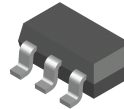
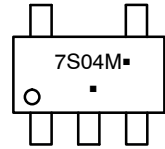

SOT23-5
CASE 527AH

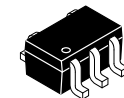
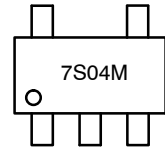

SC-88A
CASE 419A-02

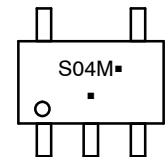

AA, 7S04, S04 = Specific Device Code
KK = 2-Digit Lot Run Traceability Code
XY = 2-Digit Date Code Format
Z = Assembly Plant Code
M = Date Code*

*Date Code orientation and/or position may vary depending upon manufacturing location.

ORDERING INFORMATION

See detailed ordering, marking and shipping information in the package dimensions section on page 5 of this data sheet.

NOTE: Some of the devices on this data sheet have been **DISCONTINUED**. Please refer to the table on page 5.

NC7S04

Pin Configurations

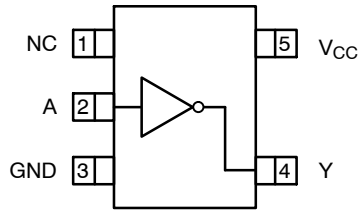

Figure 2. SOT23-5, SC-88A and SC-74A (Top View)

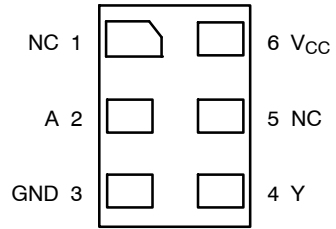

Figure 3. MicroPak (Top Through View)

PIN DESCRIPTIONS

Name	Description
A	Input
Y	Output
NC	No Connect

FUNCTION TABLE ($Y = \bar{A}$)

Input	Output
A	Y
L	H
H	L

H = HIGH Logic Level
L = LOW Logic Level

NC7S04

ABSOLUTE MAXIMUM RATINGS

Symbol	Parameter	Min	Max	Unit	
V_{CC}	Supply Voltage	-0.5	6.5	V	
I_{IK}	DC Input Diode Current	$V_{IN} < 0\text{ V}$	-	-20	mA
		$V_{IN} > V_{CC}$	-	+20	
V_{IN}	DC Input Voltage	-0.5	$V_{CC} + 0.5$	V	
I_{OK}	DC Output Diode Current	$V_{OUT} < 0\text{ V}$	-	-20	mA
		$V_{OUT} > V_{CC}$	-	+20	
V_{OUT}	DC Output Voltage	-0.5	$V_{CC} + 0.5$	V	
I_{OUT}	DC Output Source or Sink Current	-	± 12.5	mA	
I_{CC} or I_{GND}	DC V_{CC} or Ground Current per Output Pin	-	± 25	mA	
T_{STG}	Storage Temperature	-65	+150	$^{\circ}\text{C}$	
T_J	Junction Temperature	-	+150	$^{\circ}\text{C}$	
T_L	Lead Temperature (Soldering, 10 Seconds)	-	+260	$^{\circ}\text{C}$	
P_D	Power Dissipation in Still Air	SC-74A / SOT23-5	-	390	mW
		SC-88A	-	332	
		MicroPak-6	-	812	

Stresses exceeding those listed in the Maximum Ratings table may damage the device. If any of these limits are exceeded, device functionality should not be assumed, damage may occur and reliability may be affected.

RECOMMENDED OPERATING CONDITIONS

Symbol	Parameter	Conditions	Min	Max	Unit
V_{CC}	Supply Voltage		2.0	6.0	V
V_{IN}	Input Voltage		0	V_{CC}	V
V_{OUT}	Output Voltage		0	V_{CC}	V
T_A	Operating Temperature		-40	+85	$^{\circ}\text{C}$
t_r, t_f	Input Rise and Fall Times	V_{CC} at 2.0 V	0	20	ns/V
		V_{CC} at 3.0 V	0	20	
		V_{CC} at 4.5 V	0	10	
		V_{CC} at 6.0 V	0	5	
θ_{JA}	Thermal Resistance	SC-74A / SOT23-5	-	320	$^{\circ}\text{C}/\text{W}$
		SC-88A	-	377	
		MicroPak-6	-	154	

Functional operation above the stresses listed in the Recommended Operating Ranges is not implied. Extended exposure to stresses beyond the Recommended Operating Ranges limits may affect device reliability.

1. Unused inputs must be held HIGH or LOW. They may not float.

NC7S04

DC ELECTRICAL CHARACTERISTICS

Symbol	Parameter	V _{CC} (V)	Conditions	T _A = +25°C			T _A = -40 to +85°C		Unit
				Min	Typ	Max	Min	Max	
V _{IH}	HIGH Level Input Voltage	2.0 3.0 – 6.0		1.50 0.7 V _{CC}	– –	– –	1.50 0.7 V _{CC}	– –	V
V _{IL}	LOW Level Input Voltage	2.0 3.0 – 6.0		– –	– –	0.50 0.3 V _{CC}	– –	0.50 0.3 V _{CC}	V
V _{OH}	HIGH Level Output Voltage	2.0 3.0 4.5 6.0	I _{OH} = –20 μA V _{IN} = V _{IH} or V _{IL}	1.90 2.90 4.40 5.90	2.0 3.0 4.5 6.0	– – – –	1.90 2.90 4.40 5.90	– – – –	V
		3.0 4.5 6.0	V _{IN} = V _{IH} or V _{IL} I _{OH} = –1.3 mA I _{OH} = –2.0 mA I _{OH} = –2.6 mA	2.68 4.18 5.68	2.85 4.35 5.85	– – –	2.63 4.13 5.63	– – –	V
V _{OL}	LOW Level Output Voltage	2.0 3.0 4.5 6.0	I _{OL} = 20 μA V _{IN} = V _{IH} or V _{IL}	– – – –	0.0 0.0 0.0 0.0	0.10 0.10 0.10 0.10	– – – –	0.10 0.10 0.10 0.10	V
		3.0 4.5 6.0	V _{IN} = V _{IH} or V _{IL} I _{OL} = 1.3 mA I _{OL} = 2.0 mA I _{OL} = 2.6 mA	– – –	0.1 0.1 0.1	0.26 0.26 0.26	– – –	0.33 0.33 0.33	V
I _{IN}	Input Leakage Current	6.0	V _{IN} = V _{CC} , GND	–	–	±0.1	–	±1.0	μA
I _{CC}	Quiescent Supply Current	6.0	V _{IN} = V _{CC} , GND	–	–	1.0	–	10.0	μA

AC ELECTRICAL CHARACTERISTICS

Symbol	Parameter	V _{CC} (V)	Conditions	T _A = +25°C			T _A = -40 to +85°C		Unit
				Min	Typ	Max	Min	Max	
t _{PLH} , t _{PHL}	Propagation Delay (Figure 4, 6)	5.0	C _L = 15 pF	–	3.0	15.0	–	–	ns
		2.0 3.0 4.5 6.0	C _L = 50 pF	– – – –	18.0 10.0 7.0 6.0	100.0 27.0 20.0 17.0	– – – –	125.0 35.0 25.0 21.0	ns
		5.0	C _L = 15 pF	–	3.0	10.0	–	–	ns
		2.0 3.0 4.5 6.0	C _L = 50 pF	– – – –	25.0 16.0 11.0 9.0	125.0 35.0 25.0 21.0	– – – –	155.0 45.0 31.0 26.0	ns
C _{IN}	Input Capacitance (Figure 4, 6)	Open		–	2.0	10.0	–	10.0	pF
C _{PD}	Power Dissipation Capacitance (Figure 5)	5.0	(Note 2)	–	6.0	–	–	–	pF

2. C_{PD} is defined as the value of the internal equivalent capacitance which is derived from dynamic operating current consumption (I_{CCD}) at no output loading and operating at 50% duty cycle. C_{PD} is related to I_{CCD} dynamic operating current by the expression:
 $I_{CCD} = (C_{PD})(V_{CC})(f_{IN}) + (I_{CCstatic})$.

AC Loading and Waveforms

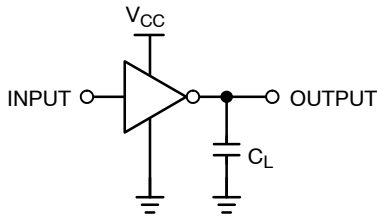

C_L includes load and stray capacitance
 Input PRR = 1.0 MHz, t_w = 500 ns

Figure 4. AC Test Circuit

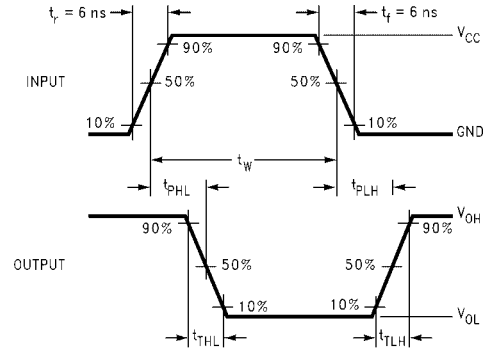
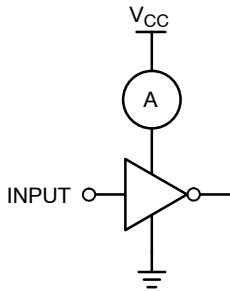

Figure 6. AC Waveforms



Input = AC Waveforms;
 PRR = Variable; Duty Cycle = 50%.

Figure 5. I_{CCD} Test Circuit

DEVICE ORDERING INFORMATION

Device	Top Mark	Packages	Shipping [†]
NC7S04M5X	7S04	SC-74A	3000 / Tape & Reel
NC7S04P5X	S04	SC-88A	3000 / Tape & Reel
NC7S04L6X	AA	SIP6, MicroPak	5000 / Tape & Reel

DISCONTINUED (Note 3)

NC7S04M5X-L22090	7S04	SOT23-5	3000 / Tape & Reel
NC7S04P5X-L22057	S04	SC-88A	3000 / Tape & Reel
NC7S04L6X-L22175	AA	SIP6, MicroPak	5000 / Tape & Reel

[†]For information on tape and reel specifications, including part orientation and tape sizes, please refer to our Tape and Reel Packaging Specifications Brochure, BRD8011/D.

3. **DISCONTINUED:** These devices are not recommended for new design. Please contact your onsemi representative for information. The most current information on these devices may be available on www.onsemi.com.

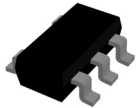

SC-74A-5 3.00x1.50x0.95, 0.95P
CASE 318BQ
ISSUE C

DATE 26 FEB 2024

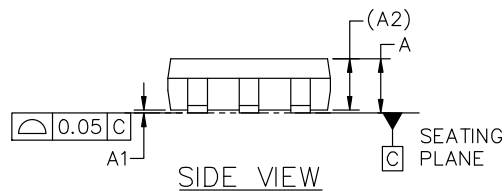
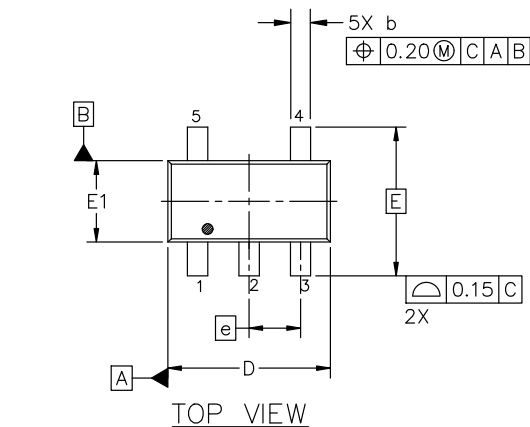

NOTES:

1. DIMENSIONING AND TOLERANCING CONFORM TO ASME Y14.5-2018.
2. ALL DIMENSION ARE IN MILLIMETERS (ANGLES IN DEGREES).
3. MAXIMUM LEAD THICKNESS INCLUDES LEAD FINISH THICKNESS. MINIMUM LEAD THICKNESS IS THE MINIMUM THICKNESS OF BASE MATERIAL.
4. DIMENSIONS D AND E1 DO NOT INCLUDE MOLD FLASH, PROTRUSIONS OF GATE BURRS. MOLD FLASH, PROTRUSIONS, OR GATE BURRS SHALL NOT EXCEED 0.15 PER SIDE.

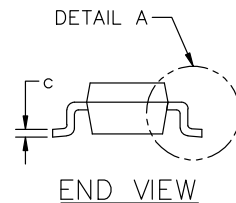

DIM	MILLIMETERS		
	MIN.	NOM.	MAX.
A	0.90	1.00	1.10
A1	0.01	0.18	0.10
A2	0.95 REF.		
b	0.25	0.37	0.50
c	0.10	0.18	0.26
D	2.85	3.00	3.15
E	2.75 BSC		
E1	1.35	1.50	1.65
e	0.95 BSC		
L	0.20	0.40	0.60
L1	0.62 REF.		
L2	0.25 BSC		
θ	0°	5°	10°

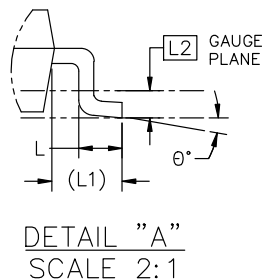

GENERIC MARKING DIAGRAM*

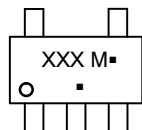

- XXX = Specific Device Code
- M = Date Code
- = Pb-Free Package

(Note: Microdot may be in either location)

*This information is generic. Please refer to device data sheet for actual part marking. Pb-Free indicator, "G" or microdot "▪", may or may not be present. Some products may not follow the Generic Marking.

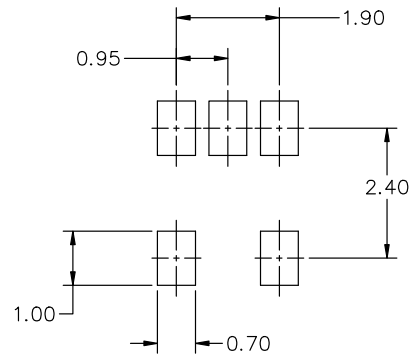

RECOMMENDED MOUNTING FOOTPRINT*

* FOR ADDITIONAL INFORMATION ON OUR Pb-FREE STRATEGY AND SOLDERING DETAILS, PLEASE DOWNLOAD THE ON SEMICONDUCTOR SOLDERING AND MOUNTING TECHNIQUES REFERENCE MANUAL, SOLDERRM/D.

DOCUMENT NUMBER:	98AON66279G	Electronic versions are uncontrolled except when accessed directly from the Document Repository. Printed versions are uncontrolled except when stamped "CONTROLLED COPY" in red.
DESCRIPTION:	SC-74A-5 3.00x1.50x0.95, 0.95P	PAGE 1 OF 1

onsemi and ONSEMI are trademarks of Semiconductor Components Industries, LLC dba onsemi or its subsidiaries in the United States and/or other countries. onsemi reserves the right to make changes without further notice to any products herein. onsemi makes no warranty, representation or guarantee regarding the suitability of its products for any particular purpose, nor does onsemi assume any liability arising out of the application or use of any product or circuit, and specifically disclaims any and all liability, including without limitation special, consequential or incidental damages. onsemi does not convey any license under its patent rights nor the rights of others.



SCALE 2:1

SC-88A (SC-70-5/SOT-353)
CASE 419A-02
ISSUE M

DATE 11 APR 2023



RECOMMENDED MOUNTING FOOTPRINT

* For additional information on our Pb-Free strategy and soldering details, please download the ON Semiconductor Soldering and Mounting Techniques Reference Manual, SOLDERM/D.

NOTES:

1. DIMENSIONING AND TOLERANCING PER ANSI Y14.5M, 1982.
2. CONTROLLING DIMENSION: MILLIMETERS
3. 419A-01 OBSOLETE. NEW STANDARD 419A-02
4. DIMENSIONS D AND E1 DO NOT INCLUDE MOLD FLASH, PROTRUSIONS, OR GATE BURRS. MOLD FLASH, PROTRUSIONS, OR GATE BURRS SHALL NOT EXCEED 0.1016MM PER SIDE.

DIM	MILLIMETERS		
	MIN.	NOM.	MAX.
A	0.80	0.95	1.10
A1	---	---	0.10
A3	0.20 REF		
b	0.10	0.20	0.30
c	0.10	---	0.25
D	1.80	2.00	2.20
E	2.00	2.10	2.20
E1	1.15	1.25	1.35
e	0.65 BSC		
L	0.10	0.15	0.30

GENERIC MARKING DIAGRAM*

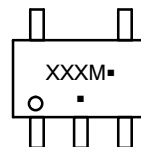

*This information is generic. Please refer to device data sheet for actual part marking. Pb-Free indicator, "G" or microdot "▪", may or may not be present. Some products may not follow the Generic Marking.

XXX = Specific Device Code
M = Date Code
▪ = Pb-Free Package

(Note: Microdot may be in either location)

STYLE 1:

- PIN 1. BASE
- EMITTER
- BASE
- COLLECTOR
- COLLECTOR

STYLE 2:

- PIN 1. ANODE
- EMITTER
- BASE
- COLLECTOR
- CATHODE

STYLE 3:

- PIN 1. ANODE 1
- N/C
- ANODE 2
- CATHODE 2
- CATHODE 1

STYLE 4:

- PIN 1. SOURCE 1
- DRAIN 1/2
- SOURCE 1
- GATE 1
- GATE 2

STYLE 5:

- PIN 1. CATHODE
- COMMON ANODE
- CATHODE 2
- CATHODE 3
- CATHODE 4

STYLE 6:

- PIN 1. EMITTER 2
- BASE 2
- EMITTER 1
- COLLECTOR
- COLLECTOR 2/BASE 1

STYLE 7:

- PIN 1. BASE
- EMITTER
- BASE
- COLLECTOR
- COLLECTOR

STYLE 8:

- PIN 1. CATHODE
- COLLECTOR
- N/C
- BASE
- EMITTER

STYLE 9:

- PIN 1. ANODE
- CATHODE
- ANODE
- ANODE
- ANODE

Note: Please refer to datasheet for style callout. If style type is not called out in the datasheet refer to the device datasheet pinout or pin assignment.

DOCUMENT NUMBER:	98ASB42984B	Electronic versions are uncontrolled except when accessed directly from the Document Repository. Printed versions are uncontrolled except when stamped "CONTROLLED COPY" in red.
DESCRIPTION:	SC-88A (SC-70-5/SOT-353)	PAGE 1 OF 1

onsemi and onsemi are trademarks of Semiconductor Components Industries, LLC dba onsemi or its subsidiaries in the United States and/or other countries. onsemi reserves the right to make changes without further notice to any products herein. onsemi makes no warranty, representation or guarantee regarding the suitability of its products for any particular purpose, nor does onsemi assume any liability arising out of the application or use of any product or circuit, and specifically disclaims any and all liability, including without limitation special, consequential or incidental damages. onsemi does not convey any license under its patent rights nor the rights of others.

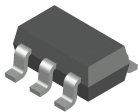

**SOT-23, 5 Lead
CASE 527AH
ISSUE A**

DATE 09 JUN 2021

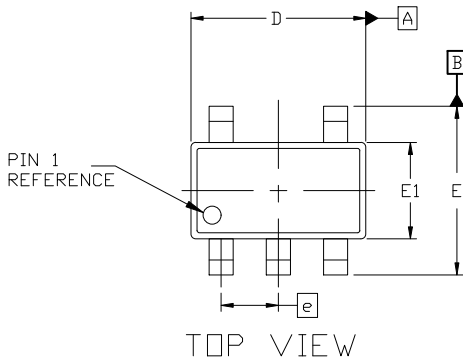

NOTES:

1. DIMENSIONING AND TOLERANCING PER ASME Y14.5M, 19894
2. CONTROLLING DIMENSION: MILLIMETERS
3. MAXIMUM LEAD THICKNESS INCLUDES LEAD FINISH THICKNESS. MINIMUM LEAD THICKNESS IS THE MINIMUM THICKNESS OF THE BASE MATERIAL.
4. DIMENSIONS D AND E1 DO NOT INCLUDE MOLD FLASH, PROTRUSIONS, OR GATE BURRS. MOLD FLASH, PROTRUSIONS, OR GATE BURRS SHALL NOT EXCEED 0.25 PER SIDE. D AND E1 DIMENSIONS ARE DETERMINED AT DATUM D.
5. DIMENSION 'b' DOES NOT INCLUDE DAMBAR PROTRUSION. ALLOWABLE DAMBAR PROTRUSION SHALL BE 0.08mm TOTAL IN EXCESS OF THE 'b' DIMENSION AT MAXIMUM MATERIAL CONDITION. MINIMUM SPACE BETWEEN PROTRUSION AND AN ADJACENT LEAD SHALL NOT BE LESS THAN 0.07mm.

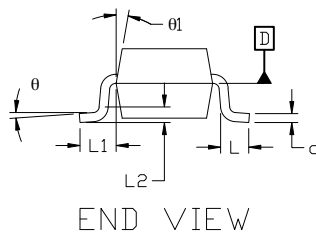
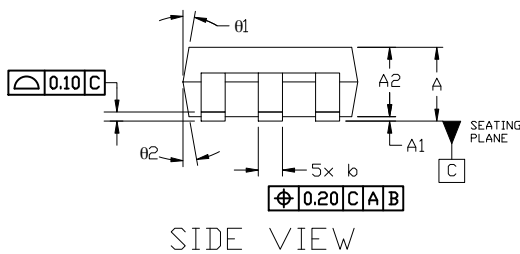

DIM	MILLIMETERS		
	MIN.	NOM.	MAX.
A	0.90	—	1.45
A1	0.00	—	0.15
A2	0.90	1.15	1.30
b	0.30	—	0.50
c	0.08	—	0.22
D	2.90 BSC		
E	2.80 BSC		
E1	1.60 BSC		
e	0.95 BSC		
L	0.30	0.45	0.60
L1	0.60 REF		
L2	0.25 REF		
theta	0°	4°	8°
theta1	0°	10°	15°
theta2	0°	10°	15°

GENERIC MARKING DIAGRAM*

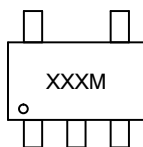

XXX = Specific Device Code
M = Date Code

*This information is generic. Please refer to device data sheet for actual part marking. Pb-Free indicator, "G" or microdot "•", may or may not be present. Some products may not follow the Generic Marking.

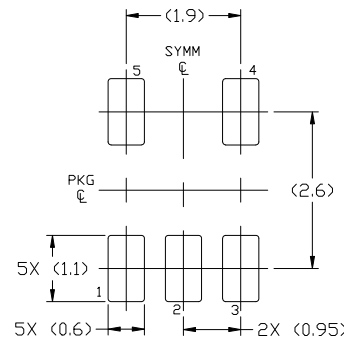

RECOMMENDED MOUNTING FOOTPRINT

For additional information on our Pb-Free strategy and soldering details, please download the DN Semiconductor Soldering and Mounting Techniques Reference Manual, SOLDERRM/D.

DOCUMENT NUMBER:	98AON34320E	Electronic versions are uncontrolled except when accessed directly from the Document Repository. Printed versions are uncontrolled except when stamped "CONTROLLED COPY" in red.
DESCRIPTION:	SOT-23, 5 LEAD	PAGE 1 OF 1

onsemi and ONSEMI are trademarks of Semiconductor Components Industries, LLC dba onsemi or its subsidiaries in the United States and/or other countries. onsemi reserves the right to make changes without further notice to any products herein. onsemi makes no warranty, representation or guarantee regarding the suitability of its products for any particular purpose, nor does onsemi assume any liability arising out of the application or use of any product or circuit, and specifically disclaims any and all liability, including without limitation special, consequential or incidental damages. onsemi does not convey any license under its patent rights nor the rights of others.

onsemi, **Onsemi**, and other names, marks, and brands are registered and/or common law trademarks of Semiconductor Components Industries, LLC dba "**onsemi**" or its affiliates and/or subsidiaries in the United States and/or other countries. **onsemi** owns the rights to a number of patents, trademarks, copyrights, trade secrets, and other intellectual property. A listing of **onsemi**'s product/patent coverage may be accessed at www.onsemi.com/site/pdf/Patent-Marking.pdf. **onsemi** reserves the right to make changes at any time to any products or information herein, without notice. The information herein is provided "as-is" and **onsemi** makes no warranty, representation or guarantee regarding the accuracy of the information, product features, availability, functionality, or suitability of its products for any particular purpose, nor does **onsemi** assume any liability arising out of the application or use of any product or circuit, and specifically disclaims any and all liability, including without limitation special, consequential or incidental damages. Buyer is responsible for its products and applications using **onsemi** products, including compliance with all laws, regulations and safety requirements or standards, regardless of any support or applications information provided by **onsemi**. "Typical" parameters which may be provided in **onsemi** data sheets and/or specifications can and do vary in different applications and actual performance may vary over time. All operating parameters, including "Typicals" must be validated for each customer application by customer's technical experts. **onsemi** does not convey any license under any of its intellectual property rights nor the rights of others. **onsemi** products are not designed, intended, or authorized for use as a critical component in life support systems or any FDA Class 3 medical devices or medical devices with a same or similar classification in a foreign jurisdiction or any devices intended for implantation in the human body. Should Buyer purchase or use **onsemi** products for any such unintended or unauthorized application, Buyer shall indemnify and hold **onsemi** and its officers, employees, subsidiaries, affiliates, and distributors harmless against all claims, costs, damages, and expenses, and reasonable attorney fees arising out of, directly or indirectly, any claim of personal injury or death associated with such unintended or unauthorized use, even if such claim alleges that **onsemi** was negligent regarding the design or manufacture of the part. **onsemi** is an Equal Opportunity/Affirmative Action Employer. This literature is subject to all applicable copyright laws and is not for resale in any manner.

ADDITIONAL INFORMATION

TECHNICAL PUBLICATIONS:

Technical Library: www.onsemi.com/design/resources/technical-documentation
onsemi Website: www.onsemi.com

ONLINE SUPPORT: www.onsemi.com/support

For additional information, please contact your local Sales Representative at www.onsemi.com/support/sales