

SMD Choke Coils

Singapore

Series: **H**

Type: **ELL6□H**

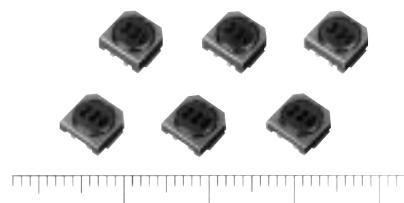

Type ELL6□H

SMD type choke coils (2.5 mm, 3.0 mm)

■ Features

- Thin type (height 2.5 mm, 3.0 mm)
- Higher reliability in mounting by separated user terminal and internal connection.
- Capable of corresponding big current

■ Recommended Applications

- Videos, Audio, Mobile communications, Electric battery driving equipment
- Choke coils for Chopper circuit decoupling choked in DC/DC convertor circuit

■ Cautions for Use

Convertor electric power of DC/DC convertor

- Chopper type : 1 W max.
- Operating temperature
- 105 °C max. (Including self-temperature rise)

■ Standard Packing Quantity

- 1000 pcs./Reel

■ Explanation of Part Numbers

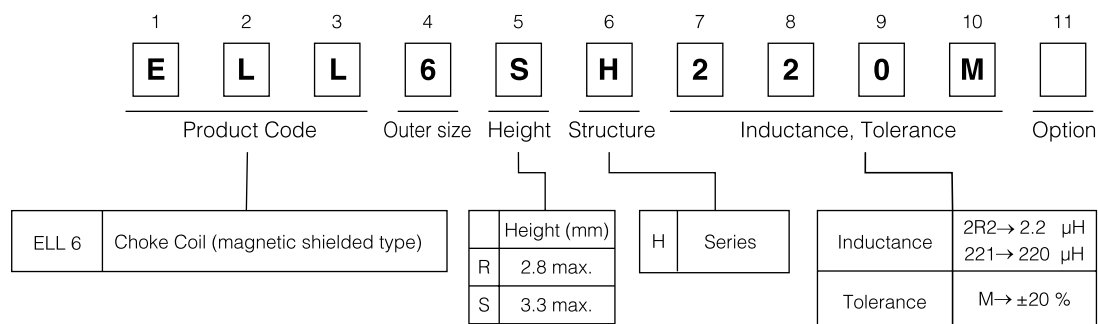

■ Dimensions in mm (not to scale)

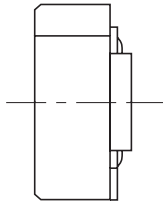
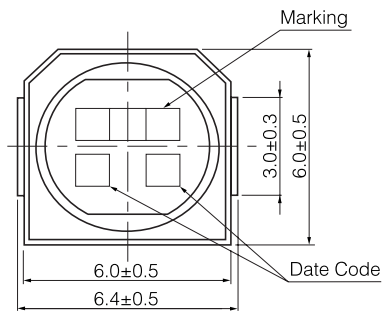

■ Connections (Top view)

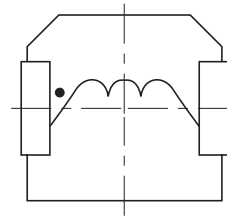

■ Recommended Land Pattern in mm (not to scale)

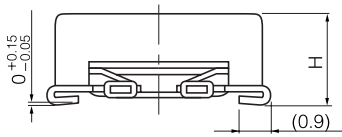

Type	Height
ELL6RH	2.5 mm±0.3 mm
ELL6SH	3.0 mm±0.3 mm

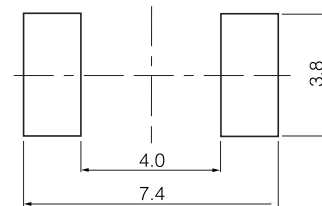

■ Examples

Part No.	Inductance (μH) at 100 kHz Tol. ±20%	DCR (mΩ) at 20 °C Tol. ±20%		* Current mA (max.)		Marking
		6 RH	6 SH	6 RH	6 SH	
ELL6□H1R0M	1.0	19	19	3000	3400	1R0
ELL6□H1R5M	1.5	24	24	2400	3200	1R5
ELL6□H2R7M	2.7	39	31	1800	2400	2R7
ELL6□H3R3M	3.3	44	34	1600	2200	3R3
ELL6□H4R7M	4.7	49	42	1580	2000	4R7
ELL6□H5R1M	5.1	56	—	1550	—	5R1
ELL6□H5R6M	5.6	—	49	—	1800	5R6
ELL6□H6R2M	6.2	62	—	1400	—	6R2
ELL6□H6R8M	6.8	—	52	—	1500	6R8
ELL6□H7R5M	7.5	80	—	1250	—	7R5
ELL6□H8R2M	8.2	87	61	1200	1400	8R2
ELL6□H100M	10.0	95	65	1100	1300	100
ELL6□H120M	12.0	130	71	1000	1200	120
ELL6□H150M	15.0	150	96	850	1100	150
ELL6□H180M	18.0	170	110	800	1000	180
ELL6□H220M	22.0	220	140	700	900	220
ELL6□H270M	27.0	260	160	650	800	270
ELL6□H330M	33.0	380	180	600	700	330
ELL6□H390M	39.0	410	240	550	650	390
ELL6□H470M	47.0	480	270	500	600	470
ELL6□H560M	56.0	540	290	450	550	560
ELL6□H680M	68.0	770	520	400	500	680
ELL6□H820M	82.0	870	600	350	450	820
ELL6□H101M	100.0	1000	680	300	400	101
ELL6□H121M	120.0	1500	750	280	370	121
ELL6□H151M	150.0	1800	860	250	350	151
ELL6□H181M	180.0	2000	1200	230	300	181

Current: This indicates the value of current when the inductance is 80% more than nominal value and temperature rising Δt=45 °C lower at D.C superposition. (at 20 °C)