

- Standard Voltage to 250 V AC/400 V DC, 3 A
- Cable Assemblies
- Cable Connectors & Connector Blocks
- Breakouts & PCB Connectors
- Guaranteed Compatibility



Simple Connection

Pickering connection solutions provide a simple way of connecting to a user's device under test or remote connection. The products include cable assemblies, cable connectors, connector blocks, breakouts and pcb connectors.

Cable Assemblies

Cable assemblies are offered in connector to connector, and connector to unterminated versions. There are 3 termination options for the unterminated cables - ferrules, tinned copper or simple cut end.

Connector Blocks and Breakouts

Connector Blocks convert the 78-pin D-type connections to an array of screw terminals. The customer can then interface to other devices using his own wiring. An alternative is a remote Breakout with screw terminals at the end of a cable assembly.



Examples of Pickering PXI and LXI Products using 78-Pin D-type Connectors



Custom Design Needs

Pickering Interfaces can manufacture custom connector accessories to suit any application. If you do not see what you need in this data sheet contact your Pickering Interfaces sales office with information on your requirements or consider using our free online Cable Design Tool.

Using our Cable Design Tool, you can graphically design your own custom cable assembly. Once completed and submitted, our engineers will generate a quote for your cable requirements. See pickeringtest.com/cdt





Cable Assemblies

Description		End 1	End 2		Cable Length	Product Order Code and Part Number	Data Sheet Page
		Gender & Cable Exit	Gender & Cable Exit	Options			
	Cable Assy, 78-Pin D-Type, 3A	Male, 45° Towards Pin 1	Female, 45° Away from Pin 1	-	0.5 m 1 m 2 m	40-970-078-0.5m-MF 40-970-078-1m-MF 40-970-078-2m-MF	5
		Female, 45° Away from Pin 1	Female, 45° Away from Pin 1	-	0.5 m 1 m 2 m	40-970-078-0.5m-FF 40-970-078-1m-FF 40-970-078-2m-FF	6
	Cable Assy, 78-Pin D-Type to Underterminated, 3A	Female, 45° Away from Pin 1	NA	Ferrules	0.5 m 1 m 2 m	40-972-078-0.5m-FU 40-972-078-1m-FU 40-972-078-2m-FU	7
				Tinned End	0.5 m 1 m 2 m	A078HF4-T-0A050 A078HF4-T-0A100 A078HF4-T-0A200	
				Cut End	0.5 m 1 m 2 m	A078HF4-C-0A050 A078HF4-C-0A100 A078HF4-C-0A200	
		Female, 45° Towards Pin 1	NA	Ferrules	0.5 m 1 m 2 m	A078HF5-F-0A050 A078HF5-F-0A100 A078HF5-F-0A200	8
				Tinned End	0.5 m 1 m 2 m	A078HF5-T-0A050 A078HF5-T-0A100 A078HF5-T-0A200	
				Cut End	0.5 m 1 m 2 m	A078HF5-C-0A050 A078HF5-C-0A100 A078HF5-C-0A200	

Note: Custom lengths by quotation. Max length 5 m.





Specific Function Cable Assemblies

Description		End 1	End 2		Cable Length	Product Order Code and Part Number	Data Sheet Page
		Gender & Cable Exit	Gender & Cable Exit	Options			
	Cable Assy, 78-Pin D-Type to Mini Thermocouple Plugs	Male, 45° Away from Pin 1	Male, Rear Cable Exit	32 Plugs 24 Plugs 16 Plugs 8 Plugs	1 m	A078DFR-32M002T5A100 A078DFR-24M002T5A100 A078DFR-16M002T5A100 A078DFR-08M002T5A100	9
	Cable Assy, 78-Pin D-Type to 2 x 4 mm DMM Bayonet Plug	Female, 45° Away from Pin	NA	-	1 m	40-975-078-1m	10



Note: Custom lengths by quotation.

Please click on the page number to navigate to the data sheet page required. Return to this page via the **C** button.

Female Connector Blocks/Connectors

Description		Gender & Cable Exit	Type	Product Order Code and Part Number	Page
	Shielded Connector Block, 78-Pin D-Type, 2 A, Screw Terminal	Female, Rear	With Backshell	40-965A-078-F	11
			Without Backshell	92-965-078-F	
	Breakout with DIN Rail Mount, 78-Pin D-Type, 2 A, Screw Terminal	Female	DIN Rail Mount	40-967-078-F	12
	Cable Connector 78-Pin D-Type, 3 A, Solder Bucket	Female, 45° Options	With Backshell	40-960-078-F	13
			Without Backshell	92-960-078-F	
	PCB Connector 78-Pin D-Type, 3 A	Female	Right Angle PCB Mount	40-963-078-RF	14
			Straight PCB Mount	40-963-078-SF	15



Male Breakouts/PCB Connectors

Description		Gender & Cable Exit	Type	Product Order Code and Part Number	Page
	Breakout with DIN Rail Mount, 78-Pin D-Type, 2 A, Screw Terminal	Male	DIN Rail Mount	40-967-078-M	16
	PCB Connector 78-Pin D-Type, 3 A	Male	Right Angle PCB Mount	40-963-078-RM	17
			Straight PCB Mount	40-963-078-SM	18

Additional Accessories

Although the items below do not directly mate with Pickering Interfaces products, customers may find them useful in the development of their own connection solutions.

Cable Assemblies

Description		End 1	End 2		Cable Length	Product Order Code and Part Number	Data Sheet Page
		Gender & Cable Exit	Gender & Cable Exit	Options			
	Cable Assy, 78-Pin D-Type, 3 A	Male, 45° Towards Pin 1	Male, 45° Towards Pin 1	-	0.5 m 1 m 2 m	40-970-078-0.5m-MM 40-970-078-1m-MM 40-970-078-2m-MM	20
	Cable Assy, 78-Pin D-Type to Unterminated, 3 A	Male, 45° Towards Pin 1	NA	Ferrules	0.5 m 1 m 2 m	40-972-078-0.5m-MU 40-972-078-1m-MU 40-972-078-2m-MU	21
				Tinned End	0.5 m 1 m 2 m	A078HM5-T-0A050 A078HM5-T-0A100 A078HM5-T-0A200	
				Cut End	0.5 m 1 m 2 m	A078HM5-C-0A050 A078HM5-C-0A100 A078HM5-C-0A200	

Note: Custom lengths by quotation. Max length 5 m.

Male Connector Blocks/PCB Connectors

Description	Gender & Cable Exit	Type	Product Order Code and Part Number	Page
	Male, 45° Options	With Backshell	40-960-078-M	22
		Without Backshell	92-960-078-M	

Cable Management

Rack Mount Cable Management Kit..... 23

Custom Termination

Customization Possibilities 24

- High Specification Cable
- Highly Flexible Cable with Braided Sleeving
- Fully Screened Cable Construction with Strain Relief
- 45° Cable Exit

Technical Specification

Connector Type (End A):	78-Pin D-Subminiature, Density and a half
Gender	Female
Securing Method	4-40 UNC screwlocks, male
Connector Type (End B):	78-Pin D-Subminiature, Density and a half
Gender	Male
Securing Method	4-40 UNC screwlocks, male
Maximum Current	3 A
Maximum Voltage	250 VAC/400 VDC
Insulation Resistance	1000 MOhm
Connectors:	
Contact Material	Gold plated copper alloy
Contact Resistance	20 mOhm
Cable Exit:	
Female Connectors	45° (Away from Pin 1)
Male Connectors	45° (Towards Pin 1)
Overall Size (Approx)	H68 x W18.5 x D55 mm
Cable Type:	Individual wires, screened & sleeved
Conductor: Material	Silver plated copper wire
Strands	7/0.15 (0.124 mm ² , 26AWG)
Resistance	0.137 Ω/m
Insulation	PFA
Outer Sleeve	Polyester
Screened Construction	Yes (Cable screen connected to backshells)
Additional Braided Sleeve	Yes
Cable O/D	12 mm
Minimum Bend Radius	25 mm
Door Closure Allowance	55 mm (see diagram)

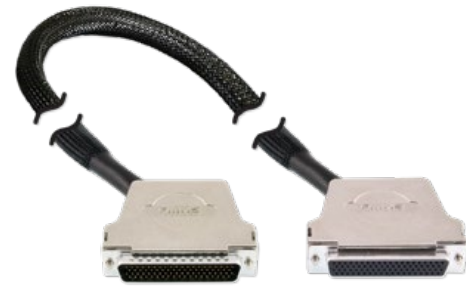

78-Pin D-Type Cable Assembly

Product Compatibility

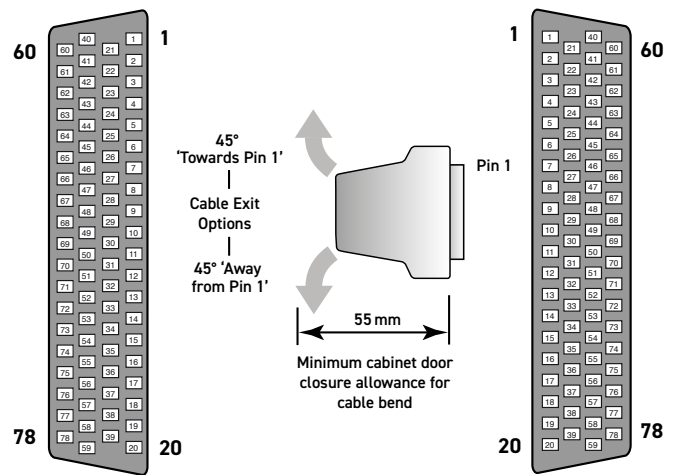
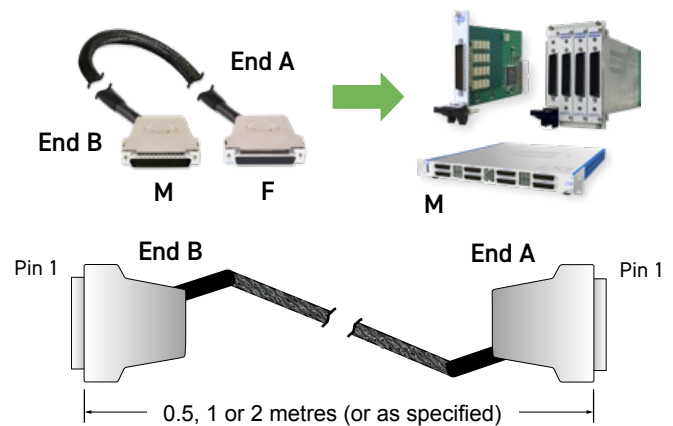

End B - Male Mating Face

End A - Female Mating Face

Characteristic Plots for 40-970-078-1m

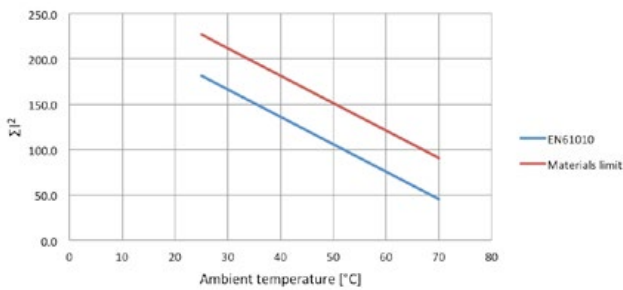

The graph shows the permitted ΣI^2 versus ambient temperature in accordance with EN61010 for user exposure to surface temperature and a higher limit imposed by the materials used where the cable is not directly user accessible.

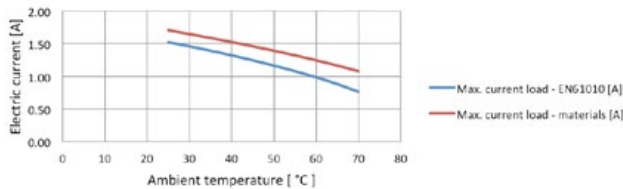

The graph shows the allowed current versus temperature assuming ALL wires carry the same current. Higher currents to the cable rating are permitted on individual wires provided the ΣI^2 is complied with.

Product Order Codes

- 78-Pin D-Type Cable Assy, 3 A, Male to Female,
- 0.5 m Long [40-970-078-0.5m-MF](#)
 - 1.0 m Long [40-970-078-1m-MF](#)
 - 2.0 m Long [40-970-078-2m-MF](#)

Note: Other cable lengths can be supplied. Max length 5 m.

- High Specification Cable
- Highly Flexible Cable with Braided Sleaving
- Fully Screened Cable Construction with Strain Relief
- 45° Cable Exit

Technical Specification

Connector Type (End A):	78-Pin D-Subminiature, Density and a half
Gender	Female
Securing Method	4-40 UNC screwlocks, male
Connector Type (End B):	78-Pin D-Subminiature, Density and a half
Gender	Female
Securing Method	4-40 UNC screwlocks, male
Maximum Current	3 A
Maximum Voltage	250 VAC/400 VDC
Insulation Resistance	1000 MOhm
Connectors:	
Contact Material	Gold plated copper alloy
Contact Resistance	20 mOhm
Cable Exit:	45° (Away from Pin 1)
Overall Size (Approx)	H68 x W18.5 x D55 mm
Cable Type:	Individual wires, screened & sleeved
Conductor: Material	Silver plated copper wire
Strands	7/0.15 (0.124 mm ² , 26AWG)
Resistance	0.137 Ω/m
Insulation	PFA
Outer Sleeve	Polyester
Screened Construction	Yes (Cable screen connected to backshells)
Additional Braided Sleeve	Yes
Cable O/D	12 mm
Minimum Bend Radius	25 mm
Door Closure Allowance	55 mm (see diagram)



78-Pin D-Type Cable Assembly

Product Compatibility

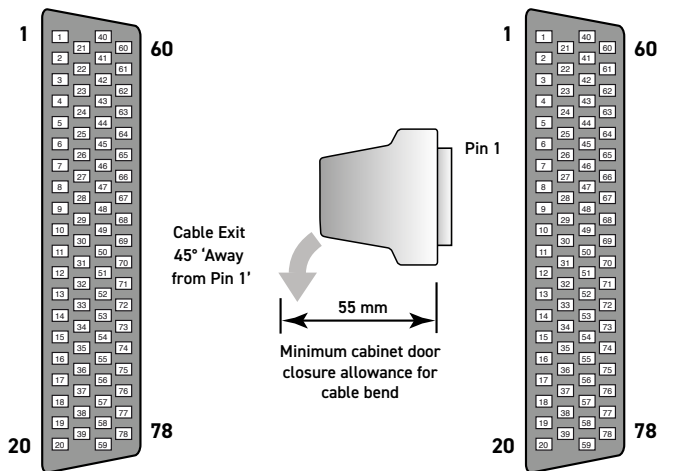
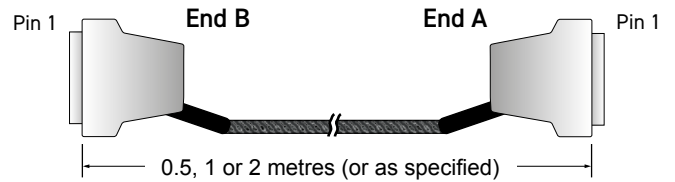
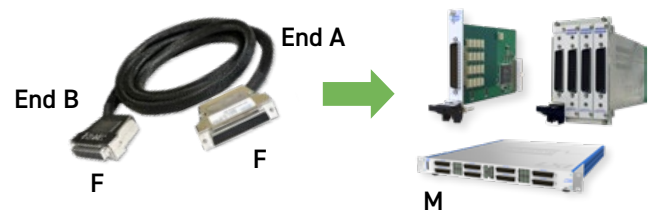

End B - Female Mating Face

End A - Female Mating Face

Characteristic Plots for 40-970-078-1m

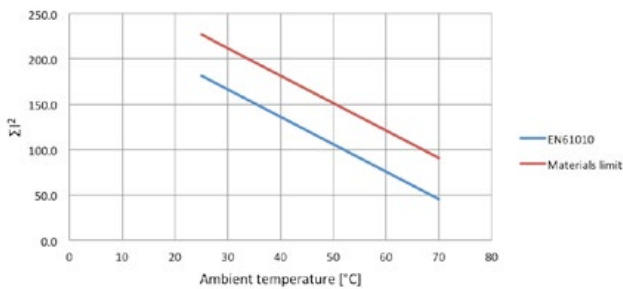

The graph shows the permitted ΣI^2 versus ambient temperature in accordance with EN61010 for user exposure to surface temperature and a higher limit imposed by the materials used where the cable is not directly user accessible.

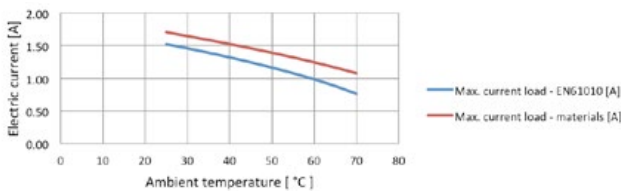

The graph shows the allowed current versus temperature assuming ALL wires carry the same current. Higher currents to the cable rating are permitted on individual wires provided the ΣI^2 is complied with.

Product Order Codes

- 78-Pin D-Type Cable Assy, 3 A, Female to Female,
 0.5 m Long 40-970-078-0.5m-FF
 1.0 m Long 40-970-078-1m-FF
 2.0 m Long 40-970-078-2m-FF

Note: Other cable lengths can be supplied. Max length 5 m.

- High Specification, Highly Flexible Cable
- Fully Screened Cable Construction with Strain Relief
- 45° Cable Exit (Away from Pin 1)
- Fully Coded Markers to Ensure Easy Connection

Technical Specification

Connector Type (End A):	78-Pin D-Subminiature, Density and a half
Gender:	Female
Securing Method:	4-40 UNC screwlocks, male
Unterminated End (End B):	
Free Wire Length:	130 mm nominal
Individual Wire Labelling:	To connector pins A white/black screen pigtail is also included
Wire End Options:	Ferrules, Tinned, Cut End
Maximum Current:	3 A
Maximum Voltage:	250 VAC/400 VDC
Insulation Resistance:	1000 MOhm
Connector:	
Contact Material:	Gold plated copper alloy
Contact Resistance:	20 mOhm
Cable Exit:	45° (Away from Pin 1)
Overall Size (Approx):	H68 x W18.5 x D55 mm
Cable Type:	Individual wires, screened & sleeved
Conductor: Material:	Silver plated copper wire
Strands:	7/0.15 (0.124 mm ² , 26AWG)
Resistance:	0.137 Ω/m
Insulation:	PFA
Outer Sleeve:	Polyester
Screened Construction:	Yes (Cable screen connected to backshell)
Additional Braided Sleeve:	Yes
Cable O/D:	12 mm
Minimum Bend Radius:	25 mm
Door Closure Allowance:	55 mm (see diagram)

Note: When using this product please ensure appropriate electrical safety.

Characteristic Plots for 40-972-078-1m

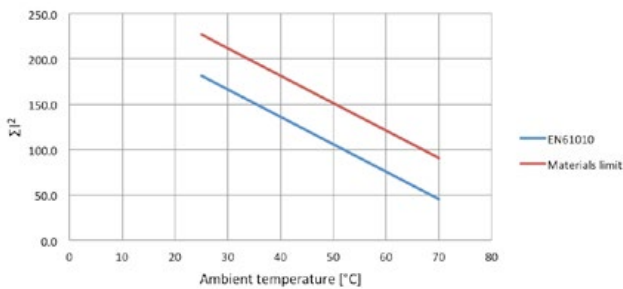

The graph shows the permitted ΣI^2 versus ambient temperature in accordance with EN61010 for user exposure to surface temperature and a higher limit imposed by the materials used where the cable is not directly user accessible.

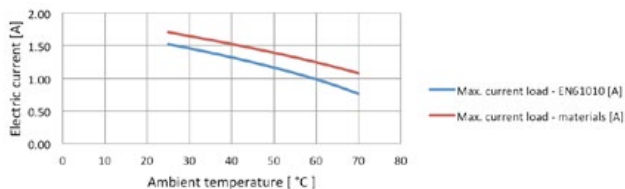

The graph shows the allowed current versus temperature assuming ALL wires carry the same current. Higher currents to the cable rating are permitted on individual wires provided the ΣI^2 is complied with.



78-Pin D-Type Unterminated Cable Assembly

Product Compatibility

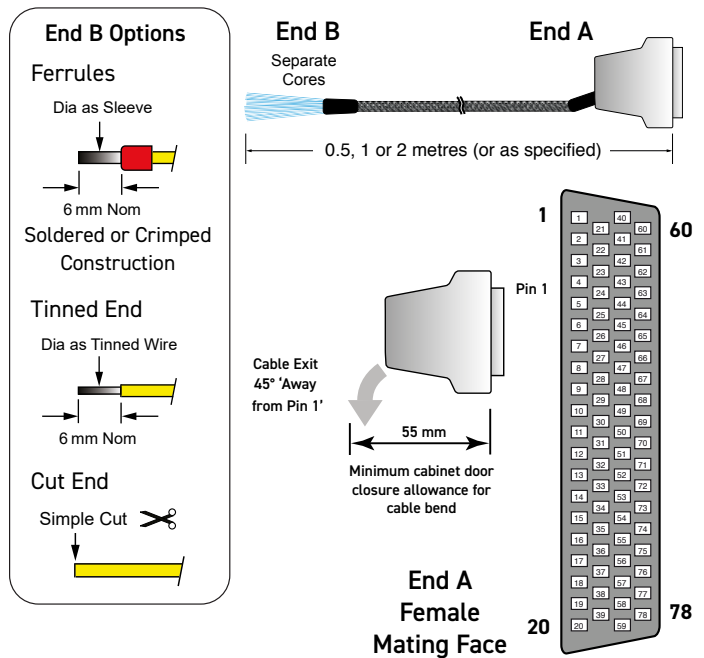
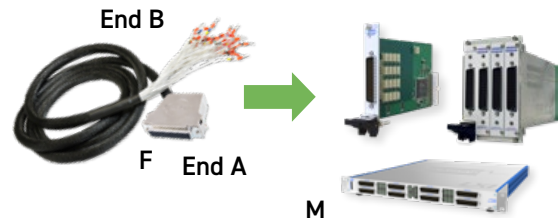

Product Order Codes

78-Pin D-Type Cable Assy, 3 A, Female to Unterminated, Ferrules,
 Cable Exit Away from Pin 1, 0.5 m Lg [40-972-078-0.5m-FU](#)
 Cable Exit Away from Pin 1, 1.0 m Lg [40-972-078-1m-FU](#)
 Cable Exit Away from Pin 1, 2.0 m Lg [40-972-078-2m-FU](#)

Part numbers for other versions:

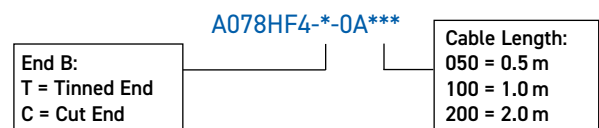

Note: Other cable lengths can be supplied. Max length 5 m.

- High Specification, Highly Flexible Cable
- Fully Screened Cable Construction with Strain Relief
- 45° Cable Exit (Towards Pin 1)
- Fully Coded Markers to Ensure Easy Connection

Technical Specification

Connector Type (End A): Gender Securing Method	78-Pin D-Subminiature, Density and a half Female 4-40 UNC screwlocks, male
Unterminated End (End B): Free Wire Length Individual Wire Labelling	130 mm nominal To connector pins A white/black screen pigtail is also included
Wire End Options	Ferrules, Tinned, Cut End
Maximum Current Maximum Voltage Insulation Resistance	3 A 250 VAC/400 VDC 1000 MOhm
Connector: Contact Material Contact Resistance Cable Exit Overall Size (Approx)	Gold plated copper alloy 20 mOhm 45° (Towards Pin 1) H68 x W18.5 x D55 mm
Cable Type: Conductor: Material Strands Resistance Insulation	Individual wires, screened & sleeved Silver plated copper wire 7/0.15 (0.124 mm ² , 26AWG) 0.137 Ω/m PFA
Outer Sleeve Screened Construction Additional Braided Sleeve	Polyester Yes (Cable screen connected to backshell) Yes
Cable O/D Minimum Bend Radius Door Closure Allowance	12 mm 25 mm 55 mm (see diagram)

Note: When using this product please ensure appropriate electrical safety.

Characteristic Plots for A078HF5-*-0A100

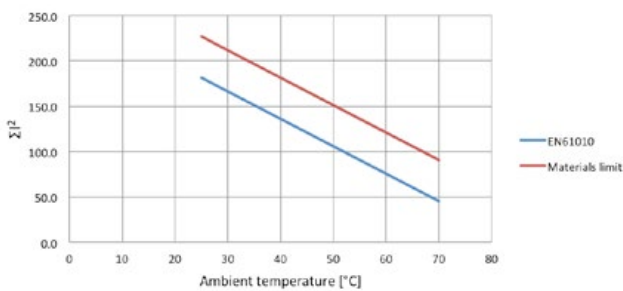

The graph shows the permitted ΣI^2 versus ambient temperature in accordance with EN61010 for user exposure to surface temperature and a higher limit imposed by the materials used where the cable is not directly user accessible.

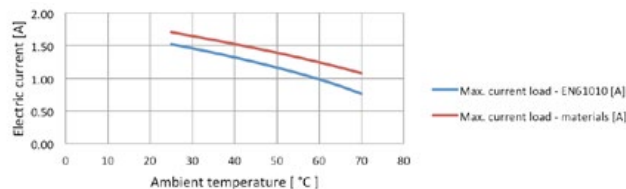

The graph shows the allowed current versus temperature assuming ALL wires carry the same current. Higher currents to the cable rating are permitted on individual wires provided the ΣI^2 is complied with.



78-Pin D-Type Unterminated Cable Assembly

Product Compatibility

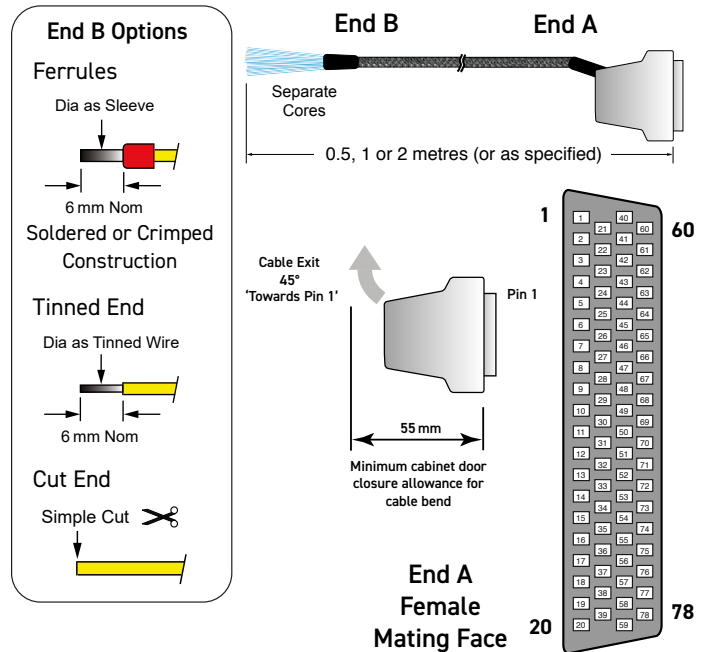
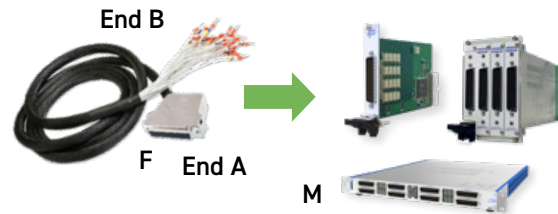

Product Order Codes

- 78-Pin D-Type Cable Assy, 3 A, Female to Unterminated,
Exit Towards Pin 1, Ferrules, 0.5 m Lg [A078HF5-F-0A050](#)
Exit Towards Pin 1, Ferrules, 1.0 m Lg [A078HF5-F-0A100](#)
Exit Towards Pin 1, Ferrules, 2.0 m Lg [A078HF5-F-0A200](#)
Exit Towards Pin 1, Tinned End, 0.5 m Lg [A078HF5-T-0A050](#)
Exit Towards Pin 1, Tinned End, 1.0 m Lg [A078HF5-T-0A100](#)
Exit Towards Pin 1, Tinned End, 2.0 m Lg [A078HF5-T-0A200](#)
Exit Towards Pin 1, Cut End, 0.5 m Lg [A078HF5-C-0A050](#)
Exit Towards Pin 1, Cut End, 1.0 m Lg [A078HF5-C-0A100](#)
Exit Towards Pin 1, Cut End, 2.0 m Lg [A078HF5-C-0A200](#)

Note: Other cable lengths can be supplied. Max length 5 m.

- Compatible with the Millivolt Thermocouple Simulator Modules, 41-760, 41-761 & 41-761A
- High Specification and Highly Flexible Cable
- Braided Sleeve
- Fully Coded Markers to Ensure Easy Connection

Technical Specification

Connector Type (End A):	78-Pin D-Subminiature, density and a half
Gender	Female
Securing Method	4-40 UNC screwlocks, male
Connector Type (End B):	Mini copper thermocouple plugs
Gender	Male
Securing Method	Push Fit
Free Wire Length	100 mm nominal
Individual Wire Labelling	As thermocouple channel
Maximum Current	3 A
Maximum Voltage	125 VAC
Insulation Resistance	3000 MOhm/m
Connector (End A):	
Contact Material	Brass
Contact Resistance	20 mOhm
Cable Exit	45° (Away from Pin 1)
Overall Size (Approx)	H68 x W18.5 x D55 mm
Connector (End B):	
Contact Material	Brass
Max Continuous Temperature	150 °C
Cable Exit:	Rear with cable clamp
Overall Size (Excluding Pins)	H16 x W8 x D20.2 mm
Cable Type:	26 AWG PFA twisted pair
Conductor: Material	Silver plated copper
Strands	7/0.15 mm
Resistance	0.137 Ω/m
Insulation	PFA
Outer Sleeve	-
Screened Construction	No
Additional Braided Sleeve	Yes
Cable O/D	12 mm max
Minimum Bend Radius	25 mm
Door Closure Allowance	55 mm (see diagram)



78-Pin D-Type Underterminated Cable Assembly

Product Compatibility

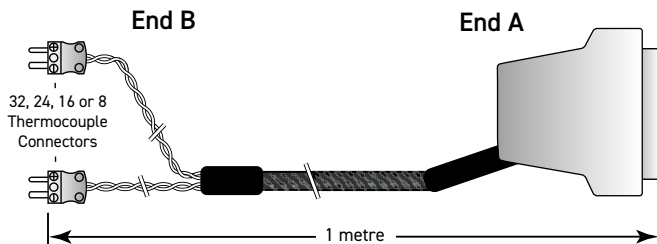
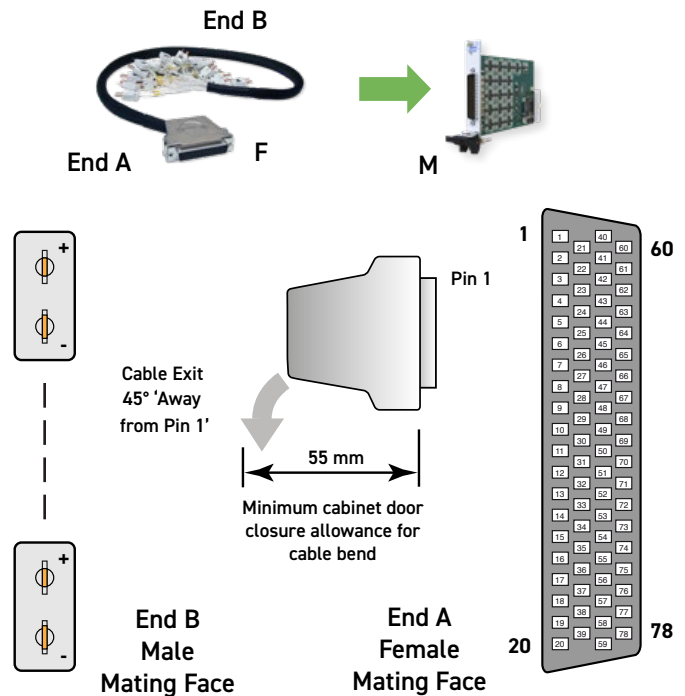

Product Order Codes

- 78-Pin D-Type Cable Assy, 3 A,
 Female to 32 x Mini Thermocouple plugs, 1 m long
[A078DFR-32M002T5A100](#)
 Female to 24 x Mini Thermocouple plugs, 1 m long
[A078DFR-24M002T5A100](#)
 Female to 16 x Mini Thermocouple plugs, 1 m long
[A078DFR-16M002T5A100](#)
 Female to 8 x Mini Thermocouple plugs, 1 m long
[A078DFR-08M002T5A100](#)

Note: Other cable lengths can be supplied.

- Specifically designed to connect to the 78-Pin D-Type front panel port of Pickering Interfaces Thermocouple Simulator Modules 41-760 and 41-761
- Enables calibration via an external DMM
- 2 X 4mm DMM bayonet plugs.

Technical Specification

Connector Type (End A):	78-Pin D-Subminiature, density and a half
Gender	Female
Securing Method	4-40 UNC screwlocks, male
Connector Type (End B):	2 x 4 mm DMM Bayonet Plugs
Gender	Male
Securing Method	Push Fit
Maximum Current	5 A
Maximum Voltage	250 VAC
Insulation Resistance	1000 MΩ
Connector (End A):	
Contact Material	Gold plated copper alloy
Contact Resistance	20 mΩ
Cable Exit	45° (Away from Pin 1)
Overall Size (Approx)	H68 x W18.5 x D55 mm
Connector (End B):	
Contact Material	Gold plated copper alloy
Cable Type:	Stranded Hi-Flex PVC
Conductor: Material	Tinned copper wire
Strands	129/0.07 (0.5 mm) 20 AWG
Resistance	-
Insulation	PVC
Outer Sleeve	Polyester
Screened Construction	No
Additional Braided Sleeve	Yes
Minimum Bend Radius	30 mm
Door Closure Allowance	30 mm (see diagram)

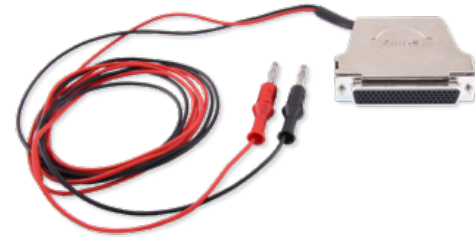
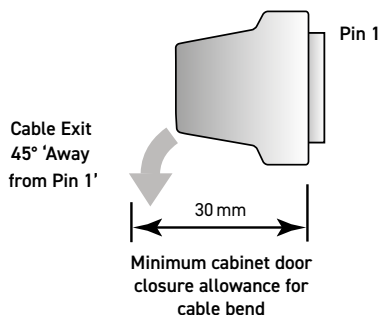

78-Pin D-Type Underterminated Cable Assembly

Product Compatibility

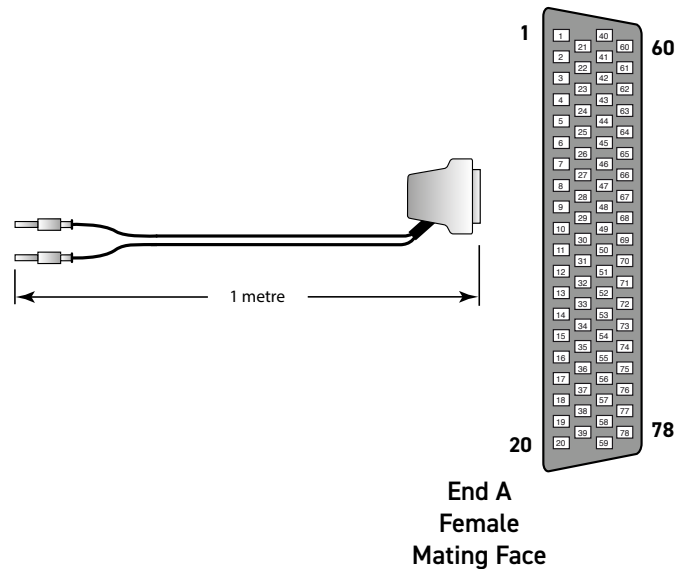
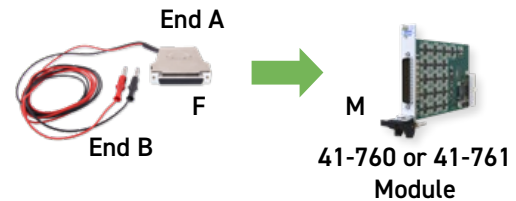

Product Order Codes

78-Pin D-Type Cable Assy, 5 A,
Female to 2 x 4 mm DMM bayonet plugs, 1 m long
[40-975-078-1m](#)

- Connector & PCB Only or Connector, PCB & Backshell
- Male Screwlocks
- Cable Clamp in Backshell
- Easy to Use Rising Cage Screw Terminals

Connector blocks provide a convenient method of termination without the use of custom cabling. However, a higher resistance path, lower capacity ratings and lower voltage ratings are typical.

The screw terminals use a rising cage clamp mechanism to minimize risk of copper strand breakage. PTFE cables are recommended for use with this connector block to maximise copper cross-sectional area and insulation properties. The breakdown voltage of the connector block is controlled by clearances to the metal shell. The metal shell includes an internal insulation barrier under the carrier board.

This connector block uses male screwlocks and will not mate to Pickering cables. Connector blocks supplied without a backshell do not include cable strain relief.

Technical Specification

Connector Type:	78-Pin D-Subminiature, Density and a half
Gender	Female
Securing Method:	
Product with Backshell	4-40 UNC screwlocks, male
Product without Backshell	4-40 UNC screwlocks, male or female
Wire Connection	Rising cage screw terminals A screen (GND) connection is provided
Connector Block Ratings:	
Maximum Current	2 A
Maximum Voltage	200 V DC
Cable Exit	Rear - 15.3 x 30 mm
Overall Size (Approx)	H68 x W18.3 x D102 mm
78-Pin D-Sub:	
Contact Material	Gold plated copper alloy
Contact Resistance	<20 mOhm
Screw Terminals:	
Maximum Wire Size	20AWG
Recommended Insulation	PTFE type
Additional Cable Clamp	Yes (in backshell)

Note: When using this product please ensure appropriate electrical safety.

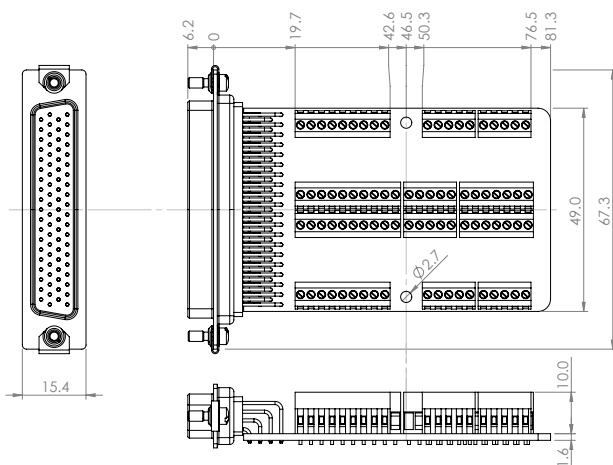

Product Dimensions (92-965-078-F)

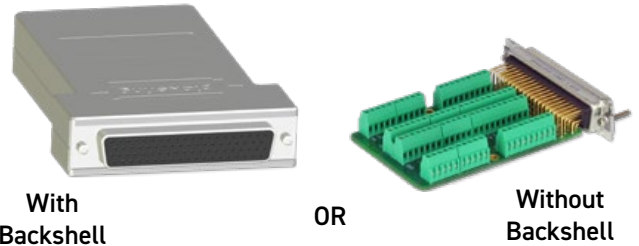

With Backshell

OR

Without Backshell

78-Pin D-Type Connector Block

Product Compatibility

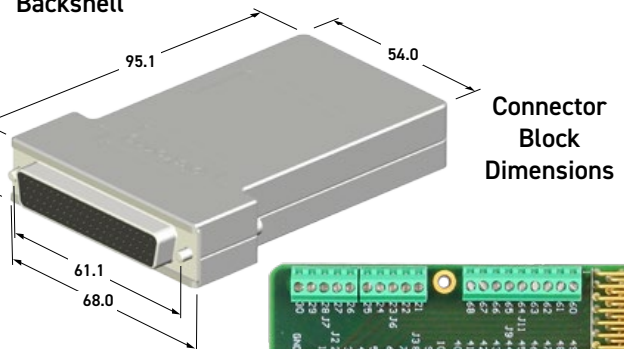
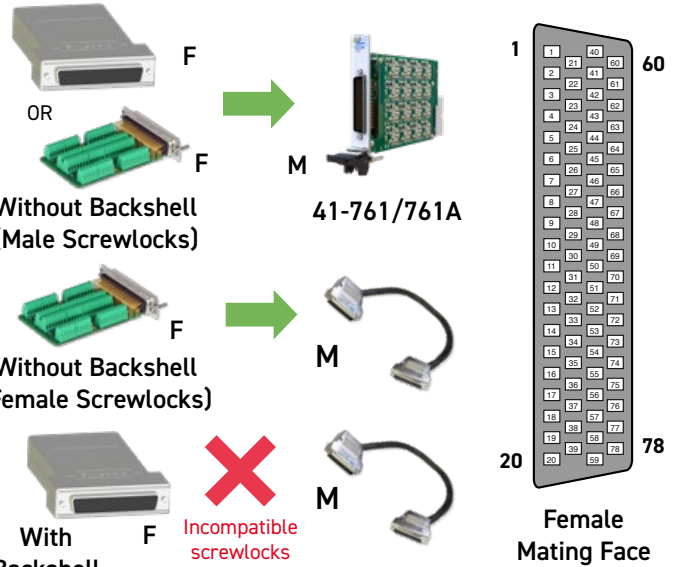

Connector Block Dimensions

Connector Block PCB Legend

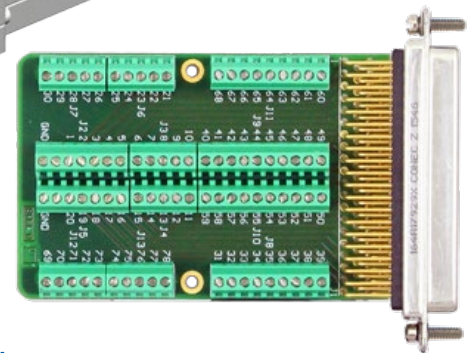

Product Order Codes

- 78-Pin D-Type Shielded Connector Block, 2 A, Screw Terminal, With Backshell, Female [40-965A-078-F](#)
- Without Backshell, Female [92-965-078-F](#)

- Spare 4-40 UNC Male 27.2mm Screwlock [40-969-108](#)

Note: Male and female screwlocks are provided for connector blocks without a backshell.

- For Connection at Cable End
- Simple to Use Rising Cage Screw Clamp Termination
- DIN Rail Mounted

Connector blocks provide a convenient method of termination without the use of custom cabling. However, a higher resistance path, lower capacity ratings and lower voltage ratings are typical.

This termination option is capable of accepting heavy duty connection wires and uses rising clamp screw terminals to minimize the danger of copper strand damage. Users should care take to protect the termination and provide a suitable method of restraining the cables.

When using this product please ensure appropriate electrical safety precautions are observed.

Technical Specification

Connector Type:	78-Pin D-Subminiature, Density and a half Female
Gender	Female
Securing Method:	4-40 UNC screwlocks, female
Wire Connection	Rising cage screw terminals A screen connection is provided
Breakout Ratings:	
Maximum Current	2 A
Maximum Voltage	200 V DC
Securing Method	Suitable for securing to DIN rails
Overall Size (Approx)	H110 x W110 x D56 mm
78-Pin D-Sub:	
Contact Material	Gold plated copper alloy
Contact Resistance	<20 mOhm
Screw Terminals:	
Maximum Wire Size	12AWG
Additional Cable Clamp	No

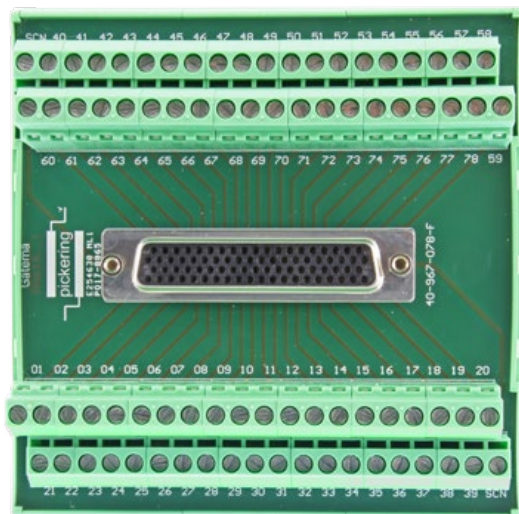

PCB Layout

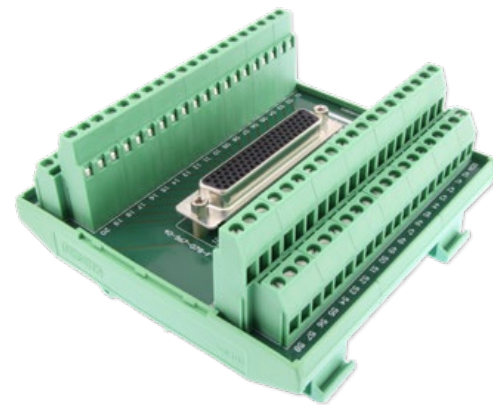

78-Pin D-Type Breakout

Product Compatibility

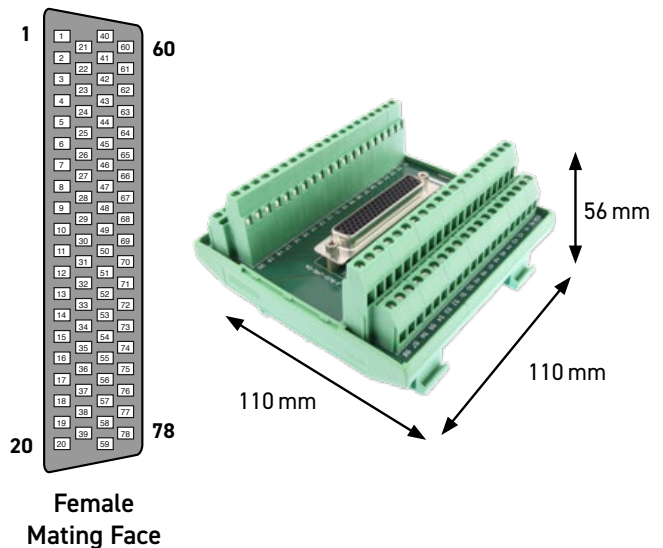
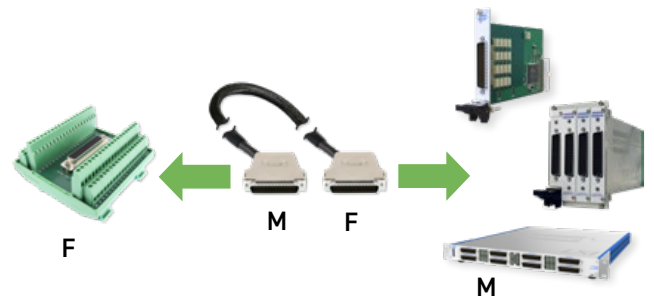

Product Order Codes

78-Pin D-Type Breakout with DIN Rail Mount, 2 A, Screw Terminal, Female [40-967-078-F](#)

- Connector only or Connector and Backshell
- Cable Clamp in Backshell
- Soldered Cable Termination

This accessory is designed to allow users to directly terminate with soldered connections to the connector.

Connector and shell are supplied separately to allow the user to determine the direction of the cable exit.

When the product is used without a backshell users should make their own cable strain relief arrangements and ensure appropriate electrical safety precautions are observed.

Technical Specification

Connector Type:	78-Pin D-Subminiature, Density and a half Female
Gender	Female
Securing Method:	
Product with Backshell	4-40 UNC screwlocks, male
Product without Backshell	4-40 UNC screwlocks, male
Wire Connection	Solder bucket. A backshell fixing is also provided for a cable screen
Connector Ratings:	
Maximum Current	3 A
Maximum Voltage	250 V AC
Cable Exit:	45°
Cable Exit Size	12 mm dia
Overall Size (Approx)	H68 x W18.5 x D55 mm
78-Pin D-Sub:	
Contact Material	Gold plated copper alloy
Contact Resistance	20 mOhm
Wire Connection:	
Maximum Wire Size	22AWG
Recommended Insulation	PFA
Additional Cable Clamp	Yes (in backshell)

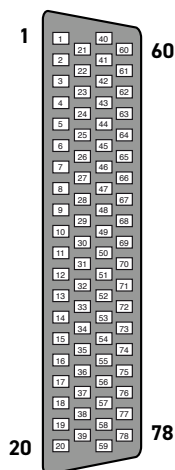

Female Mating Face

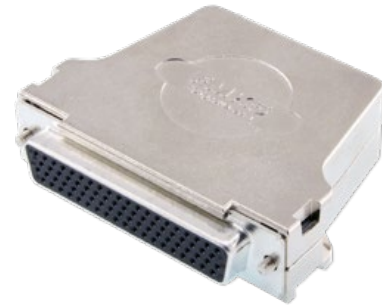

78-Pin D-Type Cable Connector with Backshell

Product Compatibility

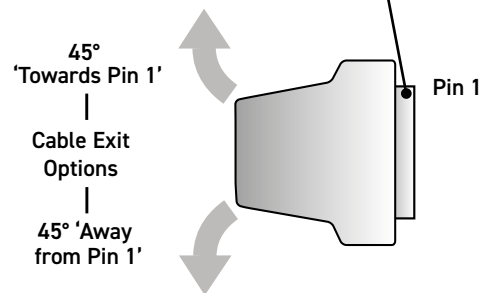
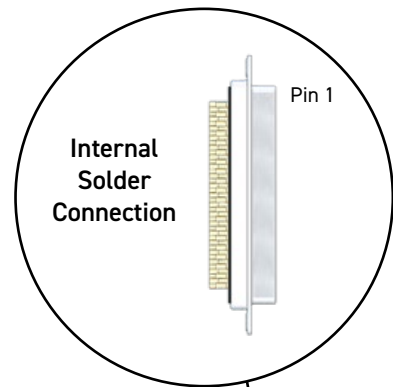
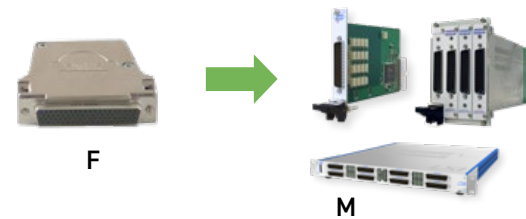

Product Order Codes

78-Pin D-Type Connector, 3 A, Solder Bucket, With Backshell, Female	40-960-078-F
Without Backshell, Female	92-960-078-F

- Right Angle PCB Mount
- Ideal for User Created Termination Solutions

This accessory allows a user to create their own PCB based termination solution mounted on the end of a cable. Suitable cables for this product are contained elsewhere in this data sheet. Interfacing PCBs should be designed with suitable clearances for the voltage the application requires.

Note: This product is not suitable for directly mounting onto the front panel of a Pickering switching product.



78-Pin D-Type PCB Connector

Technical Specification

Connector Type:	78-Pin D-Subminiature, Density and a half
Gender	Female
Securing Method	4-40 UNC screwlocks, female
PCB Mounting	Right angle PCB mount, solder
Connector Ratings:	
Maximum Current	3 A each pin
Maximum Voltage	250 V AC
78-Pin D-Sub:	
Contact Material	Gold plated copper alloy
Contact Resistance	<20 mOhm
PCB Legs:	
Effective Leg Length	3.0 mm nom (See diagram)

Product Compatibility

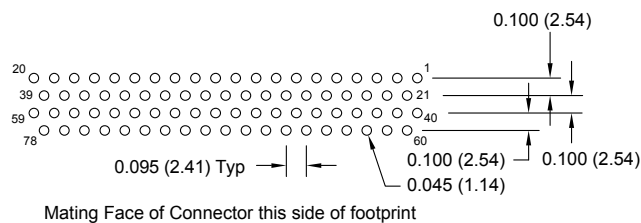
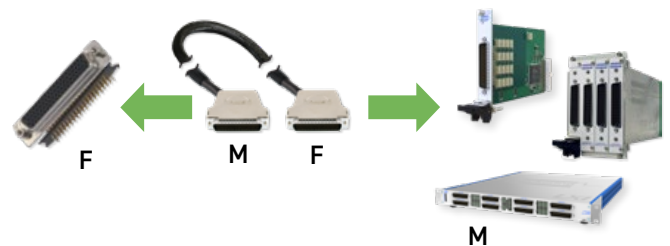

PCB Footprint of 78-Pin Right Angle Female Connector
(Connector Side - Not to Scale)

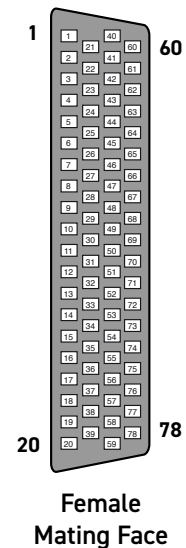
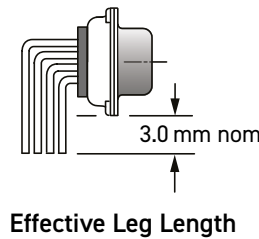

Product Order Codes

78-Pin D-Type Connector, 3 A, Right Angle PCB Mount, Female

[40-963-078-RF](#)

- Straight PCB Mount
- Ideal for User Created Termination Solutions

This accessory allows a user to create their own PCB based termination solution mounted on the end of a cable. Suitable cables for this product are contained elsewhere in this data sheet. Interfacing PCBs should be designed with suitable clearances for the voltage the application requires.

Note: This product is not suitable for directly mounting onto the front panel of a Pickering switching product.



78-Pin D-Type PCB Connector

Technical Specification

Connector Type:	78-Pin D-Subminiature, Density and a half
Gender	Female
Securing Method	4-40 UNC screwlocks, female
PCB Mounting	Straight PCB mount, solder
Connector Ratings:	
Maximum Current	3 A each pin
Maximum Voltage	250 V AC
78-Pin D-Sub:	
Contact Material	Gold plated copper alloy
Contact Resistance	<20 mOhm
PCB Legs:	
Leg Length	5.0 mm nom (See diagram)

Product Compatibility

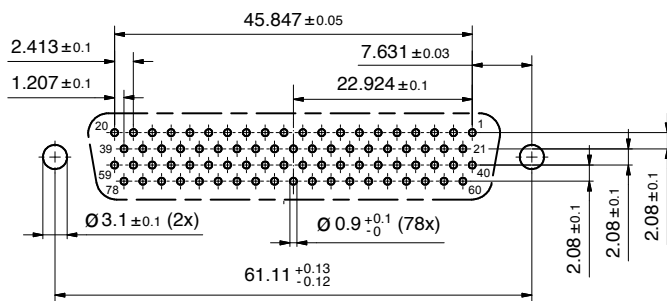
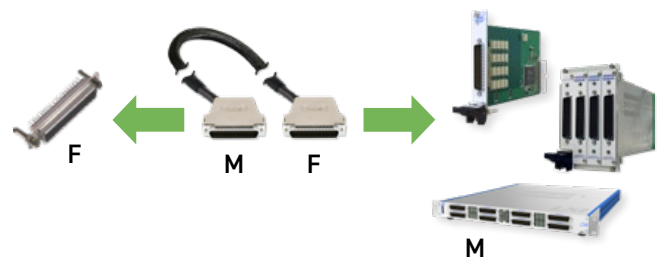

PCB Footprint of 78-Pin Straight Female Connector
(Connector Side - Not to Scale)

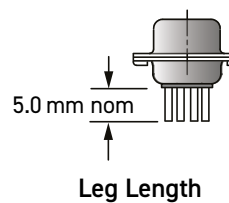

Leg Length

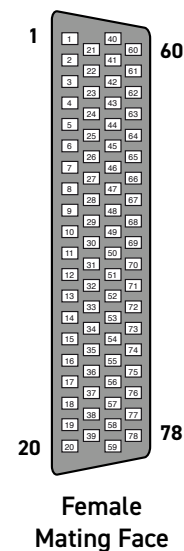

Female Mating Face

Product Order Codes

78-Pin D-Type Connector, 3 A, Straight PCB Mount, Female [40-963-078-SF](#)

- For Connection at Cable End
- Simple to Use Rising Cage Screw Clamp Termination
- DIN Rail Mounted

Connector blocks provide a convenient method of termination without the use of custom cabling. However, a higher resistance path, lower capacity ratings and lower voltage ratings are typical.

This termination option is capable of accepting heavy duty connection wires and uses rising clamp screw terminals to minimize the danger of copper strand damage. Users should care take to protect the termination and provide a suitable method of restraining the cables.

When using this product please ensure appropriate electrical safety precautions are observed.

Technical Specification

Connector Type:	78-Pin D-Subminiature, Density and a half
Gender	Male
Securing Method:	4-40 UNC screwlocks, female
Wire Connection	Rising cage screw terminals A screen connection is provided
Breakout Ratings:	
Maximum Current	2 A
Maximum Voltage	200 V DC
Securing Method	Suitable for securing to DIN rails
Overall Size (Approx)	H110 x W110 x D56 mm
78-Pin D-Sub:	
Contact Material	Gold plated copper alloy
Contact Resistance	<20 mOhm
Screw Terminals:	
Maximum Wire Size	12AWG
Additional Cable Clamp	No

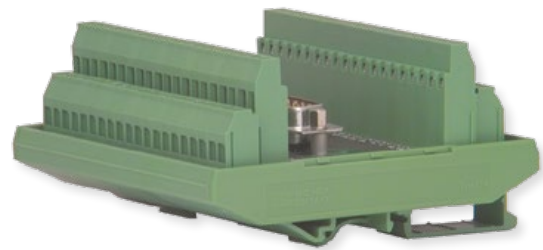

78-Pin D-Type Breakout

Product Compatibility

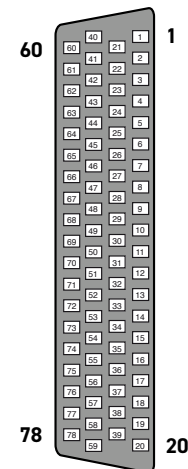
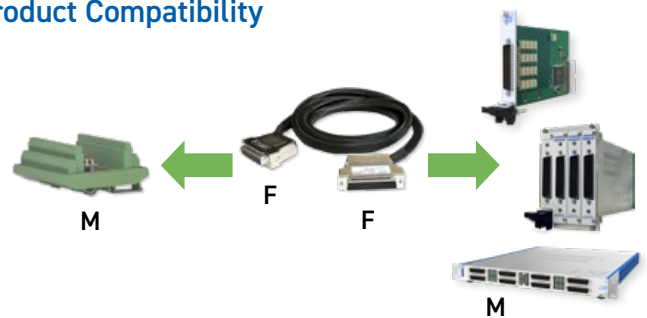

Male Mating Face

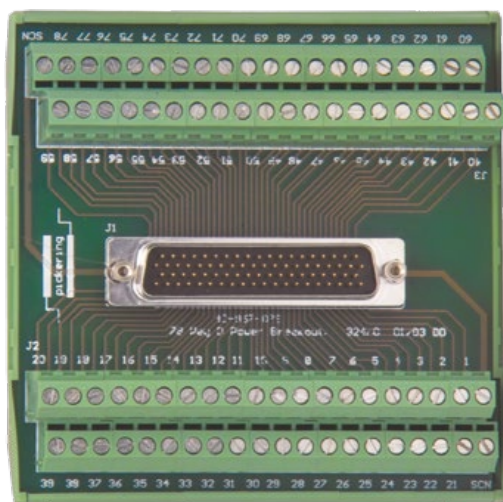

PCB Legend

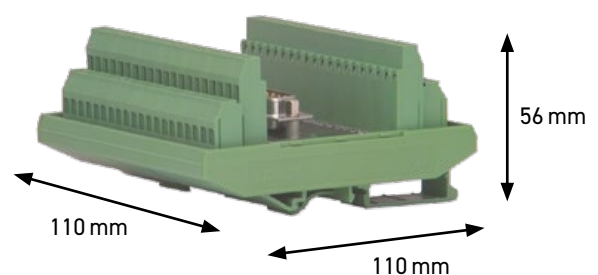

Breakout Dimensions

Product Order Codes

78-Pin D-Type Breakout with DIN Rail Mount, 2 A,
Screw Terminal, Male [40-967-078-M](https://www.pickeringtest.com/Products/90-967-078-M)

- Right Angle PCB Mount
- Ideal for User Created Termination Solutions

This accessory allows a user to create their own PCB based termination solution mounted on the end of a cable. Suitable cables for this product are contained elsewhere in this data sheet. Interfacing PCBs should be designed with suitable clearances for the voltage the application requires.

Note: This product is not suitable for directly mounting onto the front panel of a Pickering switching product.

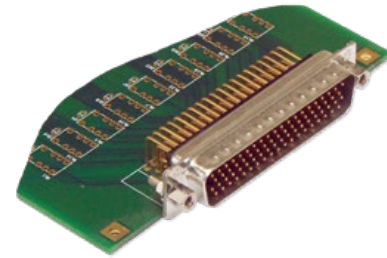

78-Pin D-Type PCB Connector
(PCB not supplied)

Product Compatibility

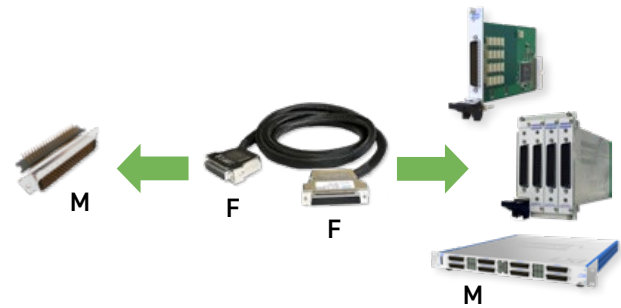

Technical Specification

Connector Type:	78-Pin D-Subminiature, Density and a half
Gender	Male
Securing Method	4-40 UNC screwlocks, female
PCB Mounting	Right angle PCB mount, solder
Connector Ratings:	
Maximum Current	3 A each pin
Maximum Voltage	250 V AC
78-Pin D-Sub:	
Contact Material	Gold plated copper alloy
Contact Resistance	<20 mOhm
PCB Legs:	
Effective Leg Length	3.0 mm nom (See diagram)

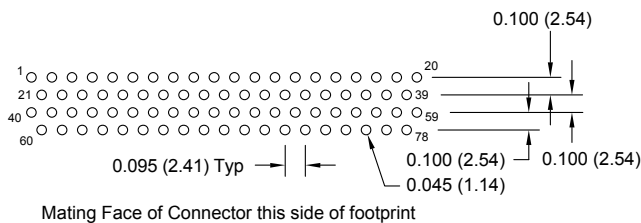

PCB Footprint of 78-Pin Right Angle Male Connector
(Connector Side - Not to Scale)

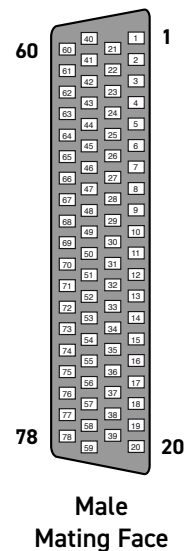
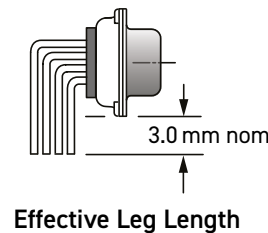

Product Order Codes

78-Pin D-Type Connector, 3 A, Right Angle PCB Mount, Male [40-963-078-RM](#)

- Straight PCB Mount
- Ideal for User Created Termination Solutions

This accessory allows a user to create their own PCB based termination solution mounted on the end of a cable. Suitable cables for this product are contained elsewhere in this data sheet. Interfacing PCBs should be designed with suitable clearances for the voltage the application requires.

Note: This product is not suitable for directly mounting onto the front panel of a Pickering switching product.

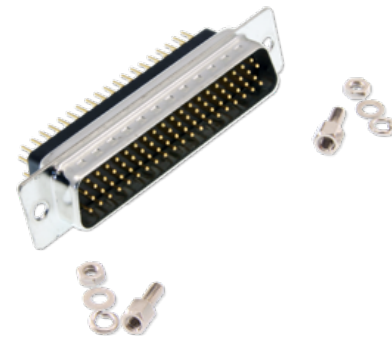

78-Pin D-Type PCB Connector

Technical Specification

Connector Type:	78-Pin D-Subminiature, Density and a half
Gender	Male
Securing Method	4-40 UNC screwlocks, female
PCB Mounting	Straight PCB mount, solder
Connector Ratings:	
Maximum Current	3 A each pin
Maximum Voltage	250 V AC
78-Pin D-Sub:	
Contact Material	Gold plated copper alloy
Contact Resistance	<20 mOhm
PCB Legs:	
Leg Length	5.0 mm nom (See diagram)

Product Compatibility

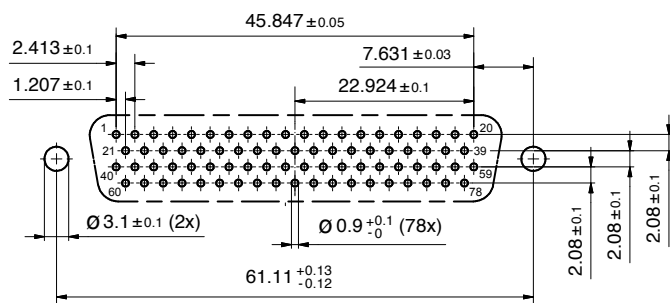
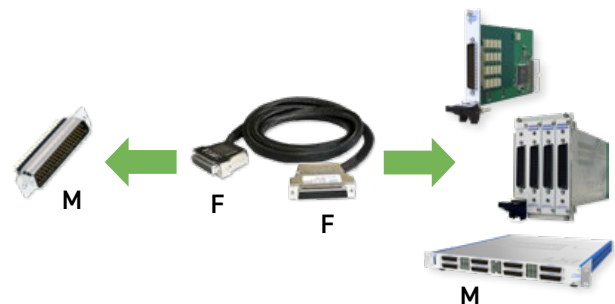

PCB Footprint of 78-Pin Straight Male Connector
(Connector Side - Not to Scale)

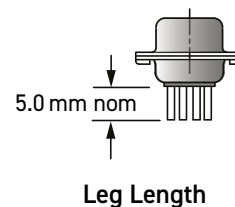

Leg Length

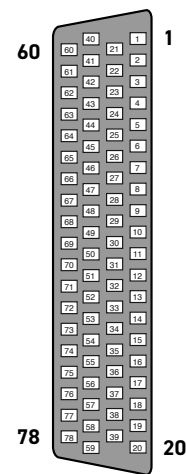

Male Mating Face

Product Order Codes

78-Pin D-Type Connector, 3 A, Straight PCB Mount, Male [40-963-078-SM](#)

Additional Connection Accessories

Although these items do not directly mate with Pickering Interfaces products customers may find them useful in the development of their own connection solutions.

- High Specification Cable
- Highly Flexible Cable with Braided Slewing
- Fully Screened Cable Construction with Strain Relief
- 45° Cable Exit

Technical Specification

Connector Type (End A):	78-Pin D-Subminiature, Density and a half
Gender	Male
Securing Method	4-40 UNC screwlocks, male
Connector Type (End B):	78-Pin D-Subminiature, Density and a half
Gender	Male
Securing Method	4-40 UNC screwlocks, male
Maximum Current	3 A
Maximum Voltage	250 VAC/400 VDC
Insulation Resistance	1000 MOhm
Connectors:	
Contact Material	Gold plated copper alloy
Contact Resistance	20 mOhm
Cable Exit:	45° (Towards Pin 1)
Overall Size (Approx)	H68 x W18.5 x D55 mm
Cable Type:	Individual wires, screened & sleeved
Conductor: Material	Silver plated copper wire
Strands	7/0.15 (0.124 mm ² , 26AWG)
Resistance	0.137 Ω/m
Insulation	PFA
Outer Sleeve	Polyester
Screened Construction	Yes (Cable screen connected to backshells)
Additional Braided Sleeve	Yes
Cable O/D	12 mm
Minimum Bend Radius	25 mm
Door Closure Allowance	55 mm (see diagram)

This Cable Assembly is Not Suitable for Connection to a Pickering Switching Product

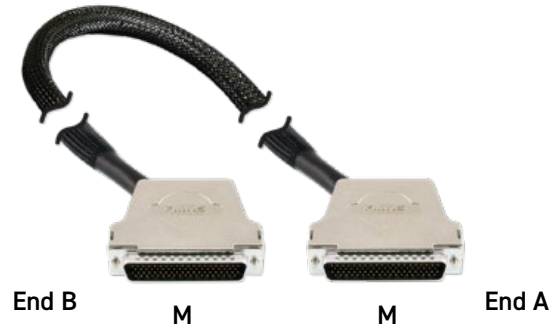

78-Pin D-Type Cable Assembly

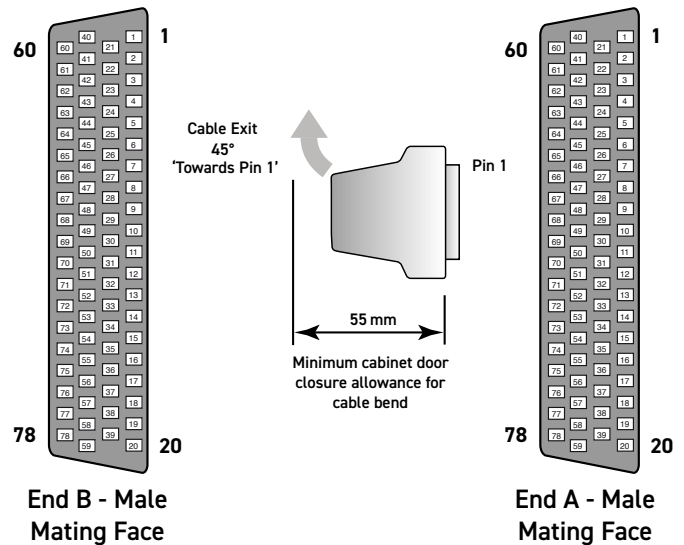
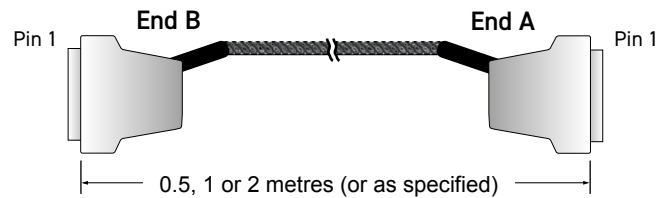

Characteristic Plots for 40-970-078-1m

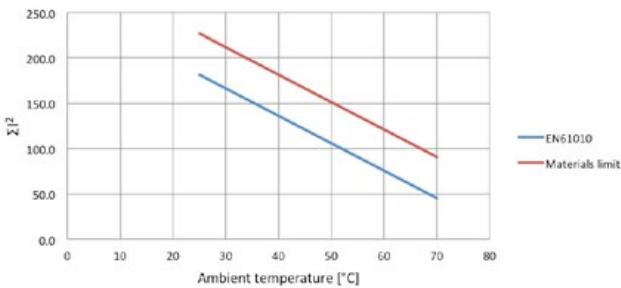

The graph shows the permitted ΣI^2 versus ambient temperature in accordance with EN61010 for user exposure to surface temperature and a higher limit imposed by the materials used where the cable is not directly user accessible.

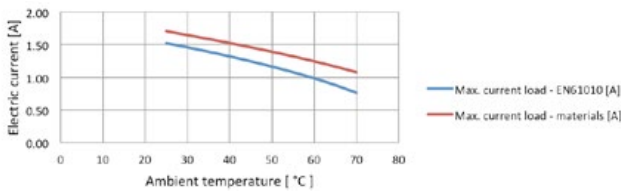

The graph shows the allowed current versus temperature assuming ALL wires carry the same current. Higher currents to the cable rating are permitted on individual wires provided the ΣI^2 is complied with.

Product Order Codes

- 78-Pin D-Type Cable Assy, 3 A, Male to Male,
- 0.5 m Long [40-970-078-0.5m-MM](#)
 - 1.0 m Long [40-970-078-1m-MM](#)
 - 2.0 m Long [40-970-078-2m-MM](#)

Note: 1. The Male gender **Will Not Mate** with a Pickering Module.
2. Other cable lengths can be supplied. Max length 5 m.

- High Specification, Highly Flexible Cable
- Fully Screened Cable Construction with Strain Relief
- 45° Cable Exit
- Fully Coded Markers to Ensure Easy Connection

Technical Specification

Connector Type (End A):	78-Pin D-Subminiature, Density and a half
Gender	Male
Securing Method	4-40 UNC screwlocks, male
Unterminated End (End B):	
Free Wire Length	130 mm nominal
Individual Wire Labelling	To connector pins
Wire End Options	A white/black screen pigtail is included Ferrules, Tinned, Cut End
Maximum Current	3 A
Maximum Voltage	250 VAC/400 VDC
Insulation Resistance	1000 MOhm
Connector:	
Contact Material	Gold plated copper alloy
Contact Resistance	20 mOhm
Cable Exit	45° (Towards Pin 1)
Overall Size (Approx)	H68 x W18.5 x D55 mm
Cable Type:	Individual wires, screened & sleeved
Conductor: Material	Silver plated copper wire
Strands	7/0.15 (0.124 mm ² , 26AWG)
Resistance	0.137 Ω/m
Insulation	PFA
Outer Sleeve	Polyester
Screened Construction	Yes (Cable screen connected to backshell)
Additional Braided Sleeve	Yes
Cable O/D	12 mm
Minimum Bend Radius	25 mm
Door Closure Allowance	55 mm (see diagram)

Note: When using this product please ensure appropriate electrical safety.

Characteristic Plots for 40-972-078-1m

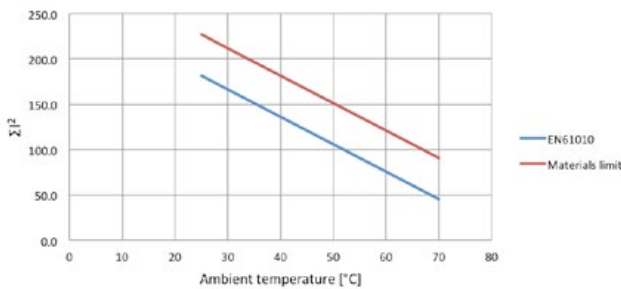

The graph shows the permitted ΣI^2 versus ambient temperature in accordance with EN61010 for user exposure to surface temperature and a higher limit imposed by the materials used where the cable is not directly user accessible.

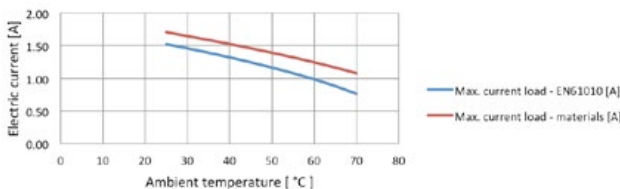

The graph shows the allowed current versus temperature assuming ALL wires carry the same current. Higher currents to the cable rating are permitted on individual wires provided the ΣI^2 is complied with.

This Cable Assembly is Not Suitable for Connection to a Pickering Switching Product

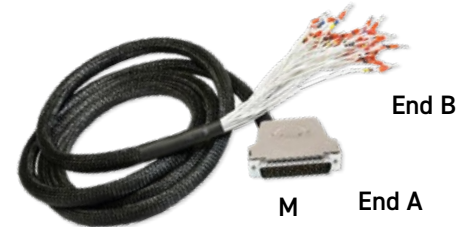

78-Pin D-Type Unterminated Cable Assembly

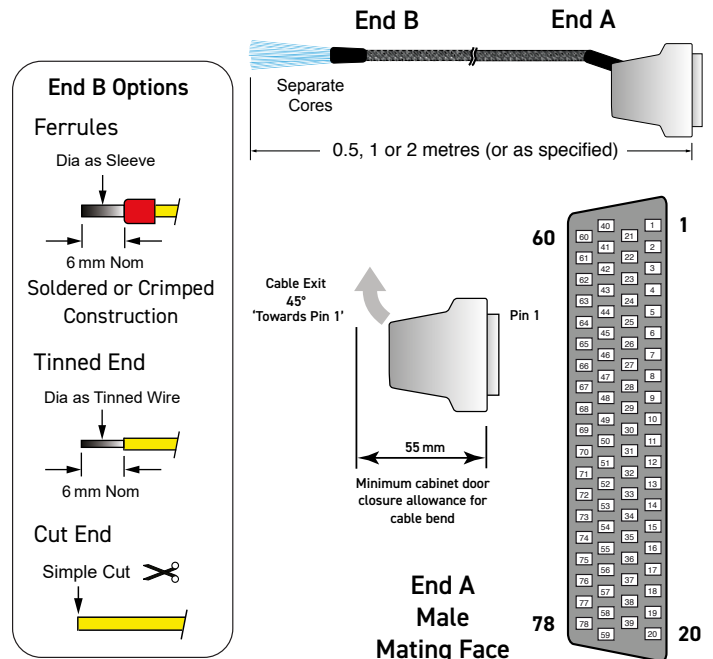

Product Order Codes

78-Pin D-Type Cable Assy, 3 A, Male to Unterminated, Ferrules,

Cable Exit Towards Pin 1, 0.5 m Long [40-972-078-0.5m-MU](#)

Cable Exit Towards Pin 1, 1.0 m Long [40-972-078-1m-MU](#)

Cable Exit Towards Pin 1, 2.0 m Long [40-972-078-2m-MU](#)

Part numbers for other versions:

End B: T = Tinned End C = Cut End	A078HM5*-0A***	Cable Length: 050 = 0.5 m 100 = 1.0 m 200 = 2.0 m
-----------------------------------------	-----------------------	------------------------------------------------------------

Note: 1. The Male gender **Will Not Mate** with a Pickering Module.
2. Other cable lengths can be supplied. Max length 5 m.

- Connector only or Connector and Backshell
- Cable Clamp in Backshell
- Soldered Cable Termination

This accessory is designed to allow users to directly terminate with soldered connections to the connector.

Connector and shell are supplied separately to allow the user to determine the direction of the cable exit.

When the product is used without a backshell users should make their own cable strain relief arrangements and ensure appropriate electrical safety precautions are observed.

Technical Specification

Connector Type:	78-Pin D-Subminiature, Density and a half
Gender	Male
Securing Method:	
Product with Backshell	4-40 UNC screwlocks, male
Product without Backshell	4-40 UNC screwlocks, male
Wire Connection	Solder bucket. A backshell fixing is also provided for a cable screen
Connector Ratings:	
Maximum Current	3 A
Maximum Voltage	250 V AC
Cable Exit:	45 °
Cable Exit Size	12 mm dia
Overall Size (Approx)	H68 x W18.5 x D55 mm
78-Pin D-Sub:	
Contact Material	Gold plated copper alloy
Contact Resistance	20 mOhm
Wire Connection:	
Maximum Wire Size	22AWG
Recommended Insulation	PFA
Additional Cable Clamp	Yes (in backshell)

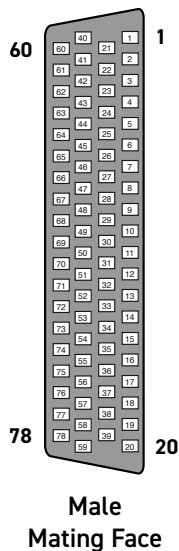

This Connector is Not Suitable for Connection to a Pickering Switching Product

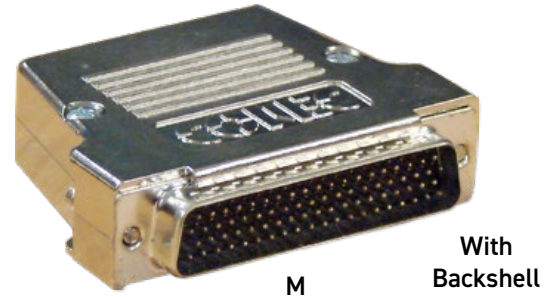

78-Pin D-Type Cable Connector with Backshell

Product Compatibility

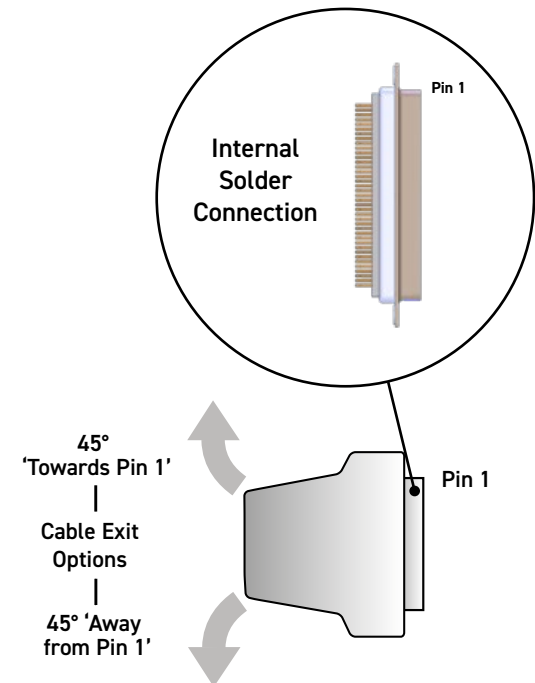

Product Order Codes

78-Pin D-Type Connector, 3 A, Solder Bucket,
 With Backshell, Male [40-960-078-M](https://www.pickeringtest.com/products/40-960-078-M)
 Without Backshell, Male [92-960-078-M](https://www.pickeringtest.com/products/92-960-078-M)

Note: The Male gender **Will Not Mate** with a Pickering Module.

- Cable Support for Rack Mounted LXI Modules
- Sturdy Blue Anodized Aluminium Support Bar
- Slotted for Cable Suspension Using Straps
- 50 mm, 75 mm or 100 mm Deep
- Additional Support Pillars Available

Suitable cable support ensures connection reliability for rack systems by maintaining minimum bend radii of cables and relieving undue strain on connectors and screwlocks. Pickering recommends the use of cable support for all rack mounted applications.

The 63-970 Rack Mount Cable Management Bar Kit provides a robust support system for cables and connectors interfacing with rack mounted LXI modules. It features a sturdy blue anodized aluminium support bar with zinc plated steel support pillars supplied in depths of 50, 75 or 100 mm. Cables can be supported directly on the bar, or suspended with straps from the slots.

Additional pillars are available to create custom depths over 100 mm where required.



Rack Utilizing Cable Support Management Kits



Rack Mount Cable Management Bar Kit (50mm)



Additional Support Pillars

Product Order Codes

Rack Mount Cable Management Bar Kit	
50 mm Deep	63-970-050
75 mm Deep	63-970-075
100 mm Deep	63-970-100
Additional Support Pillars (x2)	
2 x 50 mm Deep	63-960-050
2 x 75 mm Deep	63-960-075
2 x 100 mm Deep	63-960-100

Custom Termination

Pickering Interfaces are able to manufacture custom built cable assemblies and backshells that mate with all the connectors we use in our extensive product range and to provide connection solutions for third party products.

We are able to model and manufacture cable assemblies and other termination arrangements to user notes and drawings, and to deal with simple and complex assemblies, and both small and high volume orders.

All products are designed to ensure easy and problem free connection.

We offer a fast turn round of custom items to keep your ordering and integration time scales to a minimum.



Pickering's Cable Design Tool

Our Cable Design Tool is an online tool that allows you to define a cable assembly to exactly meet your requirements.

- Graphical design of customized cable assemblies
- Built-in library of standard cable sets can be used as the basis for customization, or cables can be defined from scratch
- The ability to store cable assemblies in the Cloud and develop them over time
- Each cable design has a PDF documentation file detailing all the specifications
- Allows detailed design including; connector types, wire type, pin definitions, pin & cable labelling, cable bundling, length selection, sleeving, comments, etc.
- Add your own connectors and wires
- Fully supported on major tablet operating systems

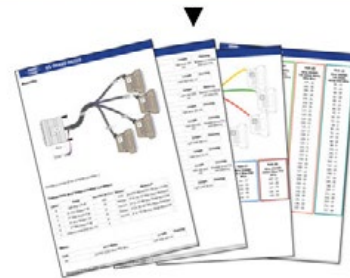
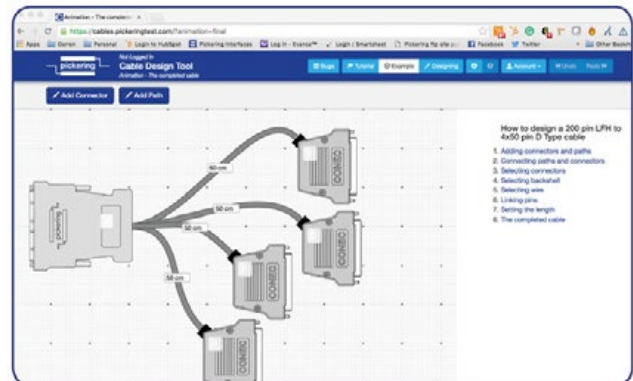

Because the Cable Design Tool is a web-based tool, we will continually update it to better accommodate your requirements and features. Your data is not trapped; complete details of the design are always available to the user at any time via the documentation or spreadsheet file. Once a cable is designed, you can submit it to us for quotation.

For more information visit: pickeringtest.com/cdt