

37-Way D-type Connector Accessories

- **Standard and High Voltage Solutions**
- **Standard Voltage to 250V AC/400V, 5A**
- **High Voltage to 750V Working/1000VDC AC Peak Typical, 5A**
- **Mating connectors**
- **Connector hoods**
- **Connector blocks**
- **Cable assemblies**
- **Guaranteed compatibility**



The Standard Voltage 37-Way D-Type connector is used on PXI and LXI switching products to provide a medium density user connector solution.

The High Voltage 37-Way D-Type connector is used on high voltage PXI switching products to provide a high voltage connector solution. Pickering Interfaces has developed a full range of standard connection solutions to simplify the task of integrating products into a test system.

For users wishing to develop their own cabling solutions, we offer mating connectors and connector hoods which allow users to create either their own cable based solutions, or a PCB header solution. Connector Blocks directly terminate the module connector and convert the connection to arrays of screw terminal blocks, or users can select to use a remote DIN rail mounted breakout to terminate the cables at the end of a cable assembly.

Connector to Connector cable assemblies provide a simple way of connecting the product to the user's remote matching connection. Connectors to unterminated solutions allow the user to connect directly to the product connector and wire directly into a remote UUT. Cable assemblies are offered in various lengths to match most user requirements.

Pickering Interfaces can manufacture custom connector accessories to suit any application, if you do not see what you need then contact your Pickering Interfaces sales office with information on your requirements and let us solve your connection problems.



Sales Offices and Support

© Copyright (2014) Pickering Interfaces Ltd. All Rights Reserved.

Pickering Interfaces Inc. USA
Tel: +1 541 471 0700
e-mail: ussales@pickeringtest.com

Pickering Interfaces Inc. USA East Coast
Tel: +1 781 897 1710
e-mail: ussales@pickeringtest.com

Pickering Interfaces Ltd. United Kingdom
Tel: +44 (0)1255-687900
e-mail: sales@pickeringtest.com

Pickering Interfaces GmbH Germany
Tel: +49 89 125 953 160
e-mail: desales@pickeringtest.com





Pickering Interfaces Sarl France
Tel: +33 1 60 53 55 50
e-mail: frsales@pickeringtest.com

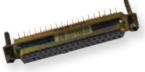

Pickering Interfaces AB Sweden
Tel: +46 340-69 06 69
e-mail: ndsales@pickeringtest.com

Pickering Interfaces s.r.o. Czech Republic
Tel: +420 558 987 613
e-mail: desales@pickeringtest.com

MTCS Systems Engineering Co. Ltd China
Telephone: 86-10-5881-6565
e-mail: sales@mtcs.com.cn



CONTENTS



STANDARD VOLTAGE - Connectors / Connector Blocks					
VIEW	DESCRIPTION	TYPE	GENDER	PART No.	PAGE
	PCB Connector 37 Way D-Type, 5A	Right Angle PCB Mount	Female	40-963-037-RF	Page 4
			Male	40-963-037-RM	
		Straight PCB Mount	Female	40-963-037-SF	Page 5
			Male	40-963-037-SM	
	Cable Connector 37 Way D-Type, 5A, Solder Bucket	With Backshell	Female	40-960-037-F	Page 6
		Without Backshell		92-960-037-F	
		With Backshell	Male	40-960-037-M	
		Without Backshell		92-960-037-M	
	Connector Block, 37 Way D-Type , 5A, Screw Terminal.	With Backshell	Female	40-965-037-F	Page 7
		Without Backshell		92-965-037-F	
		With Backshell	Male	40-965-037-M	
		Without Backshell		92-965-037-M	
	Breakout with DIN Rail Mount, 37 Way D-Type, 5A, Screw Terminal		Female	40-967-037-F	Page 8
			Male	40-967-037-M	

STANDARD VOLTAGE - Cable Assemblies					
VIEW	DESCRIPTION	END 1	END 2	PART No.	PAGE
	Cable Assy, 37 Way D-Type, 5A, 0.5m, 1m and 2m Custom lengths by quotation	Female	Female	40-970-037-*m-FF	Page 9
		Male	Male	40-970-037-*m-MM	
		Male	Female	40-970-037-*m-MF	
	Cable Assy, 37 Way D-Type to Unterminated, 5A, 0.5m, 1m and 2m Custom lengths by quotation	Female	Unterminated with Ferrules	40-972-037-*m-FU	Page 10
		Male	Unterminated with Ferrules	40-972-037-*m-MU	

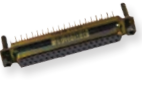
Please use the hyperlinked text to navigate to the data sheet page required. Return to this page via the [C](#) button.

CONTENTS

HIGH VOLTAGE - Connectors / Connector Blocks					
VIEW	DESCRIPTION	TYPE	GENDER	PART No.	PAGE
	PCB Connector 37 Way D-Type, 5A, High Voltage	Right Angle PCB Mount	Female	40-963-037-RF-HV	Page 11
			Male	40-963-037-RM-HV	
		Straight PCB Mount	Female	40-963-037-SF-HV	Page 12
			Male	40-963-037-SM-HV	
	Cable Connector 37 Way D-Type, 5A, Solder Pin, High Voltage	With Backshell	Female	40-960-037-F-HV	Page 13
		Without Backshell		92-960-037-F-HV	
		With Backshell	Male	40-960-037-M-HV	
		Without Backshell		92-960-037-M-HV	

HIGH VOLTAGE - Cable Assemblies					
VIEW	DESCRIPTION	END 1	END 2	PART No.	PAGE
	Cable Assy, 37 Way D-Type 5A, High Voltage 0.5m, 1m and 2m Custom lengths by quotation	Female	Female	40-970-037-*m-FF-HV	Page 14
		Male	Male	40-970-037-*m-MM-HV	
		Male	Female	40-970-037-*m-MF-HV	
	Cable Assy, 37 Way D-Type to Unterminated, 5A, High Voltage 0.5m, 1m and 2m Custom lengths by quotation	Female	Unterminated with Ferrules	40-972-037-*m-FU-HV	Page 15
		Male	Unterminated with Ferrules	40-972-037-*m-MU-HV	

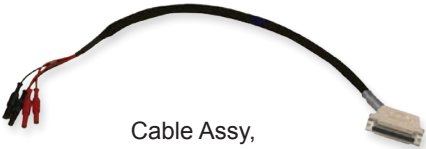
Module Specific Solutions				
VIEW AND DESCRIPTION	END 1	END 2	PART No.	PAGE
 Cable Assy, 4 x 4mm DMM Bayonet Plug to 37 Way D-Type Connector, Female.	4 x 4mm DMM Bayonet Plug	1 x 37 Way D-Type, Female	40-975-037-*m	Page 16

CUSTOM TERMINATION

Page 17

PCB Interfacing - 37 Way D-Type Connector

Standard Voltage

- Male or Female versions available
- PCB mounted
- Ideal for user created termination solutions

Accessory allows a user to create their own PCB based termination solution mounted directly on the front of the product or on the end of a cable. Interfacing PCBs should be designed with suitable clearances for the voltage the application requires.

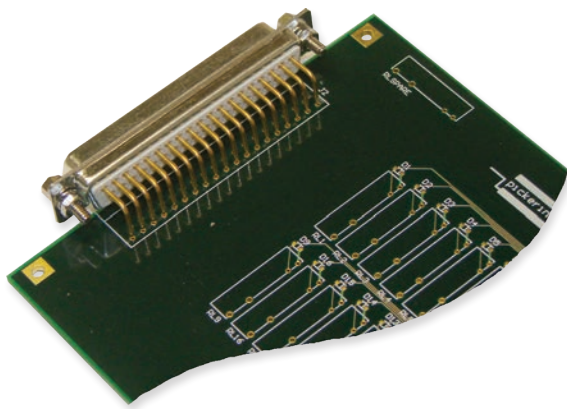
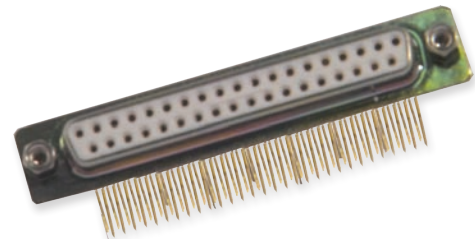

Male Female

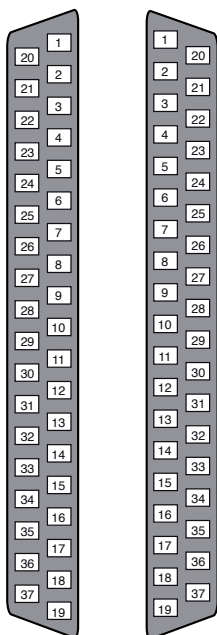

Technical Specification

Connector Type: Gender Mounting Cable Securing Method	37 Way D-Subminiature, Male or Female Right Angle PCB Mount 4-40 UNC Screwlock
Connector Ratings: Current Rating Voltage Rating Contact Material Contact Resistance	5A each pin 250V AC Gold Plated Copper Alloy <20mOhm
Notes:	Female versions are suited to direct connection to a Pickering Module while male versions can be used to interface to a female cable assembly termination

Product Order Codes

37 Way D-Type Connector, 5A, Right Angle PCB Mount
 Female 40-963-037-RF
 Male 40-963-037-RM

PCB Interfacing - 37 Way D Subminiature Connector

Standard Voltage

- Male or Female versions available
- PCB mounted
- Ideal for user created termination solutions

Ideal for user created termination schemes where the termination is to be on the front of the product or remotely connected to the module by cable. Suitable cables for this product are contained elsewhere in this data sheet. Interfacing PCBs should be designed with suitable clearances for the voltage the application requires.

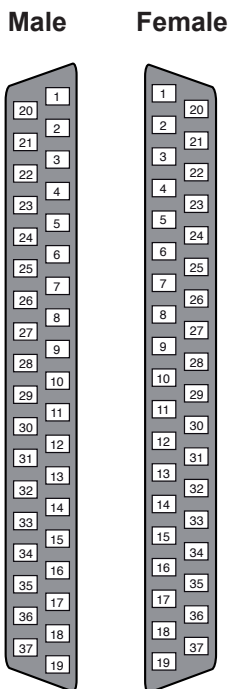
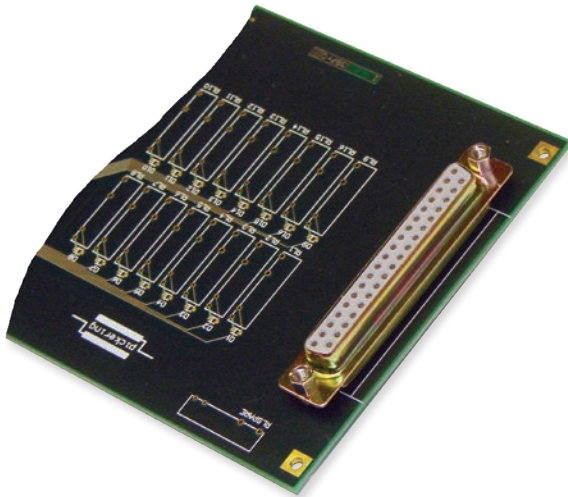
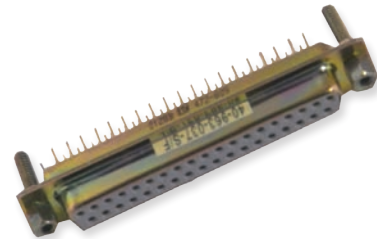

Technical Specification

Connector Type: Gender Mounting Cable Securing Method	37 Way D-Subminiature, Male or Female Straight PCB Mount 4-40 UNC Screwlock
Connector Ratings: Current Rating Voltage Rating Contact Material Contact Resistance	5A each pin 250V AC Gold Plated Copper Alloy <20mOhm
Notes:	Female versions are suited to direct connection to a Pickering Module while male versions can be used to interface to a female cable assembly termination

Product Order Codes

37 Way D-Type Connector, 5A, Straight PCB Mount
Female 40-963-037-SF
Male 40-963-037-SM

Cable Connection - 37 Way D-Type Connector

Standard Voltage

- Connector only or Connector and Backshell
- Soldered connection
- Cable clamp in backshell

This accessory is designed to allow users to directly terminate a cable with soldered connections to the connector.

When the product is used without a backshell users should make their own cable strain relief arrangements and ensure appropriate electrical safety precautions are observed.

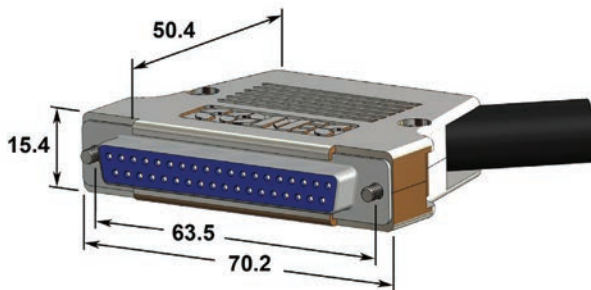
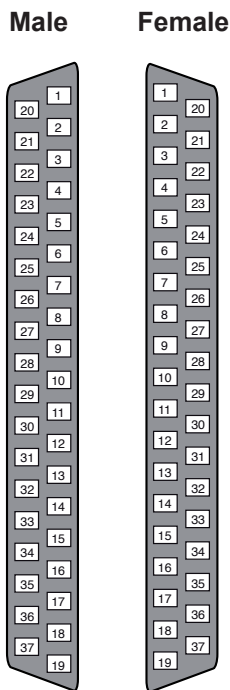

Technical Specification

Connector Type:	37 Way D-Subminiature Connector
Gender	Male or Female
Securing method	4-40 UNC Screwlocks
Cable entry	13mm Dia
Overall size (Approx)	H70 x W15.5 x D55mm
Connector Ratings:	
Current Rating	5A
Voltage Rating	250V AC
Contact Material	Gold Plated Copper Alloy
Contact Resistance	<20mOhm
Cable Connection:	
Recommended Cable	PFA 19/0.15 (0.338mm ² csa, 22AWG), 1.2mm O/D
Connection method	Soldered
Cable Clamp	Yes (In Backshell)
Notes:	37 Way Female cable connectors can be directly mated to a corresponding Pickering Module.

Product Order Codes

37 Way D-Type Connector, 5A, Solder Bucket	
With Backshell, Female	40-960-037-F
With Backshell, Male	40-960-037-M
Without Backshell, Female	92-960-037-F
Without Backshell, Male	92-960-037-M

Direct Connection - 37 Way D-Type Connector Block

Standard Voltage

Connector blocks provide a convenient method of termination without the use of custom cabling. However, a higher resistance path, lower capacity ratings and lower voltage ratings are typical.

- Connector and PCB only or Connector, PCB and Backshell
- Male and Female versions available
- Cable clamp in backshell
- Easy to use rising cage screw terminals

Suitable for use on the front of PXI modules this connector block provides a simple method of connecting to medium density 37 Way D-Type connectors. The screw terminals use a rising cage clamp mechanism to minimize risk of copper strand breakage. PTFE cables are recommended for use with this connector block to maximise copper cross-sectional area and insulation properties. The metal shell includes an internal insulation barrier under the carrier board.

When the product is used without a backshell users should make their own cable strain relief arrangements and ensure appropriate electrical safety precautions are observed.

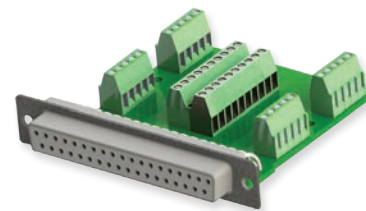

Male Female

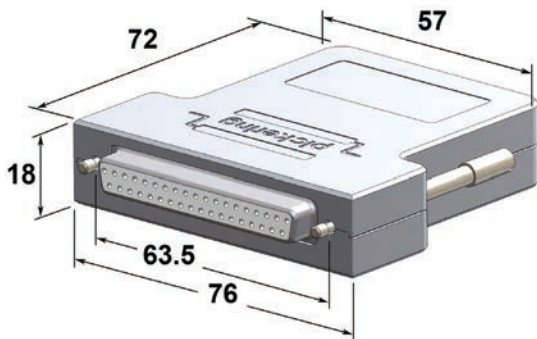
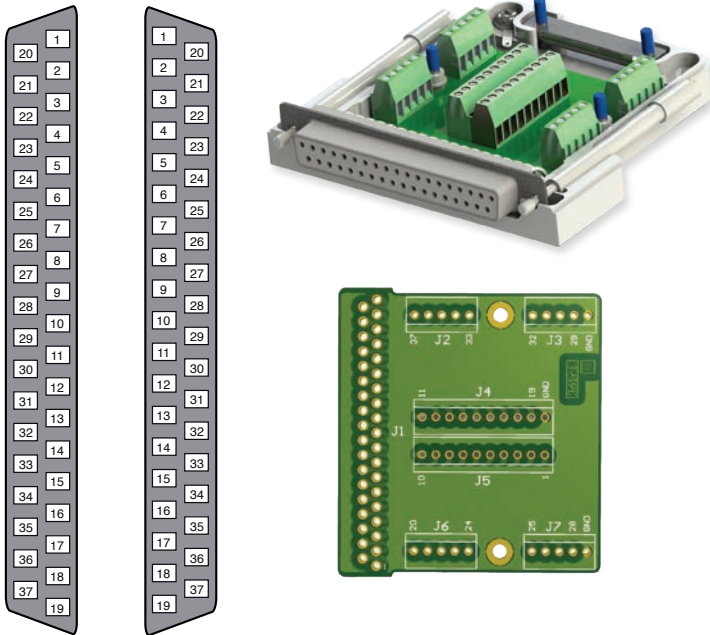

Technical Specification

Connector Block	
Current Rating	5A
Voltage Rating	200V DC
Securing method	4-40 UNC Screwlocks
Cable entry	18 x 24mm
Overall size (Approx)	H76 x W17.5 x D77mm
Main Connector:	
Type	37 Way D-Subminiature
Gender	Male or Female
Current Rating	5A
Voltage Rating	250V AC
Contact Material	Gold Plated Copper Alloy
Contact Resistance	<20mOhm
Wire/Cable Connection:	
Connection method	Rising cage screw terminals
Recommended Wire/Cable	PTFE type
Recommended Wire Size	Up to 0.5mm ² csa
Torque Setting	0.12-0.15Nm
Cable Clamp	Yes (In Backshell)
Notes:	
Female versions are suited to direct connection to a Pickering Module while male versions can be used to interface to a female cable assembly termination	

Product Order Codes

37 Way D-Type Connector Block, 5A, Screw Terminal	
With Backshell, Female	40-965-037-F
With Backshell, Male	40-965-037-M
Without Backshell, Female	92-965-037-F
Without Backshell, Male	92-965-037-M

Cable Connection - 37 Way D-Type Breakout

Standard Voltage

Connector blocks provide a convenient method of termination without the use of custom cabling. However, a higher resistance path, lower capacity ratings and lower voltage ratings are typical.

- For connection at cable end
- Simple to use rising cage screw clamp termination
- DIN Rail Mounted

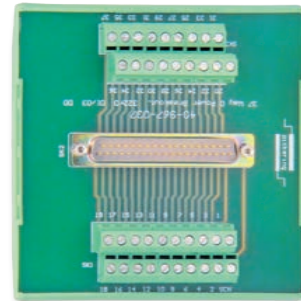
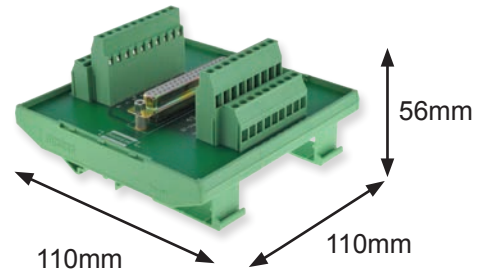

Suitable for use at the end of mating cable remote from the product and on DIN rails this termination option is capable of accepting heavy duty connection wires and uses rising clamp screw terminals to minimize the danger of copper strand damage.

Users should care take to protect the termination, provide a suitable method of restraining the cables, and ensure appropriate electrical safety precautions are observed.



40-967-037-M

Male

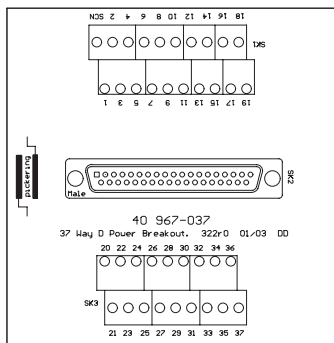
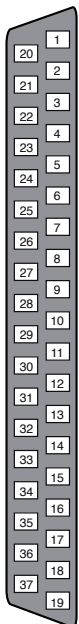

Female

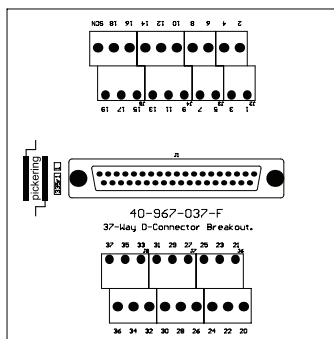

40-967-037-F

Technical Specification

Connector Block	
Current Rating	5A
Voltage Rating	200V DC
Securing method	Suitable for securing to DIN rails.
Overall size (Approx)	H110 x W110 x D56mm
Main Connector:	
Type	37 Way D-Subminiature
Gender	Male or Female
Current Rating	5A
Voltage Rating	250V AC
Contact Material	Gold Plated Copper Alloy
Contact Resistance	<20mOhm
Cable Securing Method	4-40 UNC Screwlocks
Wire/Cable Connection:	
Connection method	Rising cage screw terminals
Recommended Wire/Cable	Any (User Defined)
Recommended Wire Size	Solid wire up to 4mm ² csa
Torque Setting	0.5-0.6Nm
Cable Clamp	No
Notes:	
	Female versions are suited to direct connection to a Pickering Module while male versions can be used to interface to a female cable assembly termination.

Product Order Codes

37 Way D-Type Breakout with DIN Rail Mount, 5A, Screw Terminal, Female **40-967-037-F**
 37 Way D-Type Breakout with DIN Rail Mount, 5A, Screw Terminal, Male **40-967-037-M**

37 Way D-Type Connector to Connector Assembly

Standard Voltage

- High Specification Cable
- Highly Flexible Cable
- Strain Relief
- Braided sleeving
- Fully screened cable construction



A 37 Way Female connector option of this cable assembly is suited for direct connection to Pickering Interfaces products.

Technical Specification

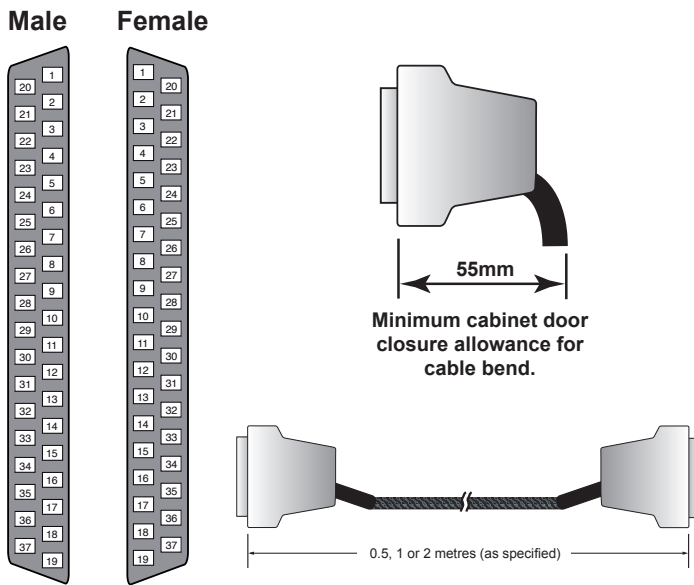

Cable Assembly Rating: Maximum Current Maximum Voltage Standard Lengths Door Closure Allowance	5A 250VAC / 400VDC Multiples of 0.5m 55mm (See diagram)
Connector Type (End A): Gender Current Rating Voltage Rating Contact Material Contact Resistance Product Securing method Overall size (Approx)	37 Way D-Subminiature Male or Female 5A 250V AC Gold Plated Copper Alloy <20mOhm 4-40 UNC Screwlocks H70 x W15.5 x D55mm
Connector Type (End B): Gender	As End A Male or Female
Cable Type: Conductors: Material Strands Resistance Screened Construction Insulation Outer Sleeve Additional Braided Sleeve Cable O/D Minimum Bend Radius	Tinned Copper Wire 19/0.18 (0.410mm ² , 21AWG) 0.041Ω/m (max) Yes PFA Polyester Yes 10mm 25mm
Notes:	Other cable lengths can be supplied.

Characteristic Plots for 40-970-037-1m

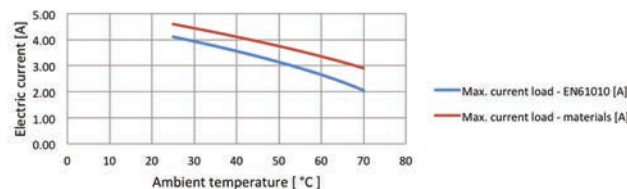
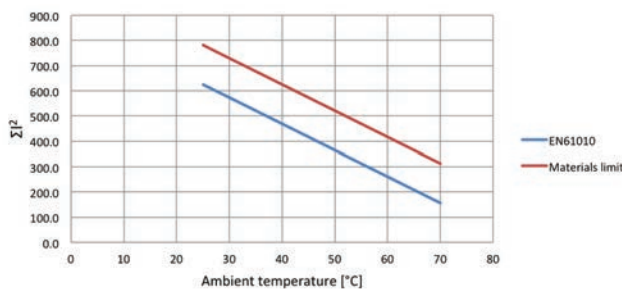

Top graph shows the permitted ΣI^2 versus ambient temperature in accordance with EN61010 for user exposure to surface temperature and a higher limit imposed by the materials used where the cable is not directly user accessible.

Bottom graph shows allowed current versus temperature assuming ALL wires carry the same current. Higher currents to the cable rating are permitted on individual wires provided the ΣI^2 is complied with.

Product Order Codes

37 Way D-Type Cable Assy, 5A, Female to Female	
0.5m Long	40-970-037-0.5m-FF
1.0m Long	40-970-037-1m-FF
2.0m Long	40-970-037-2m-FF
37 Way D-Type Cable Assy, 5A, Male to Male	
0.5m Long	40-970-037-0.5m-MM
1.0m Long	40-970-037-1m-MM
2.0m Long	40-970-037-2m-MM
37 Way D-Type Cable Assy, 5A, Male to Female	
0.5m Long	40-970-037-0.5m-MF
1.0m Long	40-970-037-1m-MF
2.0m Long	40-970-037-2m-MF

37 Way D-Type Connector to Unterminated

Standard Voltage

- High Specification Cable
- Highly Flexible Cable
- Fully screened cable construction with Braided Sleeve and Strain Relief
- Fully coded markers to ensure easy connection
- Boot lace ferrules to prevent wire strand breakage



The cable assembly comprises a 37 pin D-Type connector with unterminated connections at the other end. The unterminated connections are coded to match the connector pin designation and include crimped on ferrules to ensure the wire strands cannot break when they are terminated. Please ensure appropriate electrical safety precautions are observed.

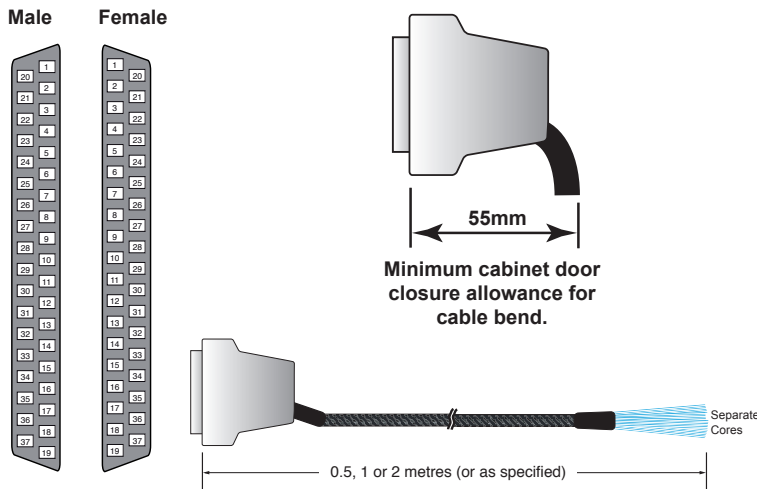

Technical Specification

Cable Assembly Rating:	
Maximum Current	5A
Maximum Voltage	250VAC / 400VDC
Standard Lengths	Multiples of 0.5m
Door Closure Allowance	55mm (See diagram)
Connector Type (End A):	
Gender	37 Way D-Subminiature Male or Female
Current Rating	5A
Voltage Rating	250V AC
Contact Material	Gold Plated Copper Alloy
Contact Resistance	<20mOhm
Product Securing method	4-40 UNC Screwlocks
Overall size (Approx)	H70 x W15.5 x D55mm
Unterminated End (End B)	
Wire coding	Yes - To Connector pins
Boot Lace Ferrules	Yes
Contact Material/Fixing	Tinned Copper/Crimped
Free wire length	130mm nominal
Cable Type:	
Conductors:	
Material	Tinned Copper Wire
Strands	19/0.18 (0.410mm ² , 21AWG)
Resistance	0.041Ω/m (max)
Screened Construction	Yes
Insulation	PFA
Outer Sleeve	Polyester
Additional Braided Sleeve	Yes
Cable O/D	10mm
Minimum Bend Radius	25mm
Notes:	
	<ul style="list-style-type: none"> • 37 Way Female cable connectors can be directly mated to a corresponding Pickering Module. • Other cable lengths can be supplied.

Characteristic Plots for 40-972-037-1m

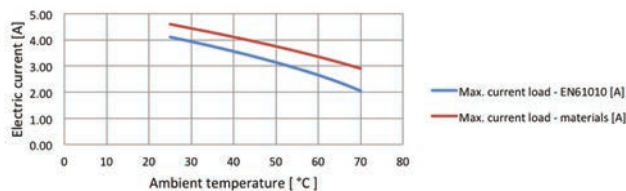
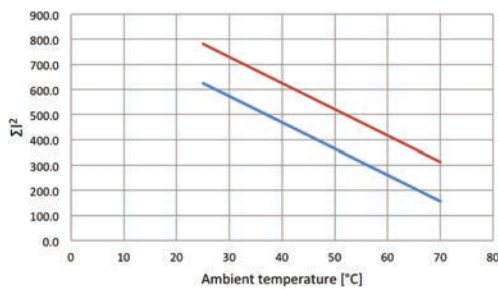

Top graph shows the permitted ΣI^2 versus ambient temperature in accordance with EN61010 for user exposure to surface temperature and a higher limit imposed by the materials used where the cable is not directly user accessible.

Bottom graph shows allowed current versus temperature assuming ALL wires carry the same current. Higher currents to the cable rating are permitted on individual wires provided the ΣI^2 is complied with.

Product Order Codes

37 Way D-Type Cable Assy, 5A, Female to Unterminated

0.5m Long	40-972-037-0.5m-FU
1.0m Long	40-972-037-1m-FU
2.0m Long	40-972-037-2m-FU

37 Way D-Type Cable Assy, 5A, Male to Unterminated

0.5m Long	40-972-037-0.5m-MU
1.0m Long	40-972-037-1m-MU
2.0m Long	40-972-037-2m-MU

PCB Interfacing - 37 Way D-Type Connector

High Voltage

- Male or Female versions available
- PCB mounted
- Ideal for user created termination solutions

Accessory allows a user to create their own PCB based termination solution mounted directly on the front of the product or on the end of a cable. Interfacing PCBs should be designed with suitable clearances for the voltage the application requires.

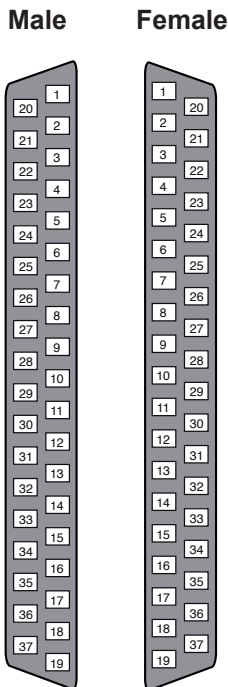
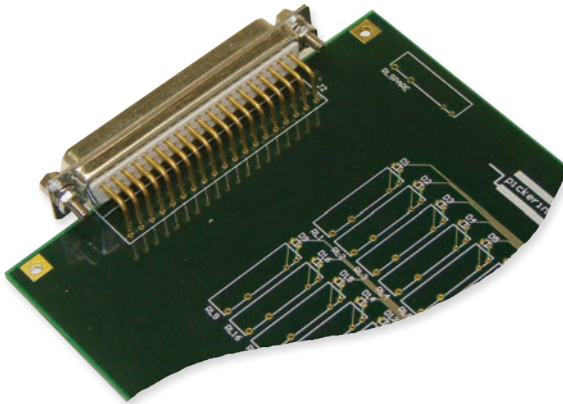
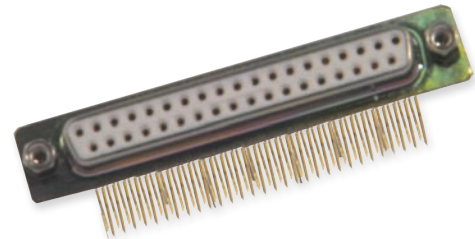

Technical Specification

Connector Type: Gender Mounting Cable Securing Method	37 Way D-Subminiature, Male or Female Right Angle PCB Mount 4-40 UNC Screwlock
Connector Ratings: Current Rating Voltage Rating Contact Material Contact Resistance	5A each pin 1000V DC or AC Gold Plated Copper Alloy <20mOhm
Notes:	Female versions are suited to direct connection to a Pickering Module while male versions can be used to interface to a female cable assembly termination.

Product Order Codes

37 Way D-Type Connector, 5A, Right Angle PCB Mount
 Female 40-963-037-RF-HV
 Male 40-963-037-RM-HV

PCB Interfacing - 37 Way D Subminiature Connector

High Voltage

- Male or Female versions available
- PCB mounted
- Ideal for user created termination solutions

Ideal for user created termination schemes where the termination is to be on the front of the product or remotely connected to the module by cable. Suitable cables for this product are contained elsewhere in this data sheet. Interfacing PCBs should be designed with suitable clearances for the voltage the application requires.

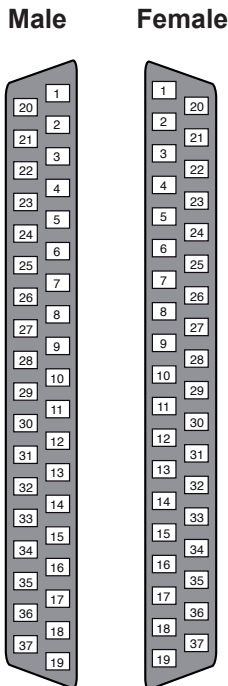
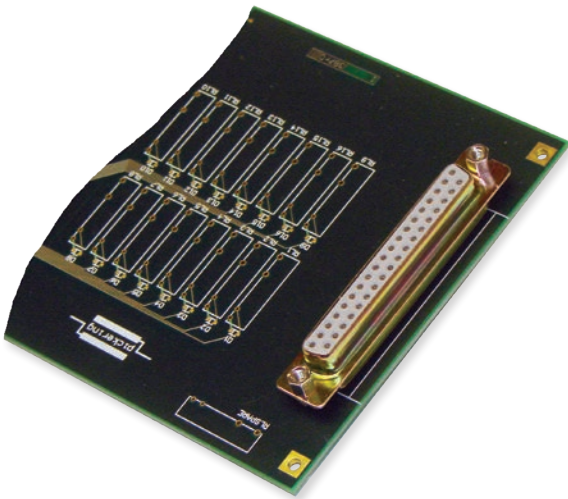
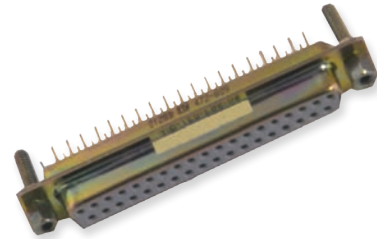

Technical Specification

Connector Type: Gender Mounting Cable Securing Method	37 Way D-Subminiature, Male or Female Straight PCB Mount 4-40 UNC Screwlock
Connector Ratings: Current Rating Voltage Rating Contact Material Contact Resistance	5A each pin 1000V DC or AC Gold Plated Copper Alloy <20mOhm
Notes:	Female versions are suited to direct connection to a Pickering Module while male versions can be used to interface to a female cable assembly termination.

Product Order Codes

37 Way D-Type Connector, 5A, Straight PCB Mount
Female 40-963-037-SF-HV
Male 40-963-037-SM-HV

Cable Connection - 37 Way D-Type Connector

High Voltage

- Connector only
- Soldered connection
- Cable clamp in backshell

This accessory is designed to allow users to directly terminate a cable with soldered connections. When the product is used without a backshell users should make their own cable strain relief arrangements and ensure appropriate electrical safety precautions are observed.

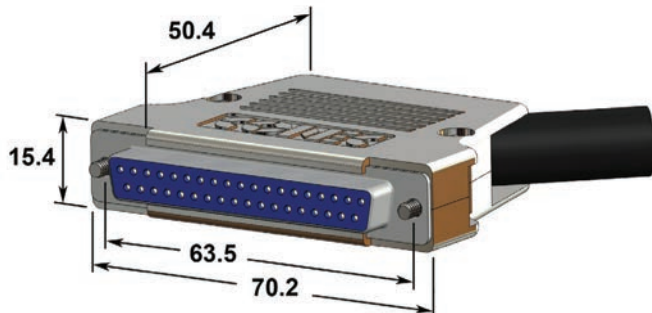
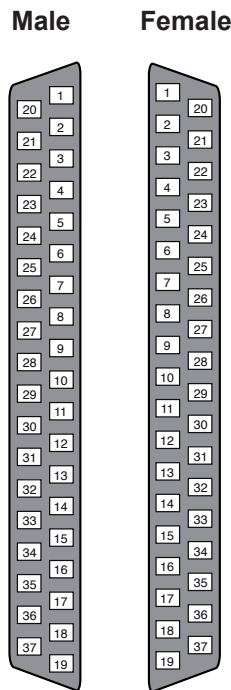

Technical Specification

Connector Type:	37 Way D-Subminiature High Voltage
Gender	Male or Female
Securing method	4-40 UNC Screwlocks
Cable entry	12mm Dia
Overall size (Approx)	H70 x W15.5 x D55mm
Connector Ratings:	
Current Rating	5A
Voltage Rating	1000V DC or AC
Contact Material	Gold Plated Copper Alloy
Contact Resistance	<20mOhm
Cable Connection:	
Recommended Cable	PTFE Type C - 7/0.2mm (0.22mm ² csa, 24AWG) 1.62mm O/D
Connection method	Soldered
Cable Clamp	Yes (In Backshell)
Notes:	Female versions are suited to direct connection to a Pickering Module while male versions can be used to interface to a female cable assembly termination.

Product Order Codes

- 37 Way D-Type Connector, 5A, Solder Bucket, With Backshell, Female, High Voltage 40-960-037-F-HV
- With Backshell, Male, High Voltage 40-960-037-M-HV
- Without Backshell, Female, High Voltage 92-960-037-F-HV
- Without Backshell, Male, High Voltage 92-960-037-M-HV

37 Way D-Type Connector to Connector Assembly

High Voltage

- High Specification Cable
- Highly Flexible Cable
- Strain Relief
- Braided sleeving
- Fully screened cable construction



A 37 Way Female connector option of this cable assembly is suited for direct connection to a corresponding Pickering product.

Technical Specification

Cable Assembly Rating:	
Maximum Current	5A
Maximum Voltage	750V Working/1000VDC AC Peak typical
Standard Lengths	Multiples of 0.5m
Door Closure Allowance	55mm (See diagram)
Connector Type (End A):	
Gender	37 Way D-Subminiature, HV Male or Female
Current Rating	5A
Voltage Rating	1000V DC or AC
Contact Material	Gold Plated Copper Alloy
Contact Resistance	<20mOhm
Product Securing method	4-40 UNC Screwlocks
Overall size (Approx)	H70 x W15.5 x D55mm
Connector Type (End B)	
Gender	As End A Male or Female
Cable Type:	
Conductors:	
Material	Tinned Copper Wire
Strands	7/0.2 (0.22 mm ² 24AWG) 1.62mm O/D
Resistance	0.089Ω/m (max) at 20°C
Screened Construction	Yes
Insulation	PTFE Type C (BS3G210)
Outer Sleeve	Polyester
Additional Braided Sleeve	Yes
Cable O/D	12mm
Minimum Bend Radius	25mm
Notes:	
Other cable lengths can be supplied.	

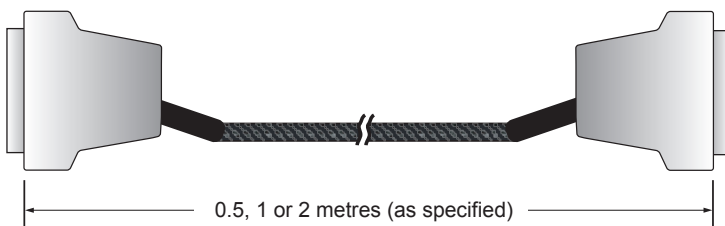
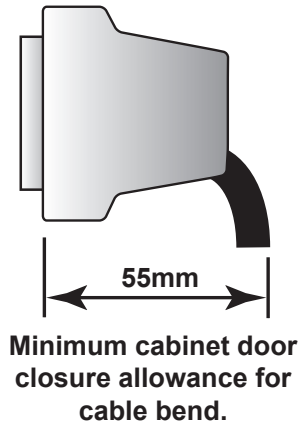
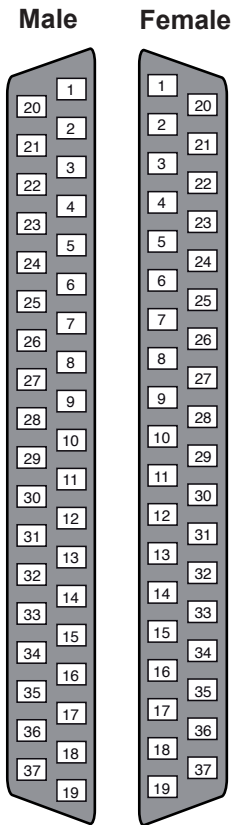

Product Order Codes

37 Way D-Type Cable Assy, 5A, Female to Female, HV	
0.5m Long	40-970-037-0.5m-FF-HV
1.0m Long	40-970-037-1m-FF-HV
2.0m Long	40-970-037-2m-FF-HV
37 Way D-Type Cable Assy, 5A, Male to Male, HV	
0.5m Long	40-970-037-0.5m-MM-HV
1.0m Long	40-970-037-1m-MM-HV
2.0m Long	40-970-037-2m-MM-HV
37 Way D-Type Cable Assy, 5A, Male to Female, HV	
0.5m Long	40-970-037-0.5m-MF-HV
1.0m Long	40-970-037-1m-MF-HV
2.0m Long	40-970-037-2m-MF-HV

37 Way D-Type Connector to Unterminated

High Voltage

- High Specification Cable
- Highly Flexible Cable
- Fully screened cable construction with Braided Sleeve and Strain Relief
- Fully coded markers to ensure easy connection
- Boot lace ferrules to prevent wire strand breakage



A range of 37 Way D-Type High Voltage cable assemblies with unterminated connections on one end. The unterminated connections are coded to match the connector pin designation and include crimped on ferrules to ensure the wire strands cannot break when they are terminated. Please ensure appropriate electrical safety precautions are observed.

Technical Specification

Cable Assembly Rating: Maximum Current Maximum Voltage	5A 750V Working/1000VDC AC Peak typical
Standard Lengths Door Closure Allowance	Multiples of 0.5m 55mm (See diagram)
Connector Type (End A): Gender Current Rating Voltage Rating Contact Material Contact Resistance Product Securing method Overall size (Approx)	37 Way D-Subminiature, HV Male or Female 5A 1000V DC or AC Gold Plated Copper Alloy <20mOhm 4-40 UNC Screwlocks H70 x W15.5 x D55mm
Unterminated End (End B) Wire coding Boot Lace Ferrules Contact Material/Fixing Free wire length	Yes - To Connector pins Yes Tinned Copper/Crimped 130mm nominal
Cable Type: Conductors: Material Strands Resistance Screened Construction Insulation Outer Sleeve Additional Braided Sleeve Cable O/D Minimum Bend Radius	Tinned Copper Wire 7/0.2 (0.22 mm ² 24AWG) 1.62mm O/D 0.089Ω/m (max) at 20°C Yes PTFE Type C (BS3G210) Polyester Yes 12mm 25mm
Notes:	<ul style="list-style-type: none"> • 37 Way Female cable connectors can be directly mated to a corresponding Pickering Module. • Other cable lengths can be supplied.

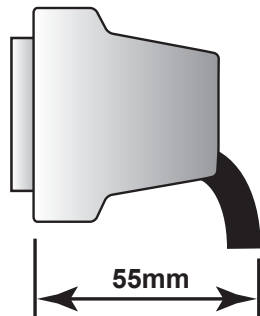
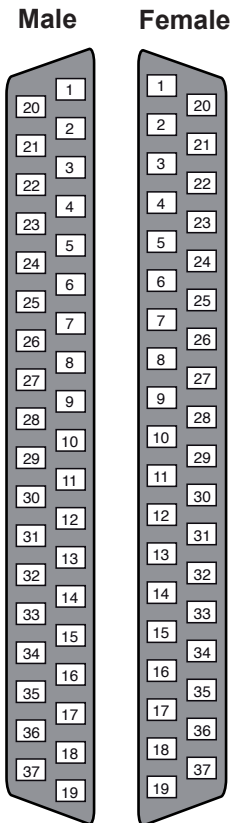

Minimum cabinet door closure allowance for cable bend.

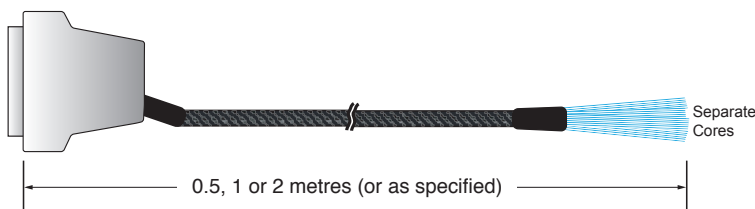

Product Order Codes

37 Way D-Type Cable Assy, 5A, Female to Unterminated	
0.5m Long, High Voltage	40-972-037-0.5m-FU-HV
1.0m Long, High Voltage	40-972-037-1m-FU-HV
2.0m Long, High Voltage	40-972-037-2m-FU-HV
37 Way D-Type Cable Assy, 5A, Male to Unterminated	
0.5m Long, High Voltage	40-972-037-0.5m-MU-HV
1.0m Long, High Voltage	40-972-037-1m-MU-HV
2.0m Long, High Voltage	40-972-037-2m-MU-HV

Calibration Port Precision Resistor Modules

Module Specific

- High Specification Cable
- Stranded Hi-Flex PVC Cable
- Strain Relief
- Braided sleeving
- Fully screened cable construction



The calibration cable assembly is specifically designed to connect to the 37-Way D-Type port located on the front panel of Pickering Interfaces Precision Programmable Resistor Module 40-297 enabling calibration via an external DMM.

Technical Specification

Cable Assembly Rating:	
Maximum Current	5A
Maximum Voltage	750V
Standard Lengths	1.0m
Door Closure Allowance	55mm (See diagram)
Connector Type (End A):	4 x 4mm DMM Bayonet Plug
Gender	Male
Current Rating	32A
Voltage Rating	1000V
Contact Material	Gold Plated Copper Alloy
Contact Resistance	<20mOhm
Product Securing method	Push fit
Overall size (Approx)	50 x 8.5mm Dia
Connector Type (Ends B)	37 Way D-Subminiature
Gender	Male or Female
Current Rating	5A
Voltage Rating	250V AC
Contact Material	Gold Plated Copper Alloy
Contact Resistance	<20mOhm
Product Securing method	4-40 UNC Screwlocks
Overall size (Approx)	H70 x W15.5 x D55mm
Cable Type:	Stranded Hi-Flex PVC
Conductors:	
Material	Tinned Copper Wire
Strands	259/0.07 (1.0 mm ² 17AWG)
	2.7mm O/D (inc insulation)
Screened Construction	No
Insulation	PVC
Outer Sleeve	Polyester
Additional Braided Sleeve	Yes
Cable O/D	8mm
Minimum Bend Radius	10mm
Notes:	Other cable lengths can be supplied.

Female

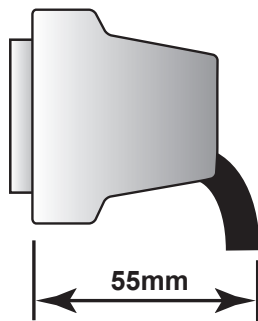
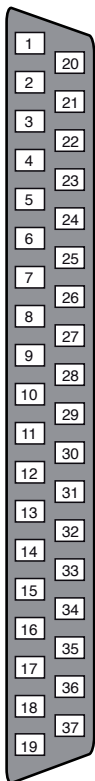

Minimum cabinet door closure allowance for cable bend.

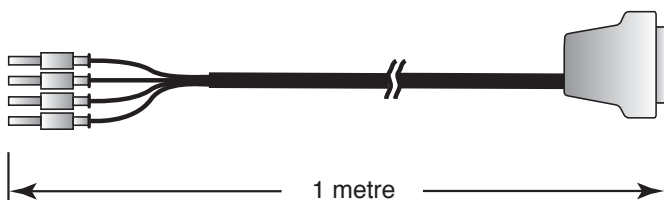

Product Order Codes

4 x 4mm DMM Bayonet Plug to 37 Way D-Type connector, Female
40-975-037-1m

Custom Termination

Pickering Interfaces is able to manufacture custom built cable assemblies and backshells that mate with all the connectors we use in our extensive product range.

We are able to manufacture cable assemblies and other termination arrangements to user drawings and deal with both small volume orders and high volume orders.

All products are designed to ensure easy and problem free connection to our products and we can provide solutions to connect to third party products.

We offer a fast turn round of custom parts to keep your product ordering and integration timescales to a minimum.

