

Current-compensated Chokes



- Rated currents from 0.3 to 10 A
- DC to 400 Hz frequency
- 100 kHz to 3 MHz common-mode resonance frequency
- Dual-choke configurations
- Multiple PCB-mounting options



Performance indicators

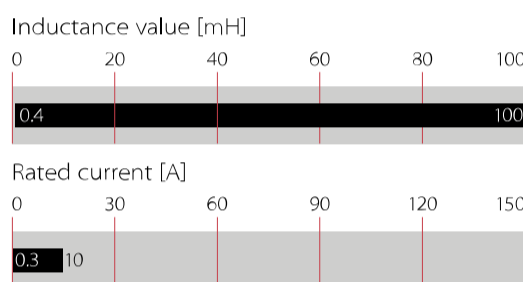

Technical Specifications

Nominal operating voltage	300 VAC
Rated currents	0.3 to 10 A @ 40°C
Operating frequency	DC to 400 Hz
Rated inductance	0.4 to 100 mH
Stray inductance	Typically 1% of L _n
Inductance reduction (DC bias with I_N)	Less than 10% (25°C)
Surge current @ 10 msec	20 x nominal current @ 25°C
Temperature range (operation and storage)	-40°C to 100°C (40/100/56) acc. IEC 60068-1
High potential test voltage winding-to-winding @ 25°C	1500 VAC, 60 sec, guaranteed 1500 VAC, 2 sec, factory test
Winding-to-housing @ 25°C	Winding-to-housing @ 25°C
Flammability corresponding to	Housing UL 94V-0 Potting compound UL 94V-0
Design corresponding to	UL 1283, IEC/EN 60938-1
MTBF (Mil-HB-217F)	>5,000,000 h @ 40°C/230 V

Approvals & Compliances



RN chokes are attenuating common-mode or asymmetric (P/N > E) interference signals, by being connected in series with the phase and neutral lines of an AC powerline input. Symmetrical components of the noise are also attenuated by the leakage inductance (stray inductance) of the windings. These chokes are typically used in conjunction with suppression capacitors.

Features and Benefits

- High saturation resistance and excellent thermal behavior
- Through hole pin connections
- Dual-choke configuration
- Small compact design
- Multiple housing options
- Custom-specific versions are available on request
- Higher temperature versions
- Fully potted design usable for ruggedized applications







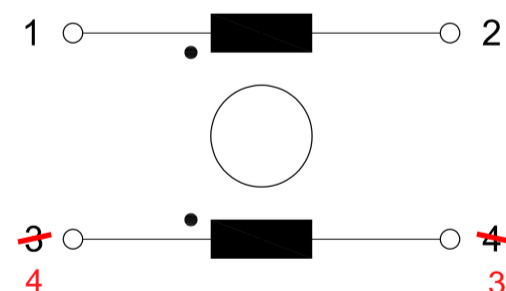













































Typical Applications



















































- Switch-mode power applications
- Suppressing common-mode interference levels
- EMI input filters
- For suppression-equipment with no earth connection

Typical electrical schematic



Choke Selection Table

Choke	Buy	Current (In) [A]	@ ambient temperature [°C]	Inductance (LN) [mH]	Resistance (Rdc) [mOhm]	A [mm]	B [mm]	H [mm]	Weight (g)
RN102-0.3-02-22M		0.3	40	22.0	1300	10.0	10.0	9.0	4
RN102-0.3-02-12M		0.3	40	12.0	1100	10.0	10.0	9.0	3
RN102-0.6-02-4M4		0.6	40	4.4	380	10.0	10.0	9.0	3
RN102-1-02-3M0		1.0	40	3.0	210	10.0	10.0	9.0	3
RN102-1.5-02-1M6		1.5	40	1.6	94	10.0	10.0	9.0	3
RN102-2-02-1M1		2.0	40	1.1	70	10.0	10.0	9.0	3
RN112-0.4-02-39M		0.4	40	39.0	1500	15.0	10.0	12.6	6
RN112-0.4-02-27M		0.4	40	27.0	1400	15.0	10.0	12.6	6
RN112-0.5-02-27M		0.5	40	27.0	1200	15.0	10.0	12.6	6
RN112-0.5-02-18M		0.5	40	18.0	1100	15.0	10.0	12.6	6
RN112-0.5-02-15M		0.5	40	15.0	700	15.0	10.0	12.6	6
RN112-0.6-02-15M		0.6	40	15.0	490	15.0	10.0	12.6	6
RN112-0.8-02-10M		0.8	40	10.0	380	15.0	10.0	12.6	6
RN112-1.2-02-6M8		1.2	40	6.8	250	15.0	10.0	12.6	6
RN112-1.5-02-3M3		1.5	40	3.3	102	15.0	10.0	12.6	6
RN112-2-02-1M8		2.0	40	1.8	74	15.0	10.0	12.6	6
RN112-2-02-1M0		2.0	40	1.0	70	15.0	10.0	12.6	6
RN112-2.6-02-0M4		2.6	40	0.4	40	15.0	10.0	12.6	6
RN112-3.6-02-0M4		3.6	40	0.4	27	15.0	10.0	12.6	6
RN112-4-02-0M7		4.0	40	0.7	24	15.0	10.0	12.6	6
RN114-0.3-02-47M		0.3	40	47.0	1700	20.1	12.5	13.2	10
RN114-0.5-02-39M		0.5	40	39.0	830	20.1	12.5	13.2	11
RN114-0.8-02-27M		0.8	40	27.0	500	20.1	12.5	13.2	11
RN114-1-02-15M		1.0	40	15.0	370	20.1	12.5	13.2	10
RN114-1.2-02-10M		1.2	40	10.0	195	20.1	12.5	13.2	10
RN114-1.5-02-6M8		1.5	40	6.8	123	20.1	12.5	13.2	11
RN114-2-02-4M2		2.0	40	4.2	100	20.1	12.5	13.2	11
RN114-2.5-02-3M3		2.5	40	3.3	72	20.1	12.5	13.2	11
RN114-3-02-2M0		3.0	40	2.0	52	20.1	12.5	13.2	10
RN114-4-02-1M5		4.0	40	1.5	34	20.1	12.5	13.2	11
RN116-0.5-02-47M		0.5	60	47.0	960	20.1	12.5	13.2	11
RN116-0.5-02-39M		0.5	60	39.0	920	20.1	12.5	13.2	11
RN116-0.5-02-27M		0.5	60	27.0	790	20.1	12.5	13.2	11
RN116-0.8-02-27M		0.8	60	27.0	370	20.1	12.5	13.2	13
RN116-1-02-15M		1.0	60	15.0	260	20.1	12.5	13.2	12
RN116-1-02-10M		1.0	60	10.0	210	20.1	12.5	13.2	11
RN116-1.3-02-6M8		1.3	60	6.8	140	20.1	12.5	13.2	12
RN116-1.5-02-10M		1.5	60	10.0	148	20.1	12.5	13.2	12
RN116-1.7-02-4M0		1.7	60	4.0	87	20.1	12.5	13.2	12
RN116-2-02-3M3		2.0	60	3.3	70	20.1	12.5	13.2	12
RN116-2-02-2M2		2.0	60	2.2	66	20.1	12.5	13.2	11
RN122-0.5-02-56M		0.5	40	56.0	1800	25.0	15.0	16.5	20
RN122-0.6-02-47M		0.6	40	47.0	1300	25.0	15.0	16.5	20
RN122-0.8-02-39M		0.8	40	39.0	1000	25.0	15.0	16.5	20
RN122-1-02-18M		1.0	40	18.0	630	25.0	15.0	16.5	19
RN122-1-02-10M		1.0	40	10.0	560	25.0	15.0	16.5	19
RN122-1.5-02-10M		1.5	40	10.0	250	25.0	15.0	16.5	20
RN122-2-02-6M8		2.0	40	6.8	156	25.0	15.0	16.5	20
RN122-2-02-5M0		2.0	40	5.0	140	25.0	15.0	16.5	21
RN122-2.5-02-5M6		2.5	40	5.6	110	25.0	15.0	16.5	20
RN122-3-02-4M5		3.0	40	4.5	80	25.0	15.0	16.5	21
RN122-4-02-3M3		4.0	40	3.3	46	25.0	15.0	16.5	22
RN122-4-02-1M8		4.0	40	1.8	42	25.0	15.0	16.5	22

Choke	Buy	Current (In) [A]	@ ambient temperature [°C]	Inductance (Ln) [mH]	Resistance (R DC) [mOhm]	A [mm]	B [mm]	H [mm]	Weight (g)
RN142-0.5-02-82M		0.5	40	82.0	2700	30.0	20.0	19.7	36
RN142-1-02-33M		1.0	40	33.0	810	30.0	20.0	19.7	37
RN142-1.4-02-27M		1.4	40	27.0	500	30.0	20.0	19.7	40
RN142-2-02-6M8		2.0	40	6.8	192	30.0	20.0	19.7	36
RN142-4-02-3M3		4.0	40	3.3	67	30.0	20.0	19.7	38
RN142-6-02-1M8		6.0	40	1.8	20	30.0	20.0	19.7	40
RN143-0.5-02-100M		0.5	40	100.0	2900	30.0	20.0	19.7	36
RN143-1-02-47M		1.0	40	47.0	890	30.0	20.0	19.7	38
RN143-2-02-10M		2.0	40	10.0	240	30.0	20.0	19.7	42
RN143-4-02-3M9		4.0	40	3.9	59	30.0	20.0	19.7	39
RN143-6-02-1M8		6.0	40	1.8	20	30.0	20.0	19.7	42
RN152-1-02-68M		1.0	40	68.0	1300	40.0	15.0	25.0	75
RN152-2-02-18M		2.0	40	18.0	450	40.0	15.0	25.0	64
RN152-4-02-6M8		4.0	40	6.8	87	40.0	15.0	25.0	74
RN152-6-02-3M9		6.0	40	3.9	42	40.0	15.0	25.0	68
RN152-8-02-2M7		8.0	40	2.7	22	40.0	15.0	25.0	73
RN152-10-02-1M8		10.0	40	1.8	14	40.0	15.0	25.0	73
RN202-0.3-02-22M		0.3	40	22.0	1300	5.1	15.2	13.5	4
RN202-0.3-02-12M		0.3	40	12.0	1100	5.1	15.2	13.5	4
RN202-0.6-02-4M4		0.6	40	4.4	380	5.1	15.2	13.5	4
RN202-1-02-3M0		1.0	40	3.0	210	5.1	15.2	13.5	4
RN202-1.5-02-1M6		1.5	40	1.6	94	5.1	15.2	13.5	4
RN202-2-02-1M1		2.0	40	1.1	70	5.1	15.2	13.5	4
RN204-0.3-02-22M		0.3	40	22.0	1300	7.6	10.0	14.3	3
RN204-0.3-02-12M		0.3	40	12.0	960	7.6	10.0	14.3	3
RN204-0.6-02-4M4		0.6	40	4.4	350	7.6	10.0	14.3	3
RN204-1-02-3M0		1.0	40	3.0	192	7.6	10.0	14.3	3
RN204-1.5-02-1M6		1.5	40	1.6	96	7.6	10.0	14.3	3
RN204-2-02-1M1		2.0	40	1.1	57	7.6	10.0	14.3	3
RN212-0.4-02-39M		0.4	40	39.0	1500	10.0	15.0	20.0	8
RN212-0.4-02-27M		0.4	40	27.0	1400	10.0	15.0	20.0	8
RN212-0.5-02-27M		0.5	40	27.0	1200	10.0	15.0	20.0	8
RN212-0.5-02-18M		0.5	40	18.0	1100	10.0	15.0	20.0	8
RN212-0.5-02-15M		0.5	40	15.0	700	10.0	15.0	20.0	8
RN212-0.6-02-15M		0.6	40	15.0	490	10.0	15.0	20.0	8
RN212-0.8-02-10M		0.8	40	10.0	380	10.0	15.0	20.0	8
RN212-1.2-02-6M8		1.2	40	6.8	250	10.0	15.0	20.0	8
RN212-1.5-02-3M3		1.5	40	3.3	102	10.0	15.0	20.0	8
RN212-2-02-1M8		2.0	40	1.8	74	10.0	15.0	20.0	8
RN212-2-02-1M0		2.0	40	1.0	70	10.0	15.0	20.0	8
RN212-2.6-02-0M4		2.6	40	0.4	40	10.0	15.0	20.0	8
RN212-3.6-02-0M4		3.6	40	0.4	27	10.0	15.0	20.0	8
RN212-4-02-0M7		4.0	40	0.7	24	10.0	15.0	20.0	8
RN214-0.3-02-47M		0.3	40	47.0	1700	12.5	10.0	25.0	14
RN214-0.5-02-56M		0.5	40	56.0	1700	12.5	10.0	25.0	15
RN214-0.5-02-39M		0.5	40	39.0	830	12.5	10.0	25.0	14
RN214-0.8-02-27M		0.8	40	27.0	500	12.5	10.0	25.0	15
RN214-1-02-15M		1.0	40	15.0	370	12.5	10.0	25.0	14
RN214-1.2-02-10M		1.2	40	10.0	195	12.5	10.0	25.0	15
RN214-1.5-02-6M8		1.5	40	6.8	123	12.5	10.0	25.0	15
RN214-2-02-4M2		2.0	40	4.2	100	12.5	10.0	25.0	14

Choke	Buy	Current (In) [A]	@ ambient temperature [°C]	Inductance (Ln) [mH]	Resistance (R DC) [mOhm]	A [mm]	B [mm]	H [mm]	Weight (g)
RN214-2-02-2M2		2.0	40	2.2	67	12.5	10.0	25.0	14
RN214-2.5-02-3M3		2.5	40	3.3	72	12.5	10.0	25.0	15
RN214-3-02-2M0		3.0	40	2.0	52	12.5	10.0	25.0	14
RN214-4-02-1M5		4.0	40	1.5	34	12.5	10.0	25.0	15
RN216-0.5-02-47M		0.5	60	47.0	960	12.5	10.0	25.0	15
RN216-0.5-02-39M		0.5	60	39.0	920	12.5	10.0	25.0	15
RN216-0.5-02-27M		0.5	60	27.0	790	12.5	10.0	25.0	15
RN216-0.8-02-27M		0.8	60	27.0	370	12.5	10.0	25.0	16
RN216-1-02-15M		1.0	60	15.0	260	12.5	10.0	25.0	16
RN216-1-02-10M		1.0	60	10.0	210	12.5	10.0	25.0	15
RN216-1.3-02-6M8		1.3	60	6.8	140	12.5	10.0	25.0	16
RN216-1.5-02-10M		1.5	60	10.0	148	12.5	10.0	25.0	16
RN216-1.7-02-4M0		1.7	60	4.0	87	12.5	10.0	25.0	16
RN216-2-02-3M3		2.0	60	3.3	70	12.5	10.0	25.0	16
RN216-2-02-2M2		2.0	60	2.2	66	12.5	10.0	25.0	15
RN218-0.4-02-100M		0.4	40	100	2800	10.0	12.5	20.0	8
RN218-0.6-02-47M		0.6	40	47.0	1200	10.0	12.5	20.0	8
RN218-0.7-02-39M		0.7	40	39.0	1150	10.0	12.5	20.0	8
RN218-0.9-02-27M		0.9	40	27.0	620	10.0	12.5	20.0	8
RN218-1-02-22M		1.0	40	22.0	520	10.0	12.5	20.0	8
RN218-1.1-02-15M		1.1	40	15.0	420	10.0	12.5	20.0	8
RN218-1.4-02-10M		1.4	40	10.0	330	10.0	12.5	20.0	8
RN218-1.7-02-6M8		1.7	40	6.8	180	10.0	12.5	20.0	8
RN218-2.2-02-3M3		2.2	40	3.3	100	10.0	12.5	20.0	8
RN222-0.5-02-56M		0.5	40	56.0	1800	15.0	12.5	29.3	27
RN222-0.6-02-47M		0.6	40	47.0	1300	15.0	12.5	29.3	26
RN222-0.8-02-39M		0.8	40	39.0	1000	15.0	12.5	29.3	27
RN222-1-02-33M		1.0	40	33.0	1300	15.0	12.5	29.3	29
RN222-1-02-18M		1.0	40	18.0	630	15.0	12.5	29.3	26
RN222-1.5-02-10M		1.5	40	10.0	250	15.0	12.5	29.3	26
RN222-2-02-6M8		2.0	40	6.8	156	15.0	12.5	29.3	28
RN222-2.5-02-5M6		2.5	40	5.6	110	15.0	12.5	29.3	27
RN222-3-02-4M5		3.0	40	4.5	80	15.0	12.5	29.3	28
RN222-4-02-3M3		4.0	40	3.3	46	15.0	12.5	29.3	28
RN232-0.6-02-47M		0.6	40	47.0	1300	15.0	12.5	34.3	37
RN232-1-02-18M		1.0	40	18.0	390	15.0	12.5	34.3	38
RN232-1.6-02-10M		1.6	40	10.0	170	15.0	12.5	34.3	38
RN232-2.5-02-5M6		2.5	40	5.6	86	15.0	12.5	34.3	38
RN232-4-02-3M3		4.0	40	3.3	54	15.0	12.5	34.3	38
RN242-0.5-02-82M		0.5	40	82.0	2700	15.0	12.5	34.3	37
RN242-1-02-33M		1.0	40	33.0	810	15.0	12.5	34.3	38
RN242-1.4-02-27M		1.4	40	27.0	500	15.0	12.5	34.3	38
RN242-2-02-6M8		2.0	40	6.8	192	15.0	12.5	34.3	37
RN242-4-02-3M3		4.0	40	3.3	67	15.0	12.5	34.3	38
RN242-6-02-1M8		6.0	40	1.8	20	15.0	12.5	34.3	41

Test conditions: Measuring frequency: 10 kHz; 50 mV; Inductance tolerance: +50%, -30%; Resistance tolerance: ±15% @ 25°C; Electrical characteristics @ 25°C: ±2°C; Stray Inductance measurement between pin 1 and 2 (pin 3 and 4 shorted)
For mechanical tolerances refer to mechanical data section.

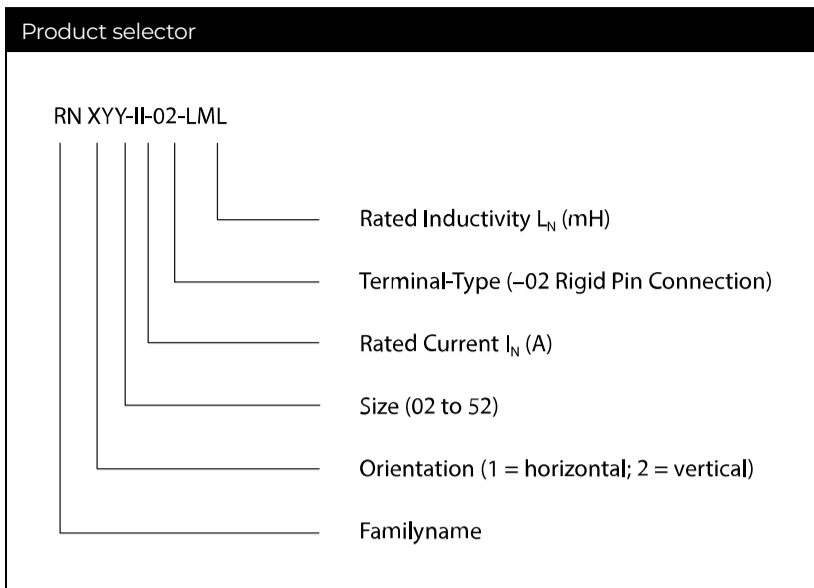

Distribution Inventory

Up-to-date inventory levels for global distributors is available at

<https://products.schaffner.com/stock>



Thermal Derating

If higher ambient temperatures than the specified apply, the nominal current needs to be reduced according to the graph below.

Graph on the left side applies to RN with rated ambient temperature of 40 °C, right side for rated ambient temperature of 60 °C.

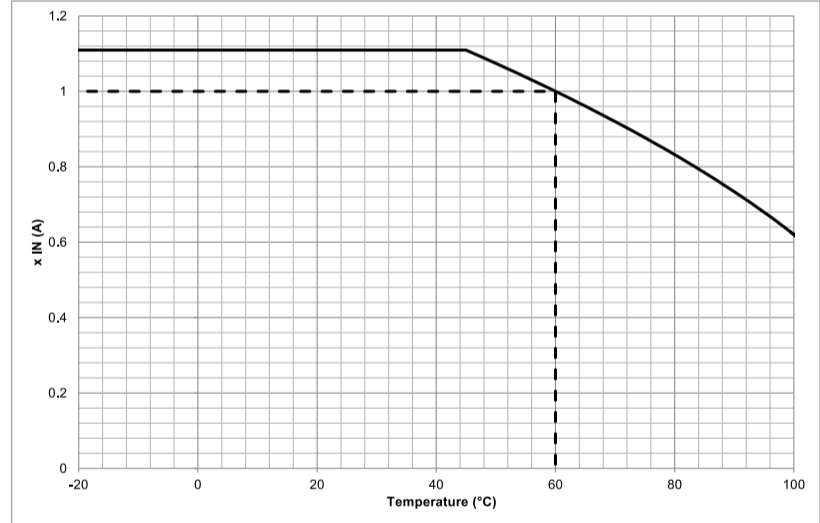
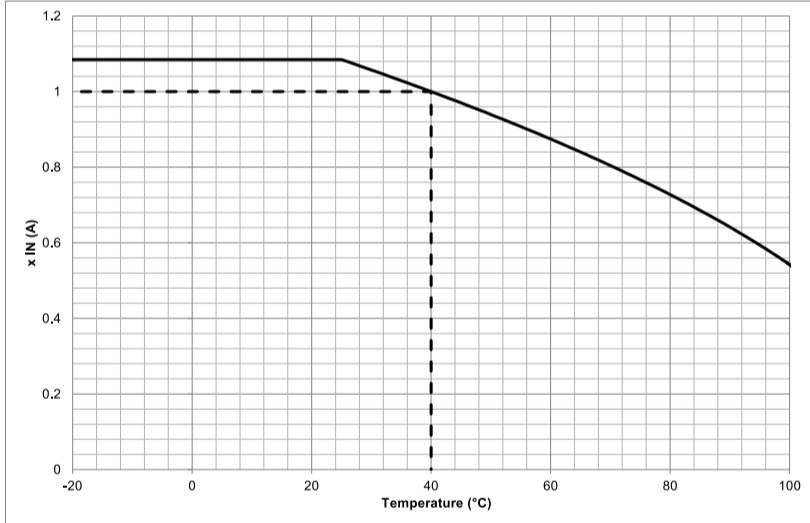

Typical Attenuation/Resonance Frequency Characteristics

Per CISPR 17; 50 Ω/50 Ω asym

X can be exchanged with either 1 or 2 for different housing configuration, attenuation is similar

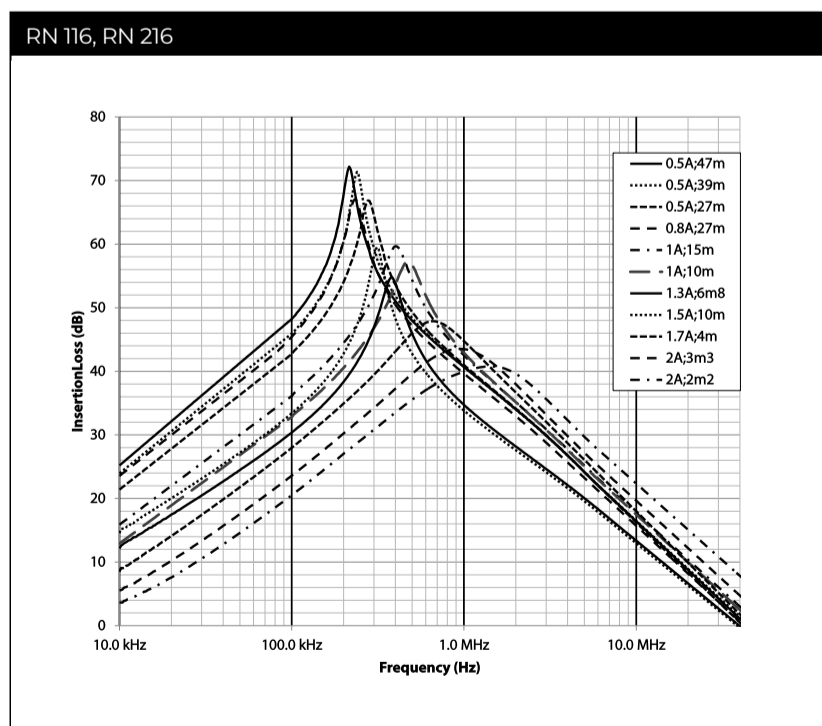
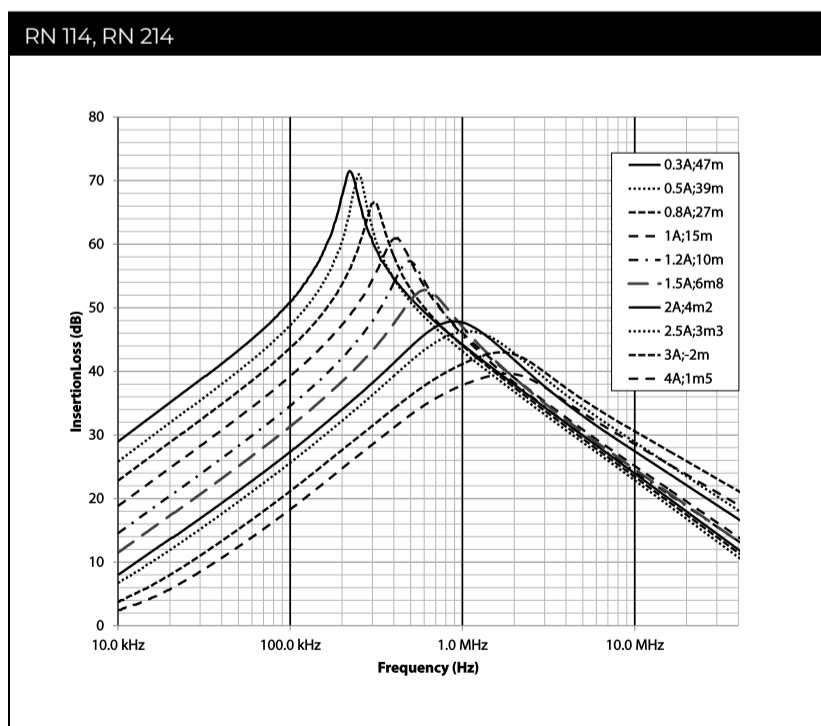
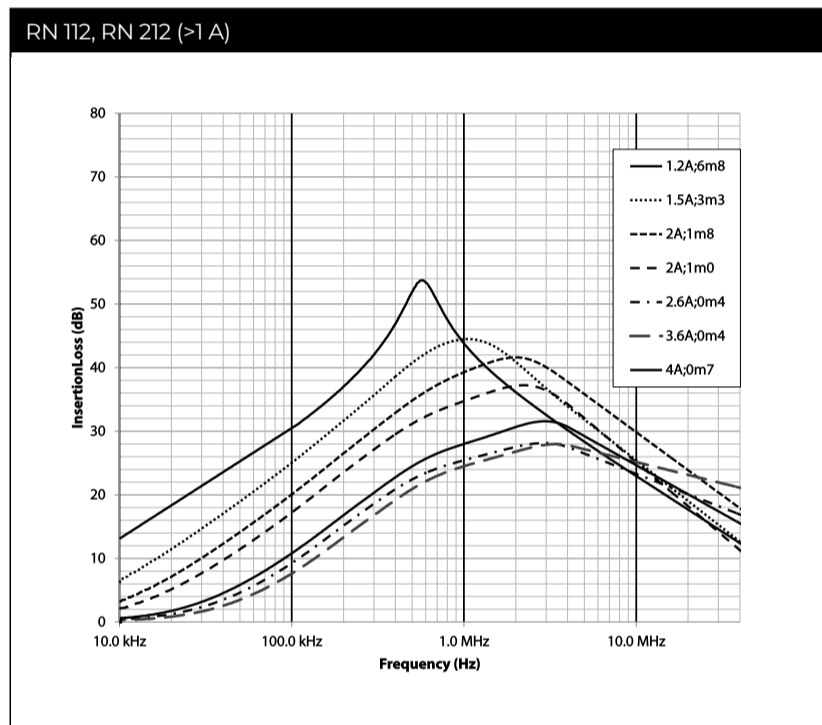
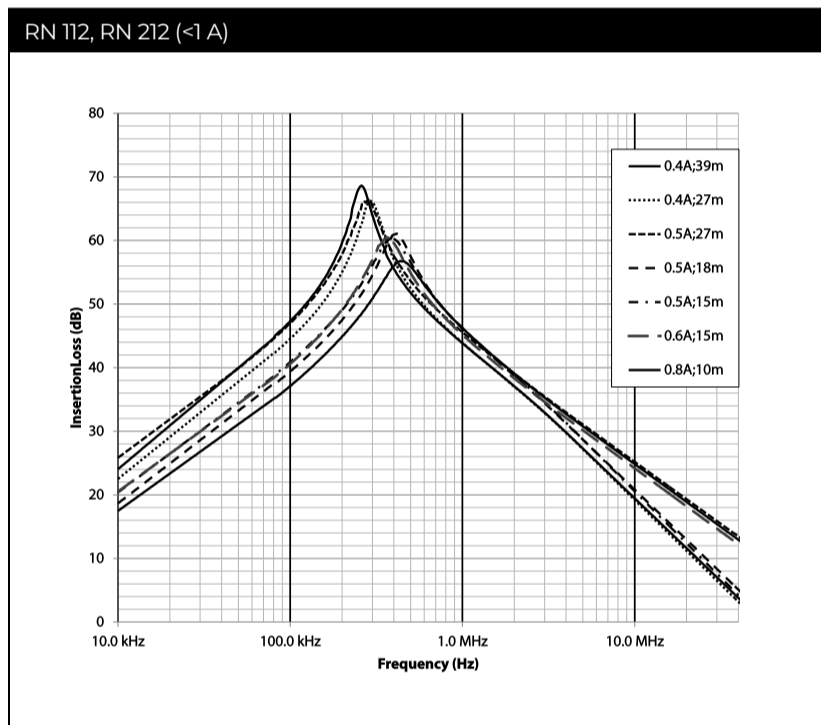
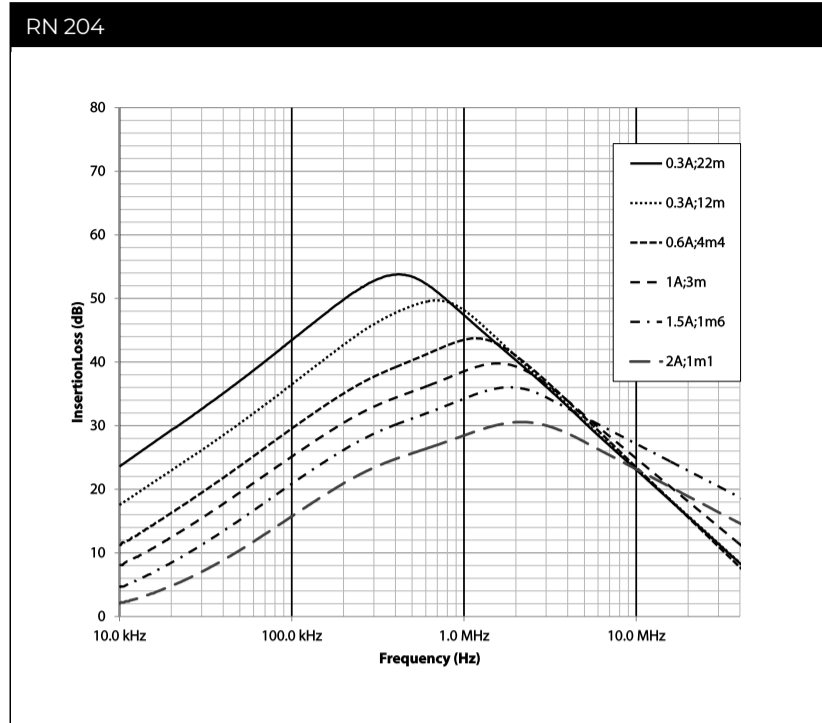
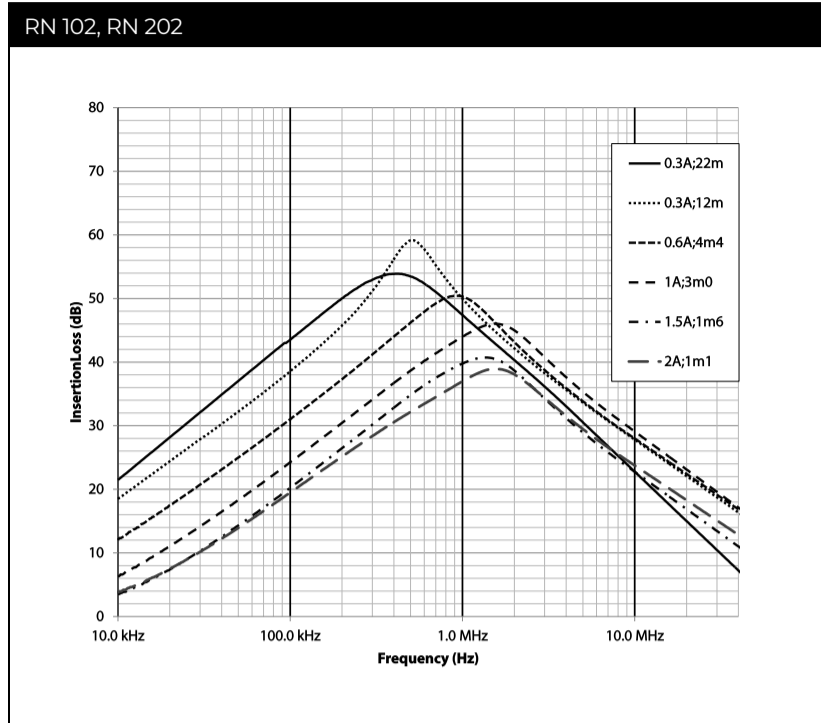

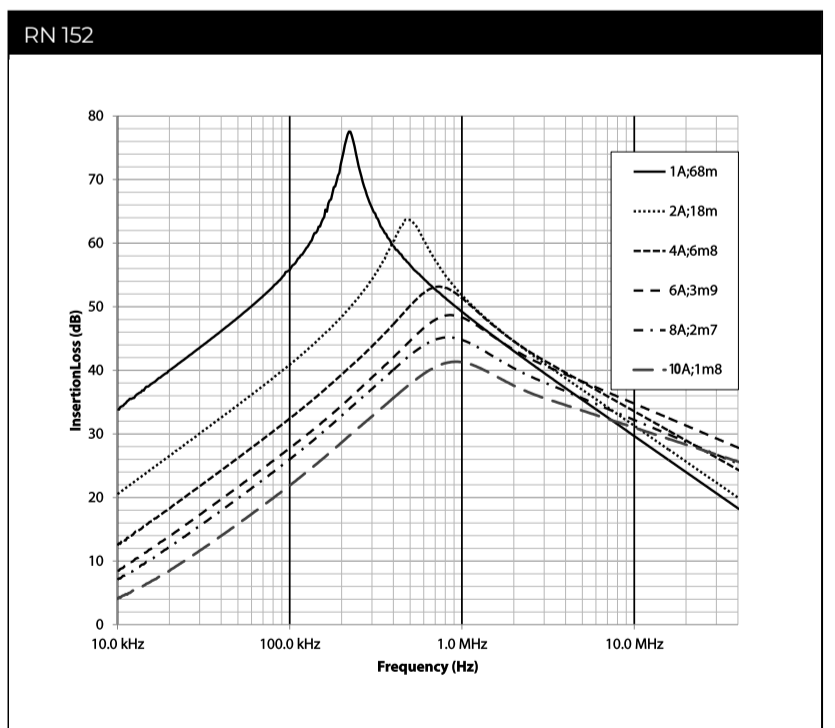
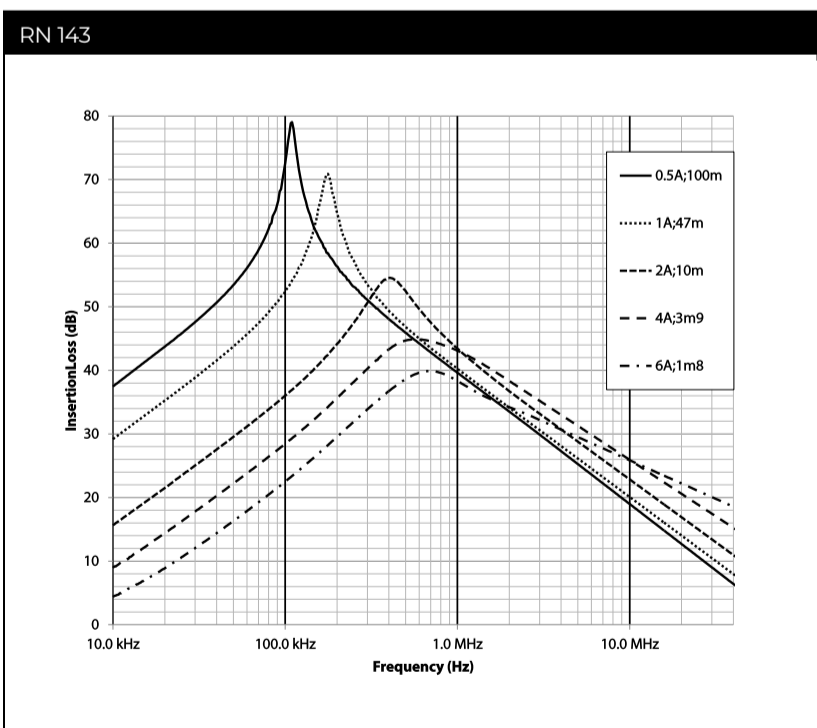
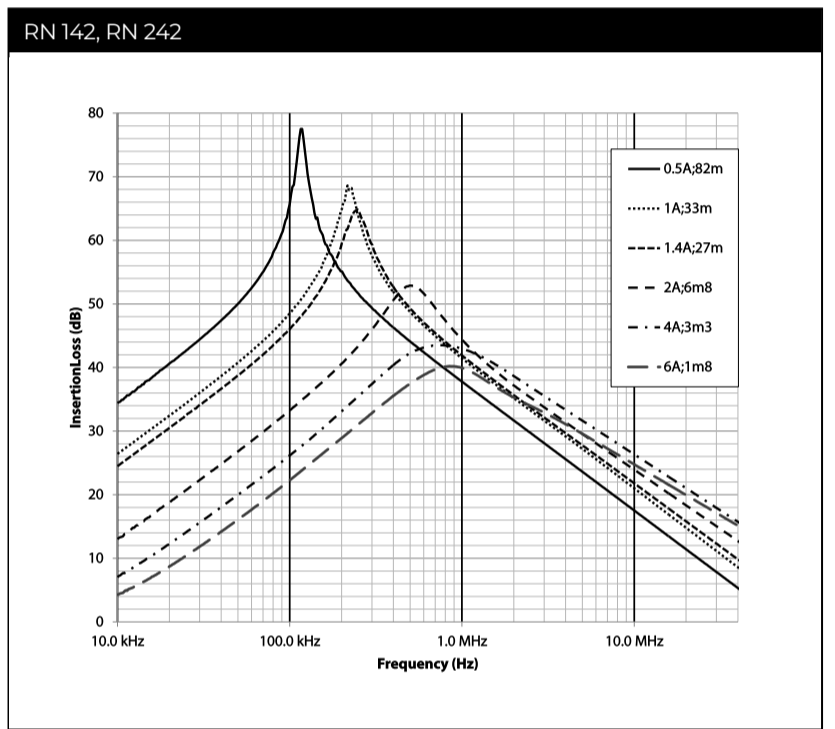
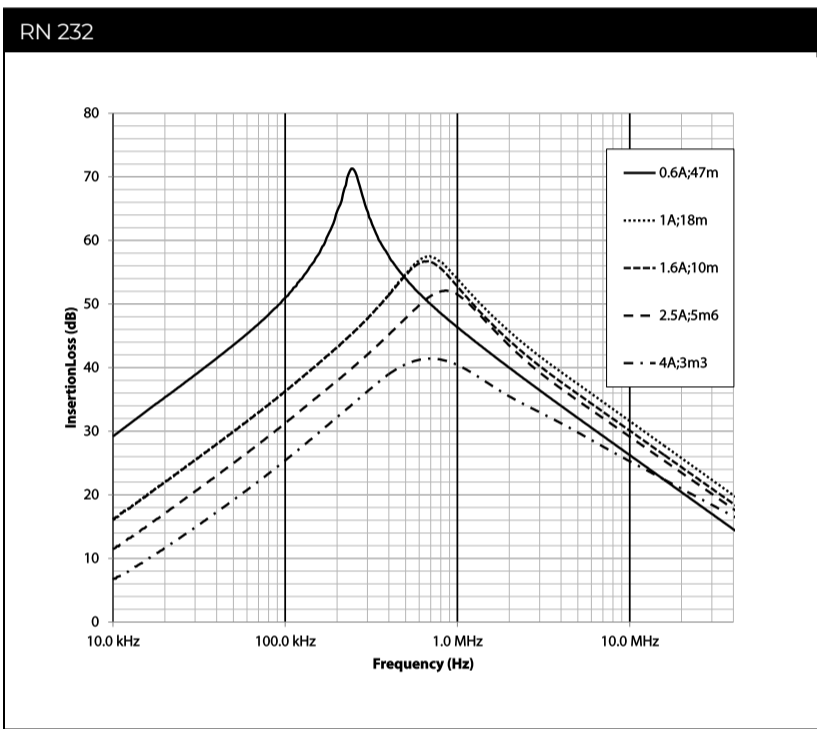
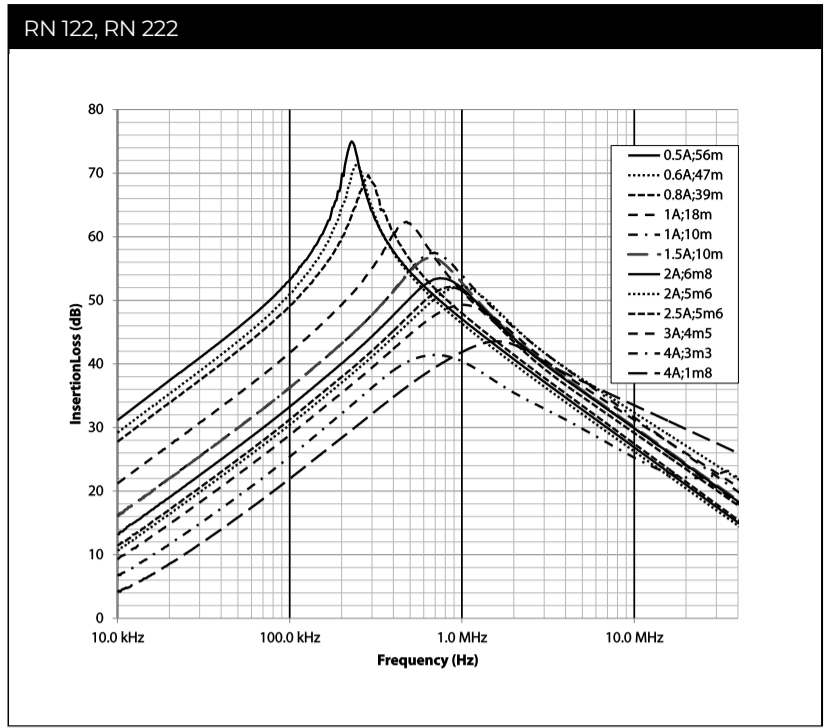
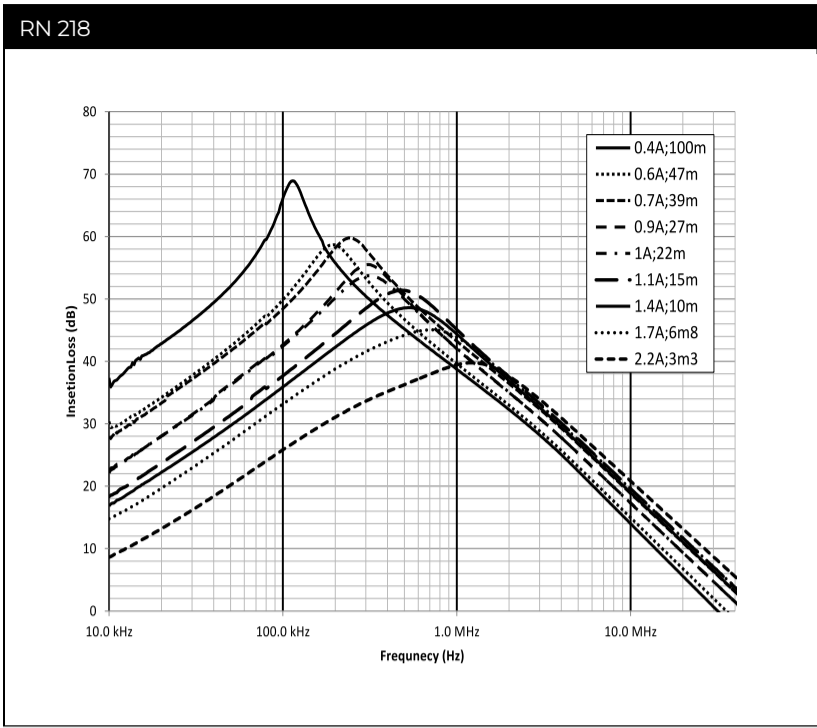

Mechanical Data

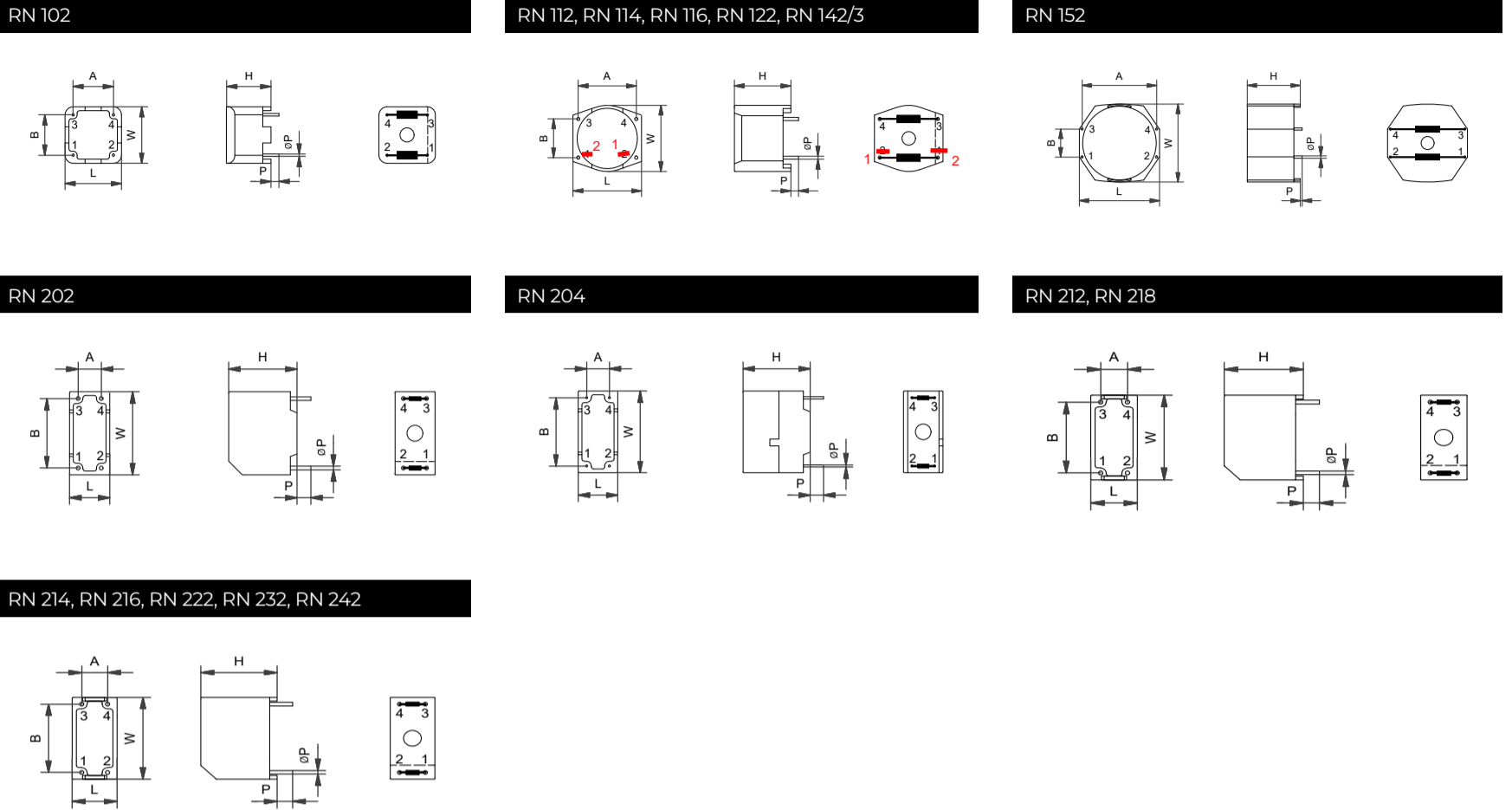

Pin material: Steel (base), Cu (under plating), Sn (final plating 6µm)

Dimensions

	A (±0.6 mm)	B (±0.6 mm)	H (±0.3 mm)	L (±0.3 mm)	W (±0.3 mm)	P (±0.5 mm)	ØP (±0.1 mm)
RN 102	10.0 mm	10.0 mm	9.0 mm	14.0 mm	14.0 mm	4.0 mm	0.6 mm
RN 112	15.0 mm	10.0 mm	12.6 mm	17.7 mm	17.1 mm	4.0 mm	0.8 mm
RN 114	20.1 mm	12.5 mm	13.2 mm	22.5 mm	21.5 mm	4.0 mm	0.8 mm
RN 116	20.1 mm	12.5 mm	13.2 mm	22.5 mm	21.5 mm	4.0 mm	0.8 mm
RN 122	25.0 mm	15.0 mm	16.5 mm	28.0 mm	27.0 mm	4.0 mm	0.8 mm
RN 142	30.0 mm	20.0 mm	19.7 mm	33.1 mm	32.5 mm	4.3 mm	0.8 mm
RN 143	30.0 mm	20.0 mm	19.7 mm	33.1 mm	32.5 mm	4.3 mm	0.8 mm
RN 152	40.0 mm	15.0 mm	25.0 mm	43.0 mm	41.8 mm	4.5 mm	1.2 mm
RN 202	5.1 mm	15.2 mm	13.5 mm	8.8 mm	18.2 mm	4.5 mm	0.8 mm
RN 204	7.6 mm	10.0 mm	14.3 mm	9.0 mm	14.0 mm	4.0 mm	0.5 mm
RN 212	10.0 mm	15.0 mm	20.0 mm	12.5 mm	18.0 mm	4.0 mm	0.8 mm
RN 214	12.5 mm	10.0 mm	25.0 mm	15.5 mm	23.0 mm	4.0 mm	0.8 mm
RN 216	12.5 mm	10.0 mm	25.0 mm	15.5 mm	23.0 mm	4.0 mm	0.8 mm
RN 218	10.0 mm	12.5 mm	20.0 mm	12.5 mm	18.0 mm	4.0 mm	0.8 mm
RN 222	15.0 mm	12.5 mm	29.3 mm	18.0 mm	31.0 mm	4.0 mm	0.8 mm
RN 232	15.0 mm	12.5 mm	34.3 mm	18.0 mm	31.0 mm	4.2 mm	0.8 mm
RN 242	15.0 mm	12.5 mm	34.3 mm	18.0 mm	31.0 mm	4.2 mm	0.8 mm

Please visit www.schaffner.com to find more details on filter connections.

We are here to help



Read more insights from TE's experts:

Connect With Us

We make it easier to connect with our experts and are ready to provide the support you need. Visit te.com/support to chat with a Product Information Specialist.

te.com

©2025 TE Connectivity plc. All Rights Reserved.

TE Connectivity, TE, TE connectivity (logo), and EVERY CONNECTION COUNTS, ECOSine, Schaffner are trademarks owned or licensed by TE Connectivity plc. family of companies. All other logos, products and/or company names referred to herein might be trademarks of their respective owners.

While TE has made every reasonable effort to ensure the accuracy of the information in this document, TE does not guarantee that it is error-free, nor does TE make any other representation, warranty or guarantee that the information is accurate, correct, reliable or current. TE reserves the right to make any changes to the information contained herein without prior notice. TE Connectivity assumes only those obligations set forth in the terms and conditions for this product and shall in no event be liable for any incidental, indirect, or consequential damages arising out of the sale, resale, use, or misapplication of the product. TE expressly disclaims any implied warranties with respect to the information contained herein, including, but not limited to, implied warranties of merchantability or fitness for a particular purpose. Dimensions, specifications and/or information contained herein are for reference purposes only and are subject to change without notice. Consult TE for the latest dimensions, specifications and/or information. Users of TE Connectivity products must make their own assessment as to whether the respective product is suitable for the respective desired application.

ED 01/25

schaffner
MORE POWER TO YOU

is now part of

TE
connectivity