

features

- Power-On Reset Generator with Fixed Delay Time of 200 ms, no External Capacitor Needed
- Precision Supply Voltage Monitor 2.5 V, 3 V, 3.3 V, and 5 V
- Pin-For-Pin Compatible with the MAX705 through MAX708 Series
- Integrated Watchdog Timer (TPS3705 only)
- Voltage Monitor for Power-Fail or Low-Battery Warning
- Maximum Supply Current of 50 μ A
- MSOP-8 and SO-8 Packages
- Temperature Range . . . -40°C to 85°C

typical applications

- Designs Using DSPs, Microcontrollers or Microprocessors
- Industrial Equipment
- Programmable Controls
- Automotive Systems
- Portable/Battery Powered Equipment
- Intelligent Instruments
- Wireless Communication Systems
- Notebook/Desktop Computers

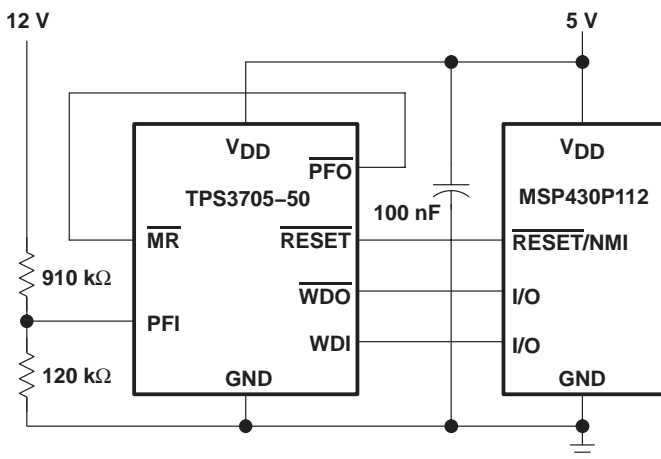
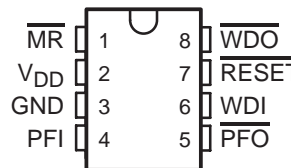
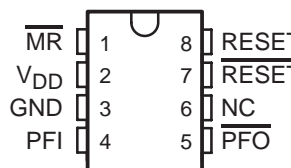

Figure 1. Typical MSP430 Application

TPS3705 . . . D PACKAGE (TOP VIEW)



TPS3707 . . . D PACKAGE (TOP VIEW)



NC – No internal connection

TPS3705 . . . DGN PACKAGE (TOP VIEW)

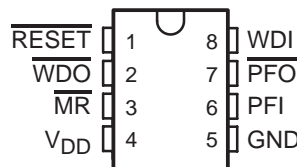

TPS3707 . . . DGN PACKAGE (TOP VIEW)

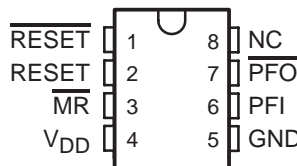

NC – No internal connection



Please be aware that an important notice concerning availability, standard warranty, and use in critical applications of Texas Instruments semiconductor products and disclaimers thereto appears at the end of this data sheet.

PRODUCTION DATA information is current as of publication date. Products conform to specifications per the terms of Texas Instruments standard warranty. Production processing does not necessarily include testing of all parameters.



TPS3705-xx
TPS3707-xx
PROCESSOR SUPERVISORY CIRCUITS WITH POWER-FAIL

SLVS184C – NOVEMBER 1998 – REVISED DECEMBER 2005

description

The TPS3705, TPS3707 family of microprocessor supply-voltage supervisors provide circuit initialization and timing supervision, primarily for DSP and processor-based systems.

During power-on, $\overline{\text{RESET}}$ is asserted when the supply voltage V_{DD} becomes higher than 1.1 V. Thereafter, the supply voltage supervisor monitors V_{DD} and keeps $\overline{\text{RESET}}$ active as long as V_{DD} remains below the threshold voltage $V_{\text{IT+}}$. An internal timer delays the return of the output to the inactive state (high) to ensure proper system reset. The delay time, $t_{\text{dtyp}} = 200$ ms, starts after V_{DD} has risen above the threshold voltage $V_{\text{IT+}}$. When the supply voltage drops below the threshold voltage $V_{\text{IT-}}$, the output becomes active (low) again. No external components are required. All the devices of this family have a fixed-sense threshold voltage $V_{\text{IT-}}$ set by an internal voltage divider.

The TPS3705-xx and TPS3707-xx devices incorporate a manual reset input, $\overline{\text{MR}}$. A low level at $\overline{\text{MR}}$ causes $\overline{\text{RESET}}$ to become active.

The TPS370x-xx families integrate a power-fail comparator which can be used for low-battery detection, power-fail warning, or for monitoring a power supply other than the main supply.

The TPS3705-xx devices have a watchdog timer that is periodically triggered by a positive or negative transition at WDI. When the supervising system fails to retrigger the watchdog circuit within the time-out interval, $t_{\text{(out)}} = 1.6$ s, $\overline{\text{WDO}}$ becomes active. This event also reinitializes the watchdog timer. Leaving WDI unconnected disables the watchdog.

The TPS3707-xx devices do not have the Watchdog function, but include a high-level output RESET.

The product spectrum is designed for supply voltages of 2.5 V, 3 V, 3.3 V, and 5 V. The circuits are available in either 8-pin MSOP or standard SOIC packages. The TPS3705, TPS3707 devices are characterized for operation over a temperature range of -40°C to 85°C .

AVAILABLE OPTIONS

T_{A}	THRESHOLD VOLTAGE	PACKAGED DEVICES		MARKING DGN PACKAGE	CHIP FORM (Y)
		SMALL OUTLINE (D)	POWER-PAD™ μ-SMALL OUTLINE (DGN)		
-40°C to 85°C	2.63 V	TPS3705-30D	TPS3705-30DGN	TIAAT	TPS3705-30Y
	2.93 V	TPS3705-33D	TPS3705-33DGN	TIAAU	TPS3705-33Y
	4.55 V	TPS3705-50D	TPS3705-50DGN	TIAAV	TPS3705-50Y
	2.25 V	TPS3707-25D	TPS3707-25DGN	TIAAW	TPS3707-25Y
	2.63 V	TPS3707-30D	TPS3707-30DGN	TIAAX	TPS3707-30Y
	2.93 V	TPS3707-33D	TPS3707-33DGN	TIAAY	TPS3707-33Y
	4.55 V	TPS3707-50D	TPS3707-50DGN	TIAAZ	TPS3707-50Y



PROCESSOR SUPERVISORY CIRCUITS WITH POWER-FAIL

SLVS184C – NOVEMBER 1998 – REVISED DECEMBER 2005

Function Tables

TRUTH TABLE, TPS3705

$\overline{\text{MR}}$	$V_{\text{DD}} > V_{\text{IT}}$	$\overline{\text{RESET}}$	TYPICAL DELAY
H→L	1	H→L	30 ns
L→H	1	L→H	200 ms
H	1→0	H→L	3 μs
H	0→1	L→H	200 ms

TRUTH TABLE, TPS3707

$\overline{\text{MR}}$	$V_{\text{DD}} > V_{\text{IT}}$	$\overline{\text{RESET}}$	RESET	TYPICAL DELAY
H→L	1	H→L	L→H	30 ns
L→H	1	L→H	H→L	200 ms
H	1→0	H→L	L→H	3 μs
H	0→1	L→H	H→L	200 ms

TRUTH TABLE, TPS370x

$\text{PFI} > V_{\text{IT}}$	$\overline{\text{PFO}}$	TYPICAL DELAY
0→1	L→H	0.5 μs
1→0	H→L	0.5 μs

functional block diagram

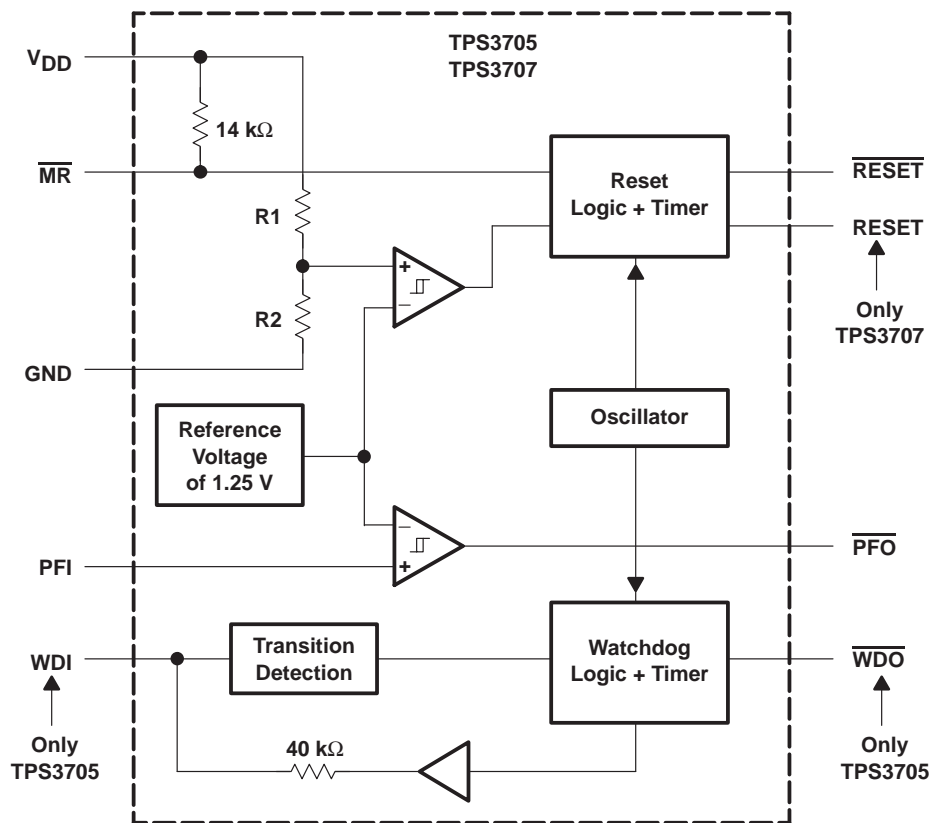

TPS3705-xx
 TPS3707-xx
PROCESSOR SUPERVISORY CIRCUITS WITH POWER-FAIL
 SLVS184C – NOVEMBER 1998 – REVISED DECEMBER 2005

timing diagrams

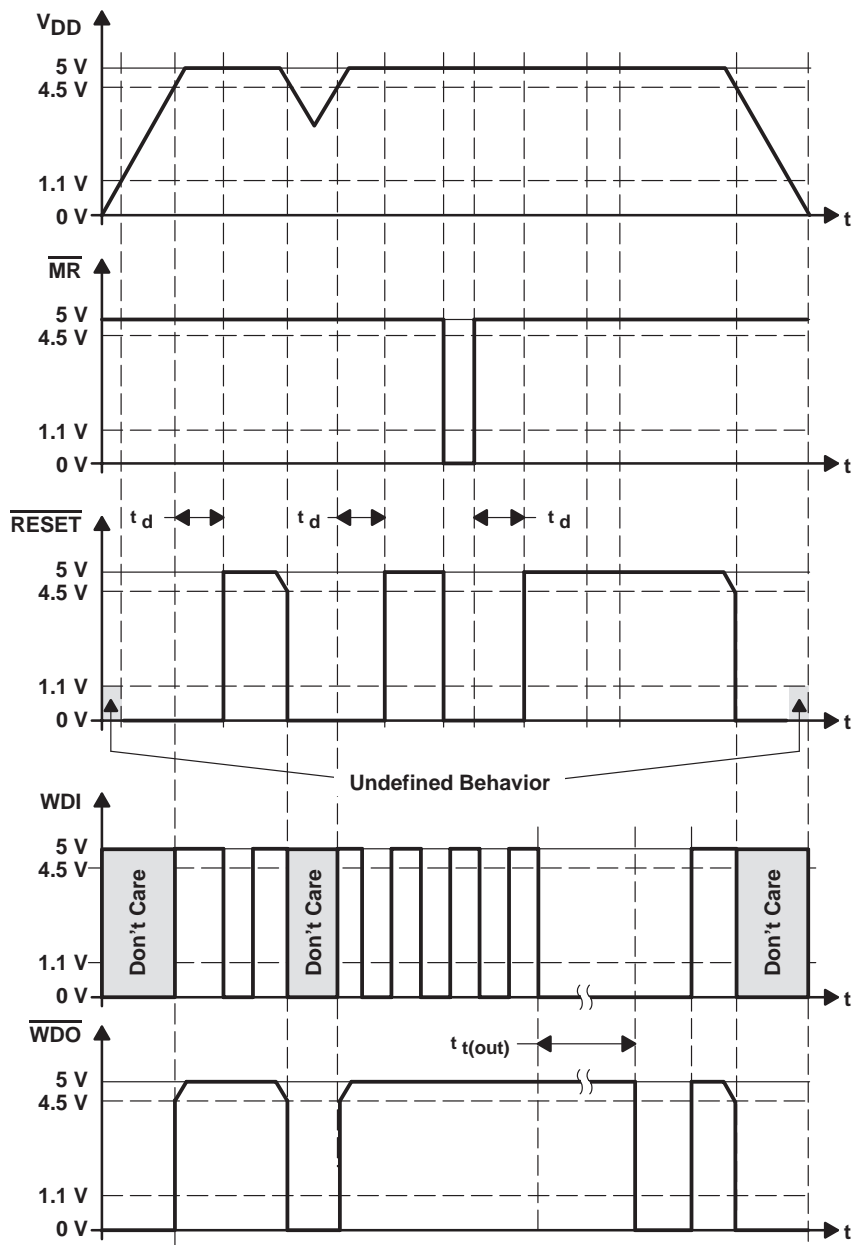

TPS370xY chip information

These chips, when properly assembled, display characteristics similar to those of the TPS370x. Thermal compression or ultrasonic bonding may be caused on the doped-aluminum bonding pads. The chips may be mounted with conductive epoxy or a gold-silicon preform.

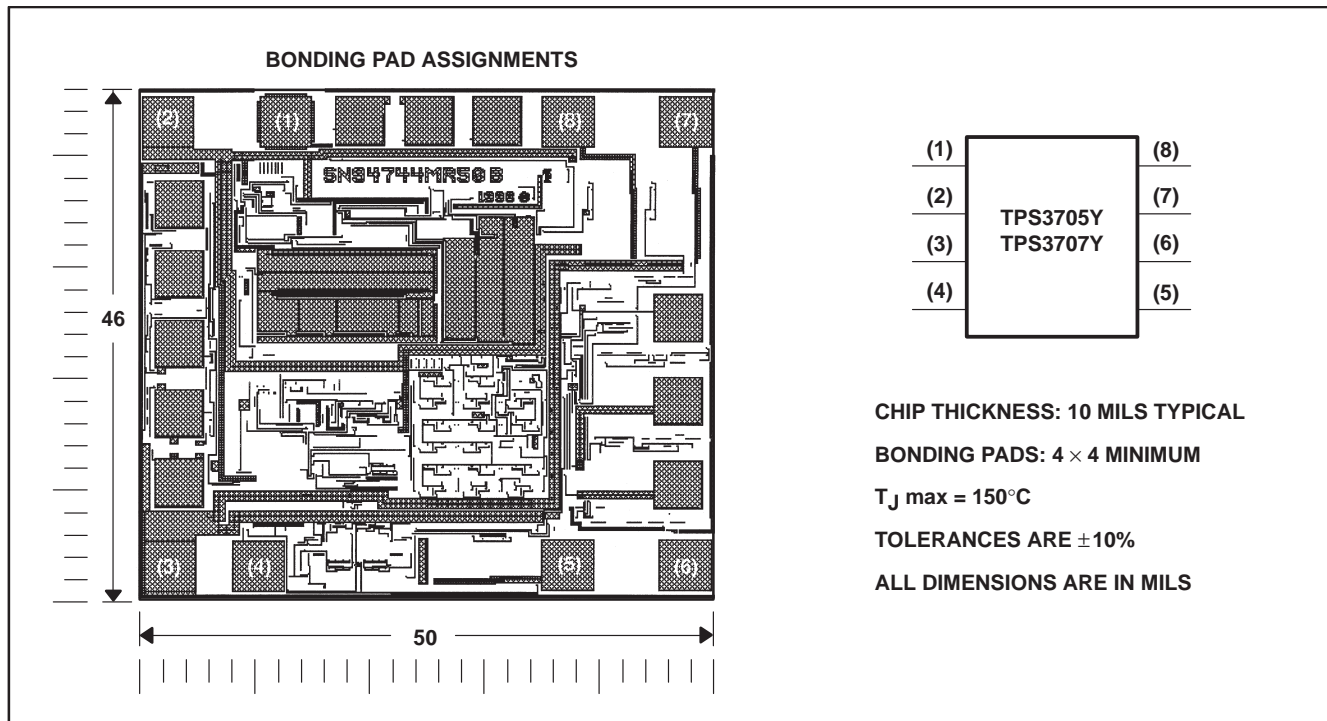

Terminal Functions

TERMINAL NAME		NO.	I/O	DESCRIPTION
$\overline{\text{MR}}$		1	I	Manual reset
VDD		2		Supply voltage
GND		3		Ground
PFI		4	I	Power-fail comparator input
$\overline{\text{PFO}}$		5	O	Power-fail comparator output
WDI	TPS3705	6	I	Watchdog timer input
NC	TPS3707			No internal connection
$\overline{\text{RESET}}$		7	O	Active-low reset output
$\overline{\text{WDO}}$	TPS3705	8	O	Watchdog timer output
RESET	TPS3707			Active-high reset output

absolute maximum ratings over operating free-air temperature (unless otherwise noted)†

Supply voltage, V_{DD} (see Note1)	7 V
PFI voltage range, V_{PFI}	-0.3 V to $V_{DD} + 0.3$ V
All other pins (see Note 1)	-0.3 V to 7 V
Maximum low output current, I_{OL}	5 mA
Maximum high output current, I_{OH}	-5 mA
Input clamp current, I_{IK} ($V_I < 0$ or $V_I > V_{DD}$)	± 20 mA
Output clamp current, I_{OK} ($V_O < 0$ or $V_O > V_{DD}$)	± 20 mA
Continuous total power dissipation	See Dissipation Rating Table
Operating free-air temperature range, T_A	-40°C to 85°C
Storage temperature range, T_{stg}	-65°C to 150°C
Soldering temperature	260°C

† Stresses beyond those listed under “absolute maximum ratings” may cause permanent damage to the device. These are stress ratings only, and functional operation of the device at these or any other conditions beyond those indicated under “recommended operating conditions” is not implied. Exposure to absolute–maximum–rated conditions for extended periods may affect device reliability.

NOTE 1: All voltage values are with respect to GND. For reliable operation the device must not be operated at 7 V for more than $t = 1000h$ continuously.

DISSIPATION RATING TABLE

PACKAGE	$T_A < 25^\circ\text{C}$ POWER RATING	DERATING FACTOR ABOVE $T_A = 25^\circ\text{C}$	$T_A = 70^\circ\text{C}$ POWER RATING	$T_A = 85^\circ\text{C}$ POWER RATING
DGN	2.14 W	17.1 mW/°C	1.37 W	1.11 W
D	725 mW	5.8 mW/°C	464 mW	377 mW

recommended operating conditions at specified temperature range

	MIN	MAX	UNIT
Supply voltage, V_{DD}	2	6	V
Input voltage, V_I	0	$V_{DD} + 0.3$	V
High-level input voltage, V_{IH}	$0.7 \times V_{DD}$		V
Low-level input voltage, V_{IL}	$0.3 \times V_{DD}$		V
Input transition rise and fall rate at \overline{MR} or WDI , $\Delta t/\Delta V$	100		ns/V
Operating free-air temperature range, T_A	-40	85	°C

TPS3705-xx
TPS3707-xx

PROCESSOR SUPERVISORY CIRCUITS WITH POWER-FAIL

SLVS184C – NOVEMBER 1998 – REVISED DECEMBER 2005

electrical characteristics over recommended operating free-air temperature range (unless otherwise noted)

PARAMETER		TEST CONDITIONS		MIN	TYP	MAX	UNIT		
V _{OH}	High-level output voltage	TPS370x-xx	V _{DD} = 1.1 V, I _{OH} = -4 μA	0.8			V		
		TPS3707-25	V _{DD} = V _{IT+} + 0.2 V, I _{OH} = -500 μA	0.7×V _{DD}					
		TPS370x-30							
		TPS370x-33							
		TPS370x-50	V _{DD} = V _{IT+} + 0.2 V, I _{OH} = -800 μA	V _{DD} - 1.5 V					
TPS370x-xx	V _{DD} = 6 V, I _{OH} = -800 μA								
V _{OL}	Low-level output voltage	TPS3707-25	V _{DD} = V _{IT+} + 0.2 V, I _{OL} = 1 mA				0.3		
		TPS370x-30							
		TPS370x-33							
		TPS370x-50	V _{DD} = V _{IT+} + 0.2 V, I _{OL} = 2.5 mA				0.4		
		TPS370x-xx	V _{DD} = 6 V, I _{OL} = 3 mA						
Power-up reset voltage (see Note 2)		V _{DD} ≥ 1.1 V, I _{OL} = 50 μA				0.3	V		
V _{IT-}	Negative-going input threshold voltage (see Note 3)	TPS3707-25	T _A = 0°C to 85°C	2.20	2.25	2.30	V		
		TPS370x-30		2.57	2.63	2.68			
		TPS370x-33		2.87	2.93	2.98			
		TPS370x-50		4.45	4.55	4.63			
		TPS3707-25	T _A = -40°C to 85°C	2.20	2.25	2.32	V		
		TPS370x-30		2.57	2.63	2.70			
		TPS370x-33		2.87	2.93	3.0			
		TPS370x-50		4.45	4.55	4.65			
	PFI	TPS370x-xx	V _{DD} ≥ 2 V, T _A = -40°C to 85°C	1.20	1.25	1.30	V		
	V _{hys}	Hysteresis	V _{DD}	TPS3707-25	40			mV	
TPS370x-30				50					
TPS370x-33				50					
TPS370x-50				70					
PFI			TPS370x-xx	10					
I _{IH(AV)}	Average high-level input current	WDI		WDI = V _{DD} = 6 V, Time average (dc = 88%)		100	150	μA	
I _{IL(AV)}	Average low-level input current			WDI = 0 V, V _{DD} = 6 V, Time average (dc = 12%)		-15	-20	μA	
I _{IH}	High-level input current	WDI		WDI = V _{DD} = 6 V		120	170	μA	
		MR		MR = 0.7×V _{DD} , V _{DD} = 6 V		-130	-180		
I _{IL}	Low-level input current	WDI		WDI = 0 V, V _{DD} = 6 V		-120	-170	μA	
		MR		MR = 0 V, V _{DD} = 6 V		-430	-600		
I _I	Input current	PFI		V _{DD} = 6 V, 0 V ≤ V _I ≤ V _{DD}		-1	0	1	μA
I _{DD}	Supply current	TPS3707-xx		V _{DD} = 2 V to 6 V, MR = V _{DD} , MR, WDI and outputs unconnected		20	50	μA	
		TPS3705-xx		V _{DD} = 2 V to 6 V, MR = V _{DD} , MR, WDI and outputs unconnected		30	50	μA	
C _i	Input capacitance			V _I = 0 V to V _{DD}		5		pF	

NOTES: 2. The lowest supply voltage at which RESET becomes active. t_rV_{DD} ≥ 15 μs/V
3. To ensure best stability of the threshold voltage, a bypass capacitor (ceramic, 0.1 μF) should be placed near to the supply terminals.



PROCESSOR SUPERVISORY CIRCUITS WITH POWER-FAIL

SLVS184C – NOVEMBER 1998 – REVISED DECEMBER 2005

timing requirements at $R_L = 1\text{ M}\Omega$, $C_L = 50\text{ pF}$, $T_A = 25^\circ\text{C}$

PARAMETER		TEST CONDITIONS	MIN	TYP	MAX	UNIT
t_w	Pulse width					
	at V_{DD}	$V_{DD} = V_{IT+} + 0.2\text{ V}$, $V_{DD} = V_{IT-} - 0.2\text{ V}$	6			μs
	at $\overline{\text{MR}}$	$V_{DD} \geq V_{IT+} + 0.2\text{ V}$, $V_{IL} = 0.3 \times V_{DD}$, $V_{IH} = 0.7 \times V_{DD}$	100			ns
	at WDI	$V_{DD} \geq V_{IT+} + 0.2\text{ V}$, $V_{IL} = 0.3 \times V_{DD}$, $V_{IH} = 0.7 \times V_{DD}$	100			ns

switching characteristics at $R_L = 1\text{ M}\Omega$, $C_L = 50\text{ pF}$, $T_A = 25^\circ\text{C}$

PARAMETER		TEST CONDITIONS	MIN	TYP	MAX	UNIT
$t_{t(out)}$	Watchdog time out	$V_{DD} \geq V_{IT+} + 0.2\text{ V}$, See timing diagram	1.1	1.6	2.3	s
t_d	Delay time	$V_{DD} > V_{IT+} + 0.2\text{ V}$, See timing diagram	140	200	280	ms
t_{PHL}	Propagation (delay) time, high-to-low-level output	$\overline{\text{MR}}$ to $\overline{\text{RESET}}$ delay		50	250	ns
t_{PLH}	Propagation (delay) time, low-to-high-level output	$\overline{\text{MR}}$ to $\overline{\text{RESET}}$ delay (TPS3707-xx only)		50	250	
t_{PHL}	Propagation (delay) time, high-to-low-level output	V_{DD} to $\overline{\text{RESET}}$ delay		3	5	μs
t_{PLH}	Propagation (delay) time, low-to-high-level output	V_{DD} to $\overline{\text{RESET}}$ delay (TPS3707-xx only)		3	5	
t_{PHL}	Propagation (delay) time, high-to-low-level output	PFI to $\overline{\text{PFO}}$ delay	$V_{DD} = 2\text{ V to }6\text{ V}$	0.5	1	μs
t_{PLH}	Propagation (delay) time, low-to-high-level output			0.5	1	

TYPICAL CHARACTERISTICS

NORMALIZED INPUT THRESHOLD VOLTAGE
vs
FREE-AIR TEMPERATURE AT V_{DD}

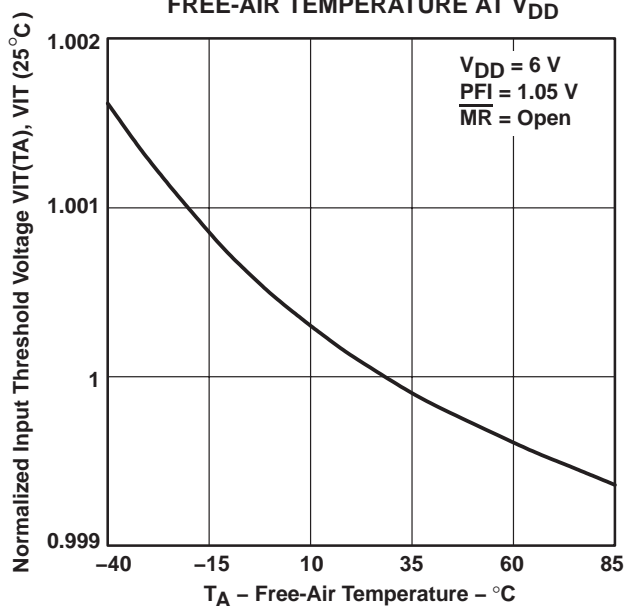

Figure 2

SUPPLY CURRENT
vs
SUPPLY VOLTAGE

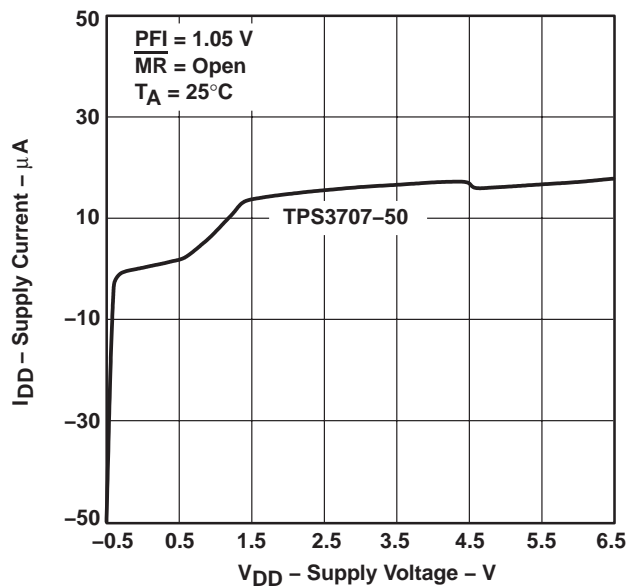

Figure 3

INPUT CURRENT
vs
INPUT VOLTAGE AT \overline{MR}

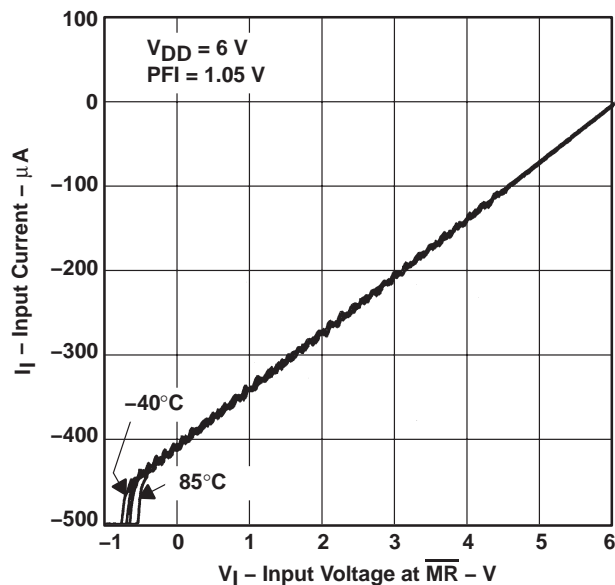

Figure 4

TYPICAL CHARACTERISTICS

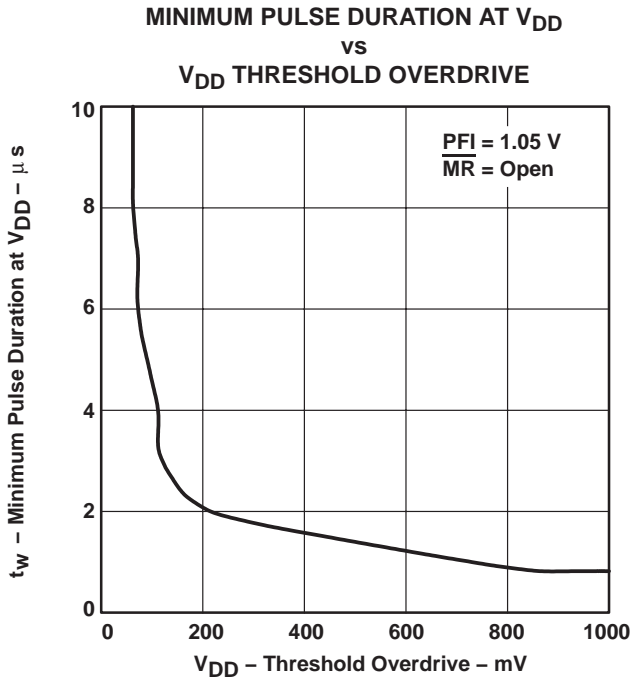

Figure 5

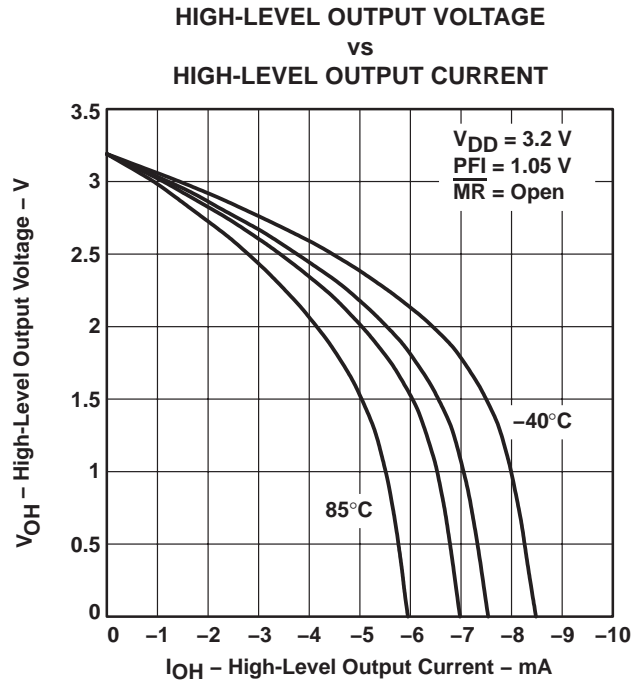

Figure 6

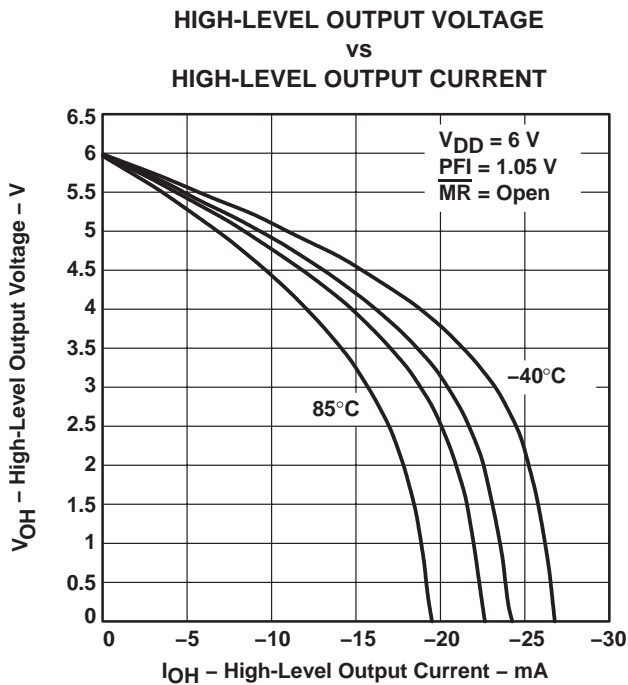

Figure 7

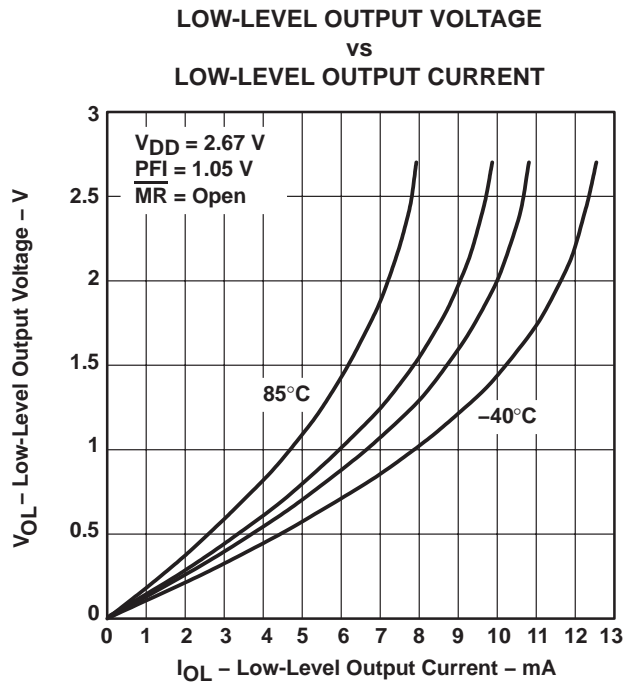

Figure 8

PACKAGING INFORMATION

Orderable Device	Status ⁽¹⁾	Package Type	Package Drawing	Pins	Package Qty	Eco Plan ⁽²⁾	Lead/Ball Finish	MSL Peak Temp ⁽³⁾
TPS3705-30D	ACTIVE	SOIC	D	8	75	Green (RoHS & no Sb/Br)	CU NIPDAU	Level-1-260C-UNLIM
TPS3705-30DGN	ACTIVE	MSOP-Power PAD	DGN	8	80	Green (RoHS & no Sb/Br)	CU NIPDAU	Level-1-260C-UNLIM
TPS3705-30DGNG4	ACTIVE	MSOP-Power PAD	DGN	8	80	Green (RoHS & no Sb/Br)	CU NIPDAU	Level-1-260C-UNLIM
TPS3705-30DR	ACTIVE	SOIC	D	8	2500	Green (RoHS & no Sb/Br)	CU NIPDAU	Level-1-260C-UNLIM
TPS3705-30DRG4	ACTIVE	SOIC	D	8	2500	Green (RoHS & no Sb/Br)	CU NIPDAU	Level-1-260C-UNLIM
TPS3705-33D	ACTIVE	SOIC	D	8	75	Green (RoHS & no Sb/Br)	CU NIPDAU	Level-1-260C-UNLIM
TPS3705-33DG4	ACTIVE	SOIC	D	8	75	Green (RoHS & no Sb/Br)	CU NIPDAU	Level-1-260C-UNLIM
TPS3705-33DGN	ACTIVE	MSOP-Power PAD	DGN	8	80	Green (RoHS & no Sb/Br)	CU NIPDAU	Level-1-260C-UNLIM
TPS3705-33DGNG4	ACTIVE	MSOP-Power PAD	DGN	8	80	Green (RoHS & no Sb/Br)	CU NIPDAU	Level-1-260C-UNLIM
TPS3705-33DGNR	ACTIVE	MSOP-Power PAD	DGN	8	2500	Green (RoHS & no Sb/Br)	CU NIPDAU	Level-1-260C-UNLIM
TPS3705-33DGNRG4	ACTIVE	MSOP-Power PAD	DGN	8	2500	Green (RoHS & no Sb/Br)	CU NIPDAU	Level-1-260C-UNLIM
TPS3705-33DR	ACTIVE	SOIC	D	8	2500	Green (RoHS & no Sb/Br)	CU NIPDAU	Level-1-260C-UNLIM
TPS3705-33DRG4	ACTIVE	SOIC	D	8	2500	Green (RoHS & no Sb/Br)	CU NIPDAU	Level-1-260C-UNLIM
TPS3705-50D	ACTIVE	SOIC	D	8	75	Green (RoHS & no Sb/Br)	CU NIPDAU	Level-1-260C-UNLIM
TPS3705-50DG4	ACTIVE	SOIC	D	8	75	Green (RoHS & no Sb/Br)	CU NIPDAU	Level-1-260C-UNLIM
TPS3705-50DGN	ACTIVE	MSOP-Power PAD	DGN	8	80	Green (RoHS & no Sb/Br)	CU NIPDAU	Level-1-260C-UNLIM
TPS3705-50DGNG4	ACTIVE	MSOP-Power PAD	DGN	8	80	Green (RoHS & no Sb/Br)	CU NIPDAU	Level-1-260C-UNLIM
TPS3705-50DGNR	ACTIVE	MSOP-Power PAD	DGN	8	2500	Green (RoHS & no Sb/Br)	CU NIPDAU	Level-1-260C-UNLIM
TPS3705-50DGNRG4	ACTIVE	MSOP-Power PAD	DGN	8	2500	Green (RoHS & no Sb/Br)	CU NIPDAU	Level-1-260C-UNLIM
TPS3705-50DR	ACTIVE	SOIC	D	8	2500	Green (RoHS & no Sb/Br)	CU NIPDAU	Level-1-260C-UNLIM
TPS3705-50DRG4	ACTIVE	SOIC	D	8	2500	Green (RoHS & no Sb/Br)	CU NIPDAU	Level-1-260C-UNLIM

Orderable Device	Status ⁽¹⁾	Package Type	Package Drawing	Pins	Package Qty	Eco Plan ⁽²⁾	Lead/Ball Finish	MSL Peak Temp ⁽³⁾
						no Sb/Br)		
TPS3707-25D	ACTIVE	SOIC	D	8	75	Green (RoHS & no Sb/Br)	CU NIPDAU	Level-1-260C-UNLIM
TPS3707-25DGN	ACTIVE	MSOP-Power PAD	DGN	8	80	Green (RoHS & no Sb/Br)	CU NIPDAU	Level-1-260C-UNLIM
TPS3707-25DGNG4	ACTIVE	MSOP-Power PAD	DGN	8	80	Green (RoHS & no Sb/Br)	CU NIPDAU	Level-1-260C-UNLIM
TPS3707-25DGNR	ACTIVE	MSOP-Power PAD	DGN	8	2500	Green (RoHS & no Sb/Br)	CU NIPDAU	Level-1-260C-UNLIM
TPS3707-25DGNRG4	ACTIVE	MSOP-Power PAD	DGN	8	2500	Green (RoHS & no Sb/Br)	CU NIPDAU	Level-1-260C-UNLIM
TPS3707-25DR	ACTIVE	SOIC	D	8	2500	Green (RoHS & no Sb/Br)	CU NIPDAU	Level-1-260C-UNLIM
TPS3707-25DRG4	ACTIVE	SOIC	D	8	2500	Green (RoHS & no Sb/Br)	CU NIPDAU	Level-1-260C-UNLIM
TPS3707-30D	ACTIVE	SOIC	D	8	75	Green (RoHS & no Sb/Br)	CU NIPDAU	Level-1-260C-UNLIM
TPS3707-30DGN	ACTIVE	MSOP-Power PAD	DGN	8	80	Green (RoHS & no Sb/Br)	CU NIPDAU	Level-1-260C-UNLIM
TPS3707-30DGNG4	ACTIVE	MSOP-Power PAD	DGN	8	80	Green (RoHS & no Sb/Br)	CU NIPDAU	Level-1-260C-UNLIM
TPS3707-30DGNR	ACTIVE	MSOP-Power PAD	DGN	8	2500	Green (RoHS & no Sb/Br)	CU NIPDAU	Level-1-260C-UNLIM
TPS3707-30DGNRG4	ACTIVE	MSOP-Power PAD	DGN	8	2500	Green (RoHS & no Sb/Br)	CU NIPDAU	Level-1-260C-UNLIM
TPS3707-30DR	ACTIVE	SOIC	D	8	2500	Green (RoHS & no Sb/Br)	CU NIPDAU	Level-1-260C-UNLIM
TPS3707-30DRG4	ACTIVE	SOIC	D	8	2500	Green (RoHS & no Sb/Br)	CU NIPDAU	Level-1-260C-UNLIM
TPS3707-33D	ACTIVE	SOIC	D	8	75	Green (RoHS & no Sb/Br)	CU NIPDAU	Level-1-260C-UNLIM
TPS3707-33DG4	ACTIVE	SOIC	D	8	75	Green (RoHS & no Sb/Br)	CU NIPDAU	Level-1-260C-UNLIM
TPS3707-33DGN	ACTIVE	MSOP-Power PAD	DGN	8	80	Green (RoHS & no Sb/Br)	CU NIPDAU	Level-1-260C-UNLIM
TPS3707-33DGNG4	ACTIVE	MSOP-Power PAD	DGN	8	80	Green (RoHS & no Sb/Br)	CU NIPDAU	Level-1-260C-UNLIM
TPS3707-33DGNR	ACTIVE	MSOP-Power PAD	DGN	8	2500	Green (RoHS & no Sb/Br)	CU NIPDAU	Level-1-260C-UNLIM
TPS3707-33DGNRG4	ACTIVE	MSOP-Power PAD	DGN	8	2500	Green (RoHS & no Sb/Br)	CU NIPDAU	Level-1-260C-UNLIM

Orderable Device	Status ⁽¹⁾	Package Type	Package Drawing	Pins	Package Qty	Eco Plan ⁽²⁾	Lead/Ball Finish	MSL Peak Temp ⁽³⁾
TPS3707-33DR	ACTIVE	SOIC	D	8	2500	Green (RoHS & no Sb/Br)	CU NIPDAU	Level-1-260C-UNLIM
TPS3707-33DRG4	ACTIVE	SOIC	D	8	2500	Green (RoHS & no Sb/Br)	CU NIPDAU	Level-1-260C-UNLIM
TPS3707-50D	ACTIVE	SOIC	D	8	75	Green (RoHS & no Sb/Br)	CU NIPDAU	Level-1-260C-UNLIM
TPS3707-50DG4	ACTIVE	SOIC	D	8	75	Green (RoHS & no Sb/Br)	CU NIPDAU	Level-1-260C-UNLIM
TPS3707-50DGN	ACTIVE	MSOP-Power PAD	DGN	8	80	Green (RoHS & no Sb/Br)	CU NIPDAU	Level-1-260C-UNLIM
TPS3707-50DGNG4	ACTIVE	MSOP-Power PAD	DGN	8	80	Green (RoHS & no Sb/Br)	CU NIPDAU	Level-1-260C-UNLIM
TPS3707-50DGNR	ACTIVE	MSOP-Power PAD	DGN	8	2500	Green (RoHS & no Sb/Br)	CU NIPDAU	Level-1-260C-UNLIM
TPS3707-50DGNRG4	ACTIVE	MSOP-Power PAD	DGN	8	2500	Green (RoHS & no Sb/Br)	CU NIPDAU	Level-1-260C-UNLIM
TPS3707-50DR	ACTIVE	SOIC	D	8	2500	Green (RoHS & no Sb/Br)	CU NIPDAU	Level-1-260C-UNLIM
TPS3707-50DRG4	ACTIVE	SOIC	D	8	2500	Green (RoHS & no Sb/Br)	CU NIPDAU	Level-1-260C-UNLIM

⁽¹⁾ The marketing status values are defined as follows:

ACTIVE: Product device recommended for new designs.

LIFEBUY: TI has announced that the device will be discontinued, and a lifetime-buy period is in effect.

NRND: Not recommended for new designs. Device is in production to support existing customers, but TI does not recommend using this part in a new design.

PREVIEW: Device has been announced but is not in production. Samples may or may not be available.

OBSELETE: TI has discontinued the production of the device.

⁽²⁾ Eco Plan - The planned eco-friendly classification: Pb-Free (RoHS), Pb-Free (RoHS Exempt), or Green (RoHS & no Sb/Br) - please check <http://www.ti.com/productcontent> for the latest availability information and additional product content details.

TBD: The Pb-Free/Green conversion plan has not been defined.

Pb-Free (RoHS): TI's terms "Lead-Free" or "Pb-Free" mean semiconductor products that are compatible with the current RoHS requirements for all 6 substances, including the requirement that lead not exceed 0.1% by weight in homogeneous materials. Where designed to be soldered at high temperatures, TI Pb-Free products are suitable for use in specified lead-free processes.

Pb-Free (RoHS Exempt): This component has a RoHS exemption for either 1) lead-based flip-chip solder bumps used between the die and package, or 2) lead-based die adhesive used between the die and leadframe. The component is otherwise considered Pb-Free (RoHS compatible) as defined above.

Green (RoHS & no Sb/Br): TI defines "Green" to mean Pb-Free (RoHS compatible), and free of Bromine (Br) and Antimony (Sb) based flame retardants (Br or Sb do not exceed 0.1% by weight in homogeneous material)

⁽³⁾ MSL, Peak Temp. -- The Moisture Sensitivity Level rating according to the JEDEC industry standard classifications, and peak solder temperature.

Important Information and Disclaimer:The information provided on this page represents TI's knowledge and belief as of the date that it is provided. TI bases its knowledge and belief on information provided by third parties, and makes no representation or warranty as to the accuracy of such information. Efforts are underway to better integrate information from third parties. TI has taken and continues to take reasonable steps to provide representative and accurate information but may not have conducted destructive testing or chemical analysis on incoming materials and chemicals. TI and TI suppliers consider certain information to be proprietary, and thus CAS numbers and other limited information may not be available for release.

In no event shall TI's liability arising out of such information exceed the total purchase price of the TI part(s) at issue in this document sold by TI to Customer on an annual basis.

DGN (S-PDSO-G8)

PowerPAD™ PLASTIC SMALL-OUTLINE PACKAGE

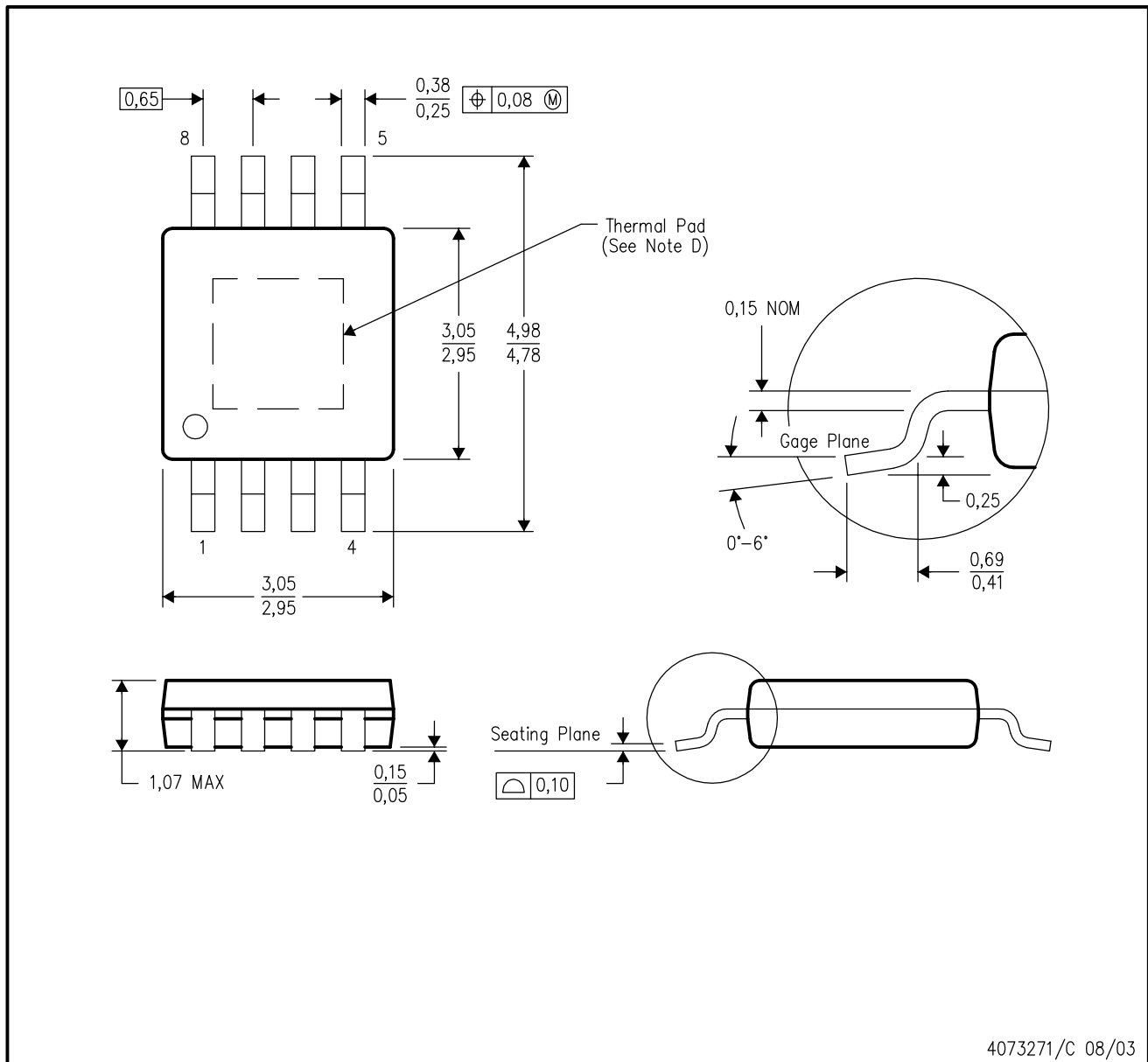

4073271/C 08/03

- NOTES:
- All linear dimensions are in millimeters.
 - This drawing is subject to change without notice.
 - Body dimensions do not include mold flash or protrusion.
 - This package is designed to be soldered to a thermal pad on the board. Refer to Technical Brief, PowerPad Thermally Enhanced Package, Texas Instruments Literature No. SLMA002 for information regarding recommended board layout. This document is available at www.ti.com <<http://www.ti.com>>.
 - Falls within JEDEC MO-187

PowerPAD is a trademark of Texas Instruments.

IMPORTANT NOTICE

Texas Instruments Incorporated and its subsidiaries (TI) reserve the right to make corrections, modifications, enhancements, improvements, and other changes to its products and services at any time and to discontinue any product or service without notice. Customers should obtain the latest relevant information before placing orders and should verify that such information is current and complete. All products are sold subject to TI's terms and conditions of sale supplied at the time of order acknowledgment.

TI warrants performance of its hardware products to the specifications applicable at the time of sale in accordance with TI's standard warranty. Testing and other quality control techniques are used to the extent TI deems necessary to support this warranty. Except where mandated by government requirements, testing of all parameters of each product is not necessarily performed.

TI assumes no liability for applications assistance or customer product design. Customers are responsible for their products and applications using TI components. To minimize the risks associated with customer products and applications, customers should provide adequate design and operating safeguards.

TI does not warrant or represent that any license, either express or implied, is granted under any TI patent right, copyright, mask work right, or other TI intellectual property right relating to any combination, machine, or process in which TI products or services are used. Information published by TI regarding third-party products or services does not constitute a license from TI to use such products or services or a warranty or endorsement thereof. Use of such information may require a license from a third party under the patents or other intellectual property of the third party, or a license from TI under the patents or other intellectual property of TI.

Reproduction of information in TI data books or data sheets is permissible only if reproduction is without alteration and is accompanied by all associated warranties, conditions, limitations, and notices. Reproduction of this information with alteration is an unfair and deceptive business practice. TI is not responsible or liable for such altered documentation.

Resale of TI products or services with statements different from or beyond the parameters stated by TI for that product or service voids all express and any implied warranties for the associated TI product or service and is an unfair and deceptive business practice. TI is not responsible or liable for any such statements.

Following are URLs where you can obtain information on other Texas Instruments products and application solutions:

Products		Applications	
Amplifiers	amplifier.ti.com	Audio	www.ti.com/audio
Data Converters	dataconverter.ti.com	Automotive	www.ti.com/automotive
DSP	dsp.ti.com	Broadband	www.ti.com/broadband
Interface	interface.ti.com	Digital Control	www.ti.com/digitalcontrol
Logic	logic.ti.com	Military	www.ti.com/military
Power Mgmt	power.ti.com	Optical Networking	www.ti.com/opticalnetwork
Microcontrollers	microcontroller.ti.com	Security	www.ti.com/security
		Telephony	www.ti.com/telephony
		Video & Imaging	www.ti.com/video
		Wireless	www.ti.com/wireless

Mailing Address: Texas Instruments
Post Office Box 655303 Dallas, Texas 75265

Copyright © 2006, Texas Instruments Incorporated