

4

3

2

1

THE INFORMATION CONTAINED HEREIN IS THE EXCLUSIVE PROPERTY OF VIRGINIA PANEL CORPORATION AND IS SUBMITTED FOR USE BY THE CUSTOMER ONLY. THE DATA SHALL NOT BE DUPLICATED, USED, OR DISCLOSED IN WHOLE OR IN PART FOR ANY PURPOSE OTHER THAN TO MAINTAIN THE EQUIPMENT PROVIDED.

REV	DESCRIPTION	DATE	ENGINEER
A	DRAWING ORIGATION ECN #6749	5/12/2016	C CHURCH

RIGHT ANGLE CONTACT LENGTHS 6

PIN #	TOTAL LENGTH
1	0.643 [16.3322]
2	0.747 [18.9738]
3	0.87 [22.098]
4	0.999 [25.3746]
5	1.128 [28.6512]
6	1.256 [31.9024]
7	1.385 [35.179]
8	1.517 [38.5318]

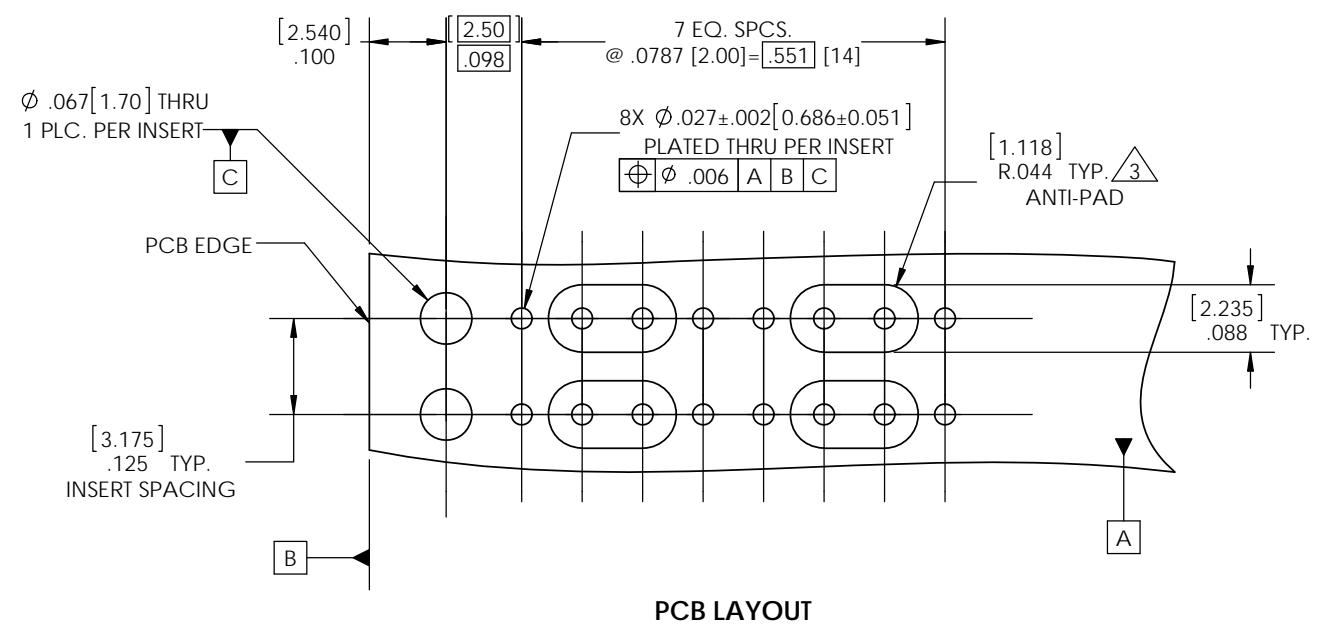
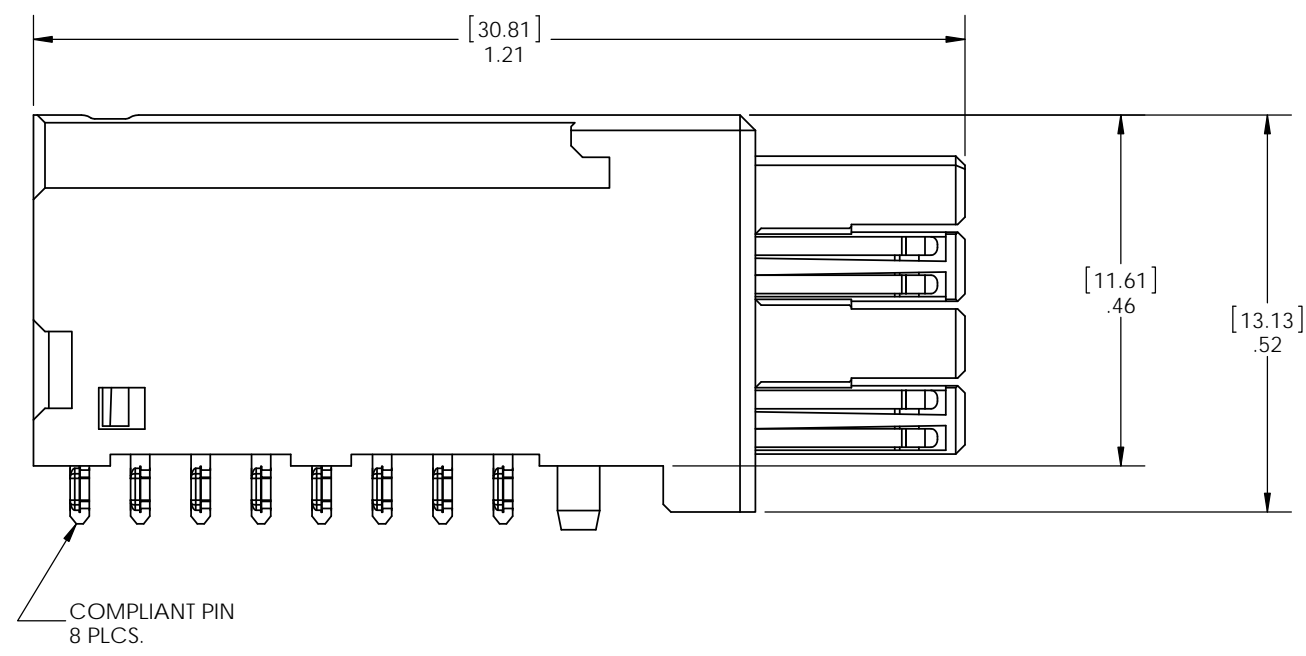
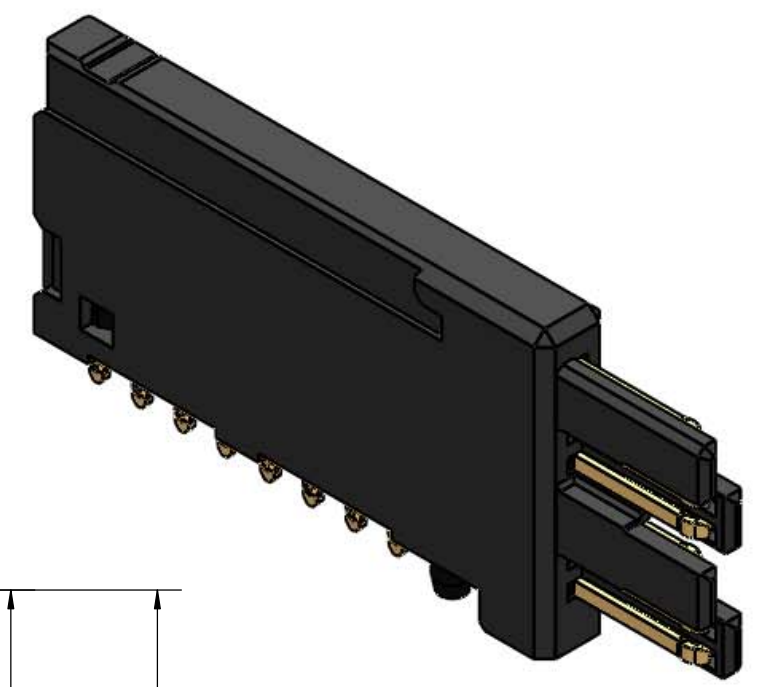
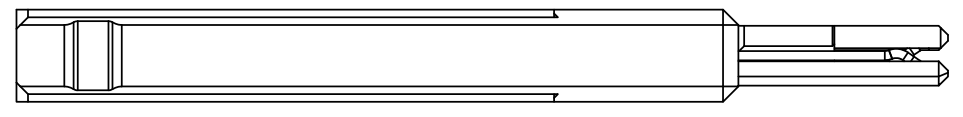
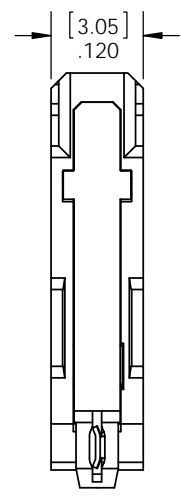

- 6 CONTACT LENGTHS ARE PROVIDED FOR TRACE LENGTH MATCHING.
 - 5. SEE SHEET TO FOR NOTE.
 - 4. RECOMMENDED PCB LAYOUT CONNECTOR MOUNTS THIS SIDE
BOARD THICKNESS = .062 [1.57]
DIMENSION TOLERANCE = ±.005 [.13] UNLESS OTHERWISE SPECIFIED
 - 3 ANTI-PAD REQUIRED FOR USE WITH HIGH SPEED DIFFERENTIAL SIGNALS.
 - 2. SEE SHEET 2 FOR ADDITIONAL PCB LAYOUT INFORMATION.
 - 1. FOR APPLICATION USE AND CARE INFORMATION CONSULT VPC USERS GUIDE @ WWW.VPC.COM
- NOTES:

CUSTOMER DRAWING

**VTAC HSD
RIGHT ANGLE INSERT**

DWG. NO.	REV
610151104	A
SCALE	CAGE CODE
4:1	18117
SHEET	SHEET
1 OF 2	1 OF 2

4

3

2

1

RELATIVE CONNECTOR POSITIONS AND WIRE ROUTING ARE GENERIC AND MAY VARY WITH PINOUT

DIMENSIONS ARE SHOWN AS:
[MILLIMETERS]
INCHES

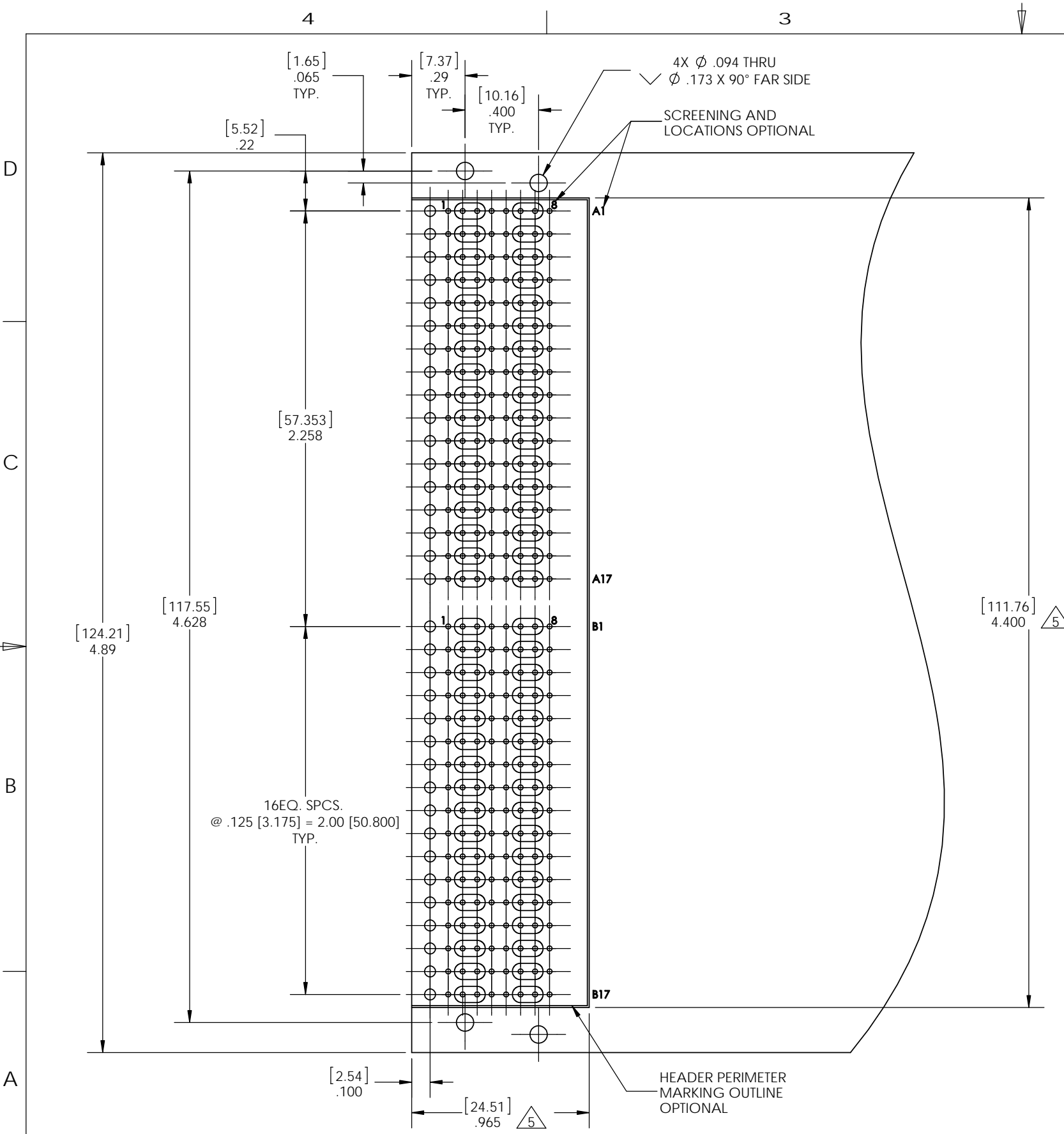

**90 SERIES PCB LAYOUT
COMPONENT SIDE SHOWN**

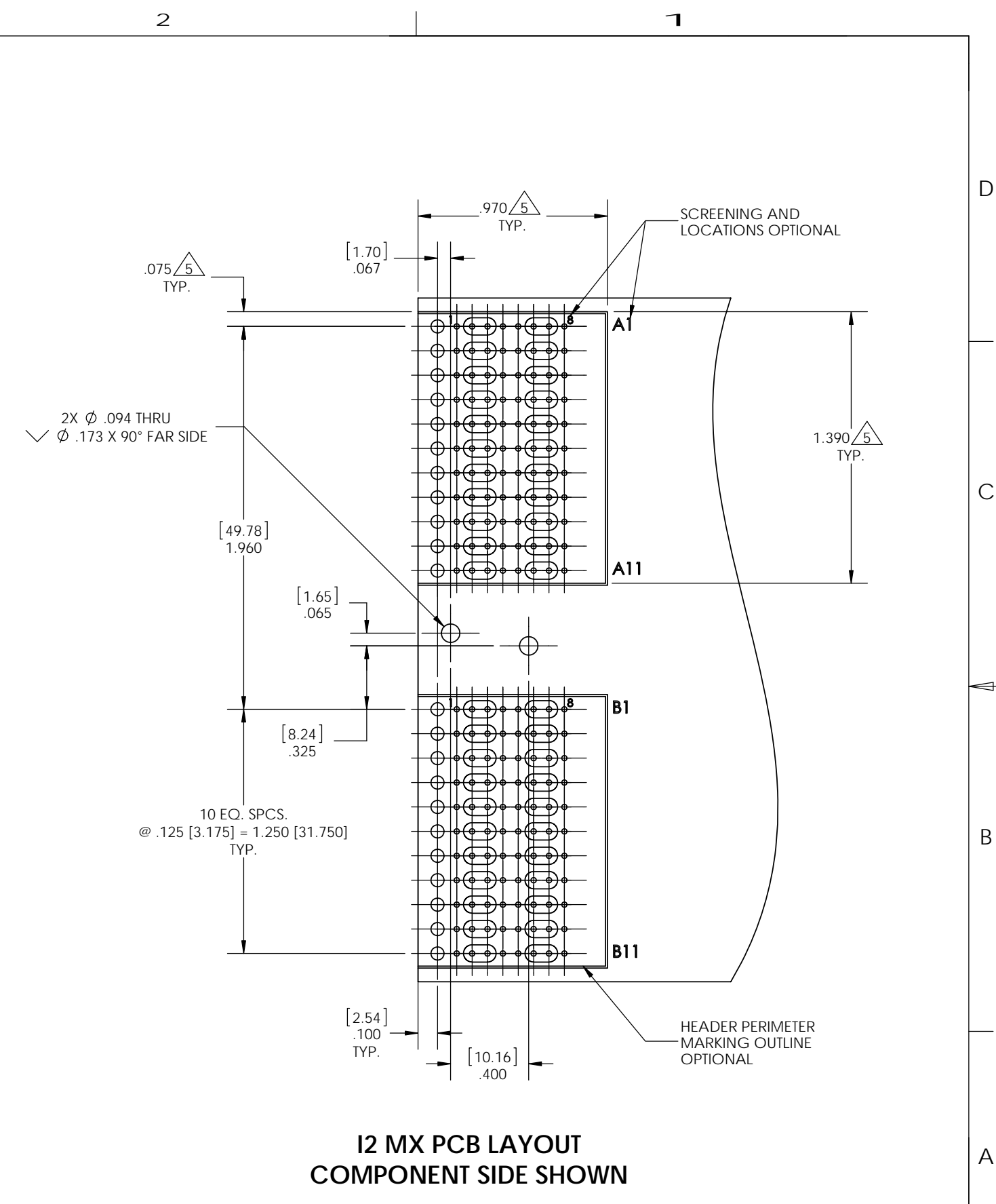

**12 MX PCB LAYOUT
COMPONENT SIDE SHOWN**

△ 5 HEADER PERIMETER MARKING (OPTIONAL). INTERNAL AREA REPRESENTS MINIMUM REQUIRED COMPONENT FREE ZONE.

NOTES:

DO NOT SCALE DRAWING

CUSTOMER DRAWING - CUSTOMER DRAWING - CUSTOMER DRAWING			
THE INFORMATION CONTAINED HEREIN IS THE EXCLUSIVE PROPERTY OF VIRGINIA PANEL CORPORATION AND IS SUBMITTED FOR USE BY THE CUSTOMER ONLY. THE DATA SHALL NOT BE DUPLICATED, USED, OR DISCLOSED IN WHOLE OR IN PART FOR ANY PURPOSE OTHER THAN TO MAINTAIN THE EQUIPMENT PROVIDED.		DWG.NO. 610151104	REV A
SCALE 3:2	CAGE CODE 18117	SHEET 2 OF 2	