

Solid Tantalum Chip Capacitors

TANTAMOUNT® Conformal Coated, Maximum CV, Low ESR



FEATURES

- New extended range offerings.
- Large capacitance rating range.
- Lowest ESR for a surface mount tantalum chip capacitor.
- 100 % surge current conditioning for C, D and R cases.
- Terminations: Tin (2) standard
- 8 mm, 12 mm tape and reel packaging available per EIA 481-1 and reeling per IEC 286-3. 7" [178 mm] standard. 13" [330 mm] available.
- Case code compatibility with EIA 535BAAE and CECC30801 molded chips.



RoHS*
COMPLIANT

PERFORMANCE/ELECTRICAL CHARACTERISTICS

Operating Temperature: - 55 °C to + 85 °C.
(To + 125 °C with voltage derating.)

Capacitance Range: 1.0 μF to 1500 μF

Capacitance Tolerance: ± 10 %, ± 20 % standard

Voltage Rating: 4 WVDC to 50 WVDC

Equivalent Series Resistance: ESR readings measured at 100 kHz, + 25 °C from 3500 milliohm to 30 milliohm.

ORDERING INFORMATION						
594D TYPE	477 CAPACITANCE	X0 CAPACITANCE TOLERANCE	004 DC VOLTAGE RATING AT + 85 °C	R CASE CODE	2 TERMINATION	T PACKAGING
	This is expressed in picofarads. The first two digits are the significant figures. The third is the number of zeros to follow.	X0 = ± 20 % X9 = ± 10 %	This is expressed in volts. To complete the three-digit block, zeros precede the voltage rating. A decimal point is indicated by an "R" (6R3 = 6.3 volts).	See Ratings and Case Codes Table.	2 = 100 % Tin 4 = Gold Plated 7 = Hot Solder Dipped 8 = Solder Plated (60/40) Special Order	T = Tape and Reel 7" [178 mm] Reel W = 13" [330 mm] Reel See Tape and Reel Specifications.
Note: Preferred Tolerance and reel sizes are in bold. We reserve the right to supply higher voltage ratings and tighter capacitance tolerance capacitors in the same case size. Voltage substitutions will be marked with the higher voltage rating.						

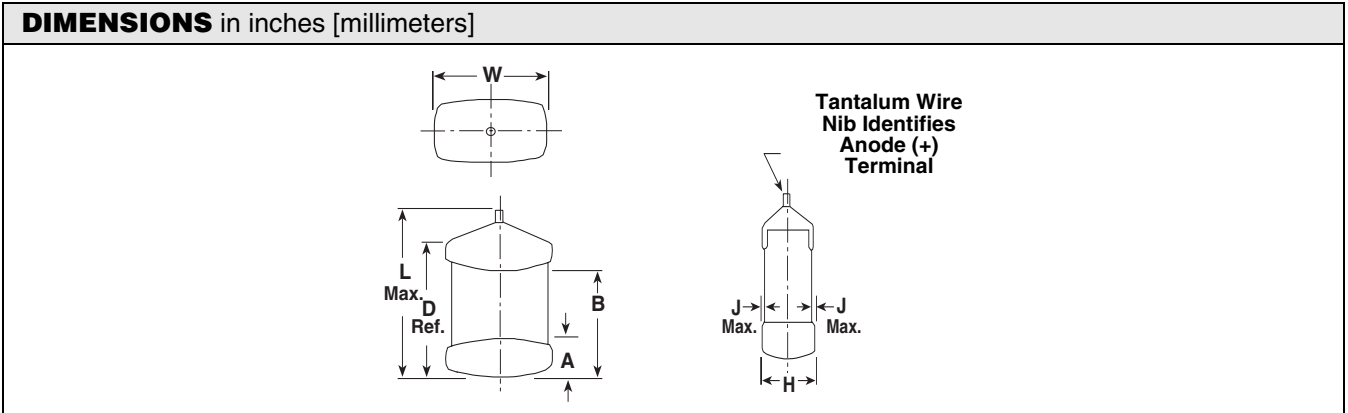

CASE CODE	L (Max.)	W	H	A	B	D (Ref.)	J (Max.)
B	0.158 [4.0]	0.110 + 0.012 - 0.016 [2.8 + 0.3 - 0.4]	0.075 + 0.012 - 0.024 [1.9 + 0.3 - 0.6]	0.031 ± 0.012 [0.80 ± 0.30]	0.097 ± 0.016 [2.5 ± 0.4]	0.138 [3.5]	0.004 [0.1]
C	0.281 [7.1]	0.126 ± 0.012 [3.2 ± 0.3]	0.098 ± 0.012 [2.5 ± 0.3]	0.051 ± 0.012 [1.3 ± 0.30]	0.180 ± 0.024 [4.6 ± 0.6]	0.236 [6.0]	0.004 [0.1]
D	0.293 [7.5]	0.170 ± 0.012 [4.3 ± 0.3]	0.110 ± 0.012 [2.8 ± 0.3]	0.051 ± 0.012 [1.3 ± 0.30]	0.180 ± 0.024 [4.6 ± 0.6]	0.253 [6.4]	0.004 [0.1]
R	0.283 [7.2]	0.235 ± 0.012 [6.0 ± 0.3]	0.136 ± 0.012 [3.5 ± 0.3]	0.051 ± 0.012 [1.3 ± .30]	0.180 ± 0.024 [4.6 ± 0.6]	0.243 [6.2]	0.004 [0.1]

Note: The anode termination (D less B) will be a minimum of 0.012" [0.3 mm].

* Pb containing terminations are not RoHS compliant, exemptions may apply



Solid Tantalum Chip Capacitors
TANTAMOUNT®, Conformal Coated,
Maximum CV, Low ESR

Vishay Sprague

RATINGS AND CASE CODES																	
µF	4 V		6.3 V		10 V		16 V		20 V		25 V		35 V		50 V		
	Std.	Ext.	Std.	Ext.	Std.	Ext.	Std.	Ext.	Std.	Ext.	Std.	Ext.	Std.	Ext.	Std.	Ext.	
1.0																B	
1.5																	
2.2														B			
3.3												B					
4.7									B					B	C		
6.8									B				C		D		
10										B		B					
15					B		B				C		D	C	R		
22			B						C	B		C		D			
33	B					B	C	B			D		R				
47						B	C	B	D	C		D		R			
68					C	B	D	C			R	D					
100		B*		B	C	B	D	C		D		R					
120			C						R								
150	C	B			D	C		D									
180							R										
220			D	C		C/D		R									
270	D																
330		C*		C/D	R	D		R									
390			R														
470	R	C	R	D		R											
560																	
680		D		R		R											
1000				R													
1500		R															

* Preliminary Values, contact factory for availability.

STANDARD / EXTENDED RATINGS						
CAPACITANCE (µF)	CASE CODE	PART NUMBER	Max. DCL at + 25 °C (µA)	Max. DF at + 25 °C 120 Hz (%)	Max. ESR at + 25 °C 100 kHz (Ohms)	Max. RIPPLE 100 kHz I _{rms} (Amps)
4 WVDC AT + 85 °C, SURGE = 5.2 V . . . 2.7 WVDC AT + 125 °C, SURGE = 3.4 V						
33	B	594D336X_004B2T	1.3	6	0.38	0.47
100*	B*	594D107X_004B2T*	4.0*	8*	0.30*	0.53*
150	B	594D157X_004B2T	6.0	8	0.25	0.58
150	C	594D157X_004C2T	6.0	8	0.08	1.17
270	D	594D277X_004D2T	10.8	8	0.06	1.58
330*	C*	594D337X_004C2T*	13.2*	8*	0.08*	1.17*
470	C	594D477X_004C2T	18.8	10	0.075	1.21
470	R	594D477X_004R2T	18.8	10	0.045	2.36
680	D	594D687X_004D2T	27.2	12	0.060	1.58
1500	R	594D158X_004R2T	60.0	20	0.030	2.89
6.3 WVDC AT + 85 °C, SURGE = 8 V . . . 4 WVDC AT + 125 °C, SURGE = 5 V						
22	B	594D226X_6R3B2T	1.4	6	0.380	0.47
100	B	594D107X_6R3B2T	6.3	6	0.250	0.58
120	C	594D127X_6R3C2T	7.6	8	0.085	1.48
220	C	594D227X_6R3C2T	13.9	8	0.080	1.37
220	D	594D227X_6R3D2T	13.9	8	0.065	1.52
330	C	594D337X_6R3C2T	20.8	8	0.080	1.17
330	D	594D337X_6R3D2T	20.8	8	0.060	1.58
390	R	594D397X_6R3R2T	24.6	8	0.045	2.36
470	D	594D477X_6R3D2T	29.6	10	0.060	1.58
470	R	594D477X_6R3R2T	29.6	10	0.050	2.24
680	R	594D687X_6R3R2T	42.8	12	0.045	2.36
1000	R	594D108X_6R3R2T	63.0	16	0.030	2.89

*Preliminary values, contact factory for availability. For 10 % tolerance, specify "9"; for 20 % tolerance, change to "0". **Extended Range ratings in bold print.**



STANDARD / EXTENDED RATINGS							
CAPACITANCE (μ F)	CASE CODE	PART NUMBER	Max. DCL at + 25 °C (μ A)	Max. DF at + 25 °C 120 Hz (%)	Max. ESR at + 25 °C 100 kHz (Ohms)	Max. RIPPLE 100 kHz I_{rms} (Amps)	
10 WVDC AT + 85 °C, SURGE = 13 V . . . 7 WVDC AT + 125 °C, SURGE = 8 V							
15	B	594D156X_010B2T	1.5	6	0.50	0.41	
33	B	594D336X_010B2T	3.3	6	0.50	0.41	
47	B	594D476X_010B2T	4.7	6	0.40	0.46	
68	B	594D686X_010B2T	6.8	6	0.350	0.49	
68	C	594D686X_010C2T	6.8	6	0.100	1.05	
100	B	594D107X_010B2T	10	12	0.250	0.57	
100	C	594D107X_010C2T	10	8	0.095	1.08	
150	C	594D157X_010C2T	15	8	0.090	1.11	
150	D	594D157X_010D2T	15	8	0.075	1.41	
220	C	594D227X_010C2T	22	8	0.100	1.05	
220	D	594D227X_010D2T	22	8	0.065	1.52	
330	D	594D337X_010D2T	33	8	0.065	1.52	
330	R	594D337X_010R2T	33	8	0.045	2.36	
470	R	594D477X_010R2T	47	10	0.045	2.36	
680	R	594D687X_010R2T	68	14	0.045	2.36	
16 WVDC AT + 85 °C, SURGE = 20 V . . . 10 WVDC AT + 125 °C, SURGE = 12 V							
15	B	594D156X_016B2T	2.4	6	0.55	0.39	
33	B	594D336X_016B2T	5.3	6	0.500	0.41	
33	C	594D336X_016C2T	5.3	6	0.150	0.86	
47	B	594D476X_016B2T	7.5	6	0.72	0.34	
47	C	594D476X_016C2T	7.5	6	0.110	1.00	
68	C	594D686X_016C2T	10.9	6	0.123	0.95	
68	D	594D686X_016D2T	10.9	6	0.095	1.26	
100	C	594D107X_016C2T	16	8	0.080	1.17	
100	D	594D107X_016D2T	16	8	0.075	1.41	
150	D	594D157X_016D2T	24	8	0.085	1.33	
180	R	594D187X_016R2T	28.8	8	0.055	2.13	
220	R	594D227X_016R2T	35.2	8	0.055	2.13	
330	R	594D337X_016R2T	52.8	8	0.055	2.13	
20 WVDC AT + 85 °C, SURGE = 26 V . . . 13 WVDC AT + 125 °C, SURGE = 16 V							
4.7	B	594D475X_020B2T	0.9	6	0.90	0.31	
6.8	B	594D685X_020B2T	1.4	6	0.90	0.31	
10	B	594D106X_020B2T	2.0	6	0.85	0.32	
22	B	594D226X_020B2T	4.4	6	0.60	0.38	
22	C	594D226X_020C2T	4.4	6	0.150	0.86	
47	C	594D476X_020C2T	9.4	6	0.140	0.89	
47	D	594D476X_020D2T	9.4	6	0.095	1.26	
100	D	594D107X_020D2T	20	8	0.085	1.33	
120	R	594D127X_020R2T	24	8	0.080	1.77	
25 WVDC AT + 85 °C, SURGE = 32 V . . . 17 WVDC AT + 125 °C, SURGE = 20 V							
3.3	B	594D335X_025B2T	0.8	6	1.50	0.24	
10	B	594D106X_025B2T	2.5	6	0.900	0.31	
15	C	594D156X_025C2T	3.8	6	0.220	0.70	
22	C	594D226X_025C2T	5.5	6	0.200	0.74	
33	D	594D336X_025D2T	8.3	6	0.130	1.05	
47	D	594D476X_025D2T	11.8	6	0.130	1.07	
68	D	594D686X_025D2T	17	6	0.150	1.00	
68	R	594D686X_025R2T	17	6	0.095	1.60	
100	R	594D107X_025R2T	25	8	0.090	1.67	
35 WVDC AT + 85 °C, SURGE = 46 V . . . 23 WVDC AT + 125 °C, SURGE = 28 V							
2.2	B	594D225X_035B2T	0.8	6	1.70	0.22	
4.7	B	594D475X_035B2T	1.6	6	1.40	0.25	
6.8	C	594D685X_035C2T	2.4	6	0.43	0.51	
15	C	594D156X_035C2T	5.3	6	0.40	0.52	
15	D	594D156X_035D2T	5.3	6	0.27	0.75	
22	D	594D226X_035D2T	7.7	6	0.27	0.75	
33	R	594D336X_035R2T	11.6	6	0.20	1.12	
47	R	594D476X_035R2T	16.6	6	0.20	1.12	
50 WVDC AT + 85 °C, SURGE = 65 V . . . 33 WVDC AT + 125 °C, SURGE = 38 V							
1.0	B	594D105X_050B2T	0.5	4	3.5	0.16	
4.7	C	594D475X_050C2T	2.4	6	1.0	0.33	
6.8	D	594D685X_050D2T	3.4	6	.45	0.58	
15	R	594D156X_050R2T	7.5	6	.35	0.85	

*Preliminary values, contact factory for availability. For 10 % tolerance, specify "9"; for 20 % tolerance, change to "0". **Extended Range ratings in bold print.**



Solid Tantalum Chip Capacitors
TANTAMOUNT®, Conformal Coated,
Maximum CV, Low ESR

Vishay Sprague

TYPICAL CURVES @ + 25 °C, IMPEDANCE AND ESR VS. FREQUENCY

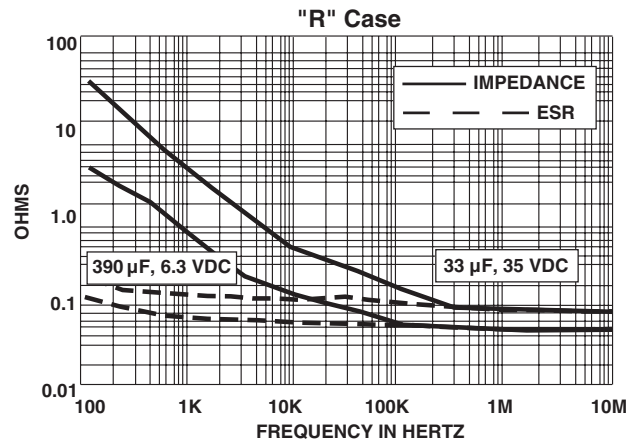
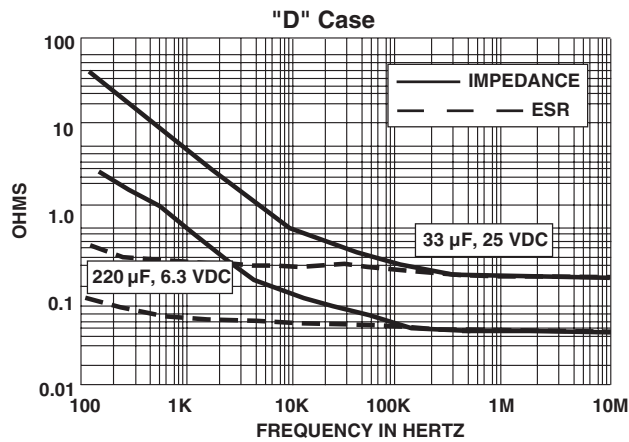
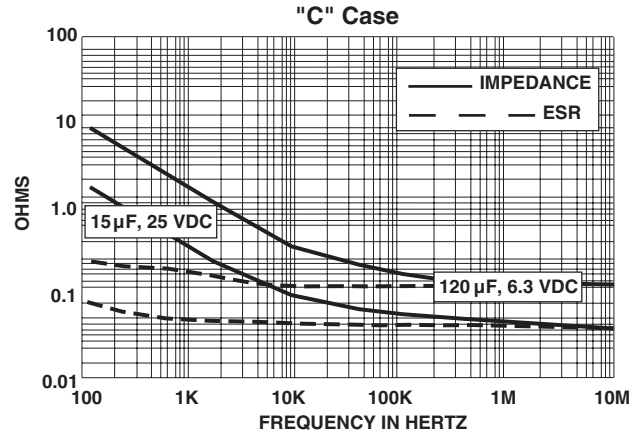
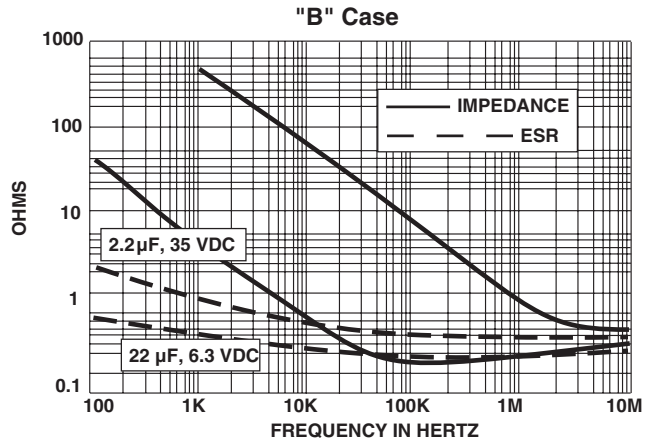



PERFORMANCE CHARACTERISTICS

- 1. **Operating Temperature:** Capacitors are designed to operate over the temperature range of - 55 °C to + 85 °C.
- 1.1 Capacitors may be operated to + 125 °C with voltage derating to two-thirds the + 85 °C rating.

+ 85 °C RATING		+ 125 °C RATING	
Working Voltage (V)	Surge Voltage (V)	Working Voltage (V)	Surge Voltage (V)
4.0	5.2	2.7	3.4
6.3	8.0	4.0	5.0
10	13	7.0	8.0
16	20	10	12
20	26	13	16
25	32	17	20
35	46	23	28
50	65	33	38

- 2. **DC Working Voltage:** The DC working voltage is the maximum operating voltage for continuous duty at the rated temperature.
- 3. **Surge Voltage:** The surge DC rating is the maximum voltage to which the capacitors may be subjected under any conditions, including transients and peak ripple at the highest line voltage.
- 3.1 **Surge Voltage Test:** Capacitors shall withstand the surge voltage applied in series with a 33 ohm ± 5 % resistor at the rate of one-half minute on, one-half minute off, at + 85 °C, for 1000 successive test cycles.
- 3.2 Following the surge voltage test, the dissipation factor and the leakage current shall meet the initial requirements; the capacitance shall not have changed more than ± 10 %.
- 4. **Capacitance Tolerance:** The capacitance of all capacitors shall be within the specified tolerance limits of the normal rating.
- 4.1 Capacitance measurements shall be made by means of polarized capacitance bridge. The polarizing voltage shall be of such magnitude that there shall be no reversal of polarity due to the AC component. The maximum voltage applied to capacitors during measurement shall be 2 volts rms at 120 Hz at + 25 °C. If the AC voltage applied is less than one-half volt rms, no DC bias is required. Accuracy of the bridge shall be within ± 2 %.
- 5. **Capacitance Change With Temperature:** The capacitance change with temperature shall not exceed the following percentage of the capacitance measured at + 25 °C:

- 55 °C	+ 85 °C	+ 125 °C
- 10 %	+ 10 %	+ 12 %

- 6. **Dissipation Factor:** The dissipation factor, determined from the expression $2\pi fRC$, shall not exceed values listed in the Standard Ratings Table.
- 6.1 Measurements shall be made by the bridge method at, or referred to, a frequency of 120 Hz and a temperature of + 25 °C.
- 7. **Leakage Current:** Capacitors shall be stabilized at the rated temperature for 30 minutes. Rated voltage shall be applied to capacitors for 5 minutes using a steady source of power (such as a regulated power supply) with 1000 ohm resistor connected in series with the capacitor under test to limit the charging current. Leakage current shall then be measured.

Note that the leakage current varies with temperature and applied voltage. See graph below for the appropriate adjustment factor.

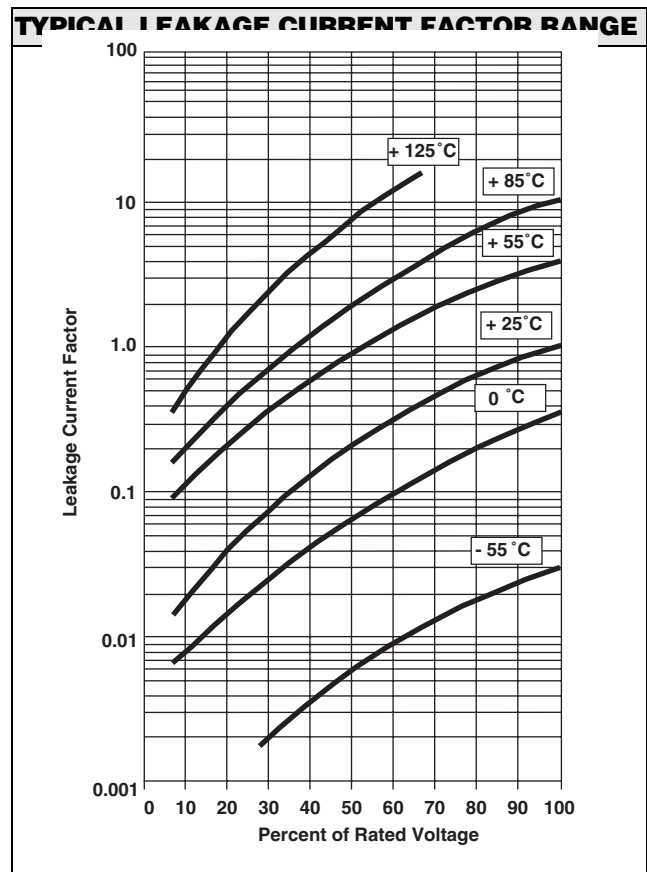

- 7.1 **At + 25 °C,** the leakage current shall not exceed the value listed in the Standard Ratings Table.
- 7.2 **At + 85 °C,** the leakage current shall not exceed 10 times the value listed in the Standard Ratings Table.
- 7.3 **At + 125 °C,** the leakage current shall not exceed 12 times the value listed in the Standard Ratings Table.



Solid Tantalum Chip Capacitors
TANTAMOUNT®, Conformal Coated,
Maximum CV, Low ESR

Vishay Sprague

PERFORMANCE CHARACTERISTICS (Continued)

- 8. **ESR (Equivalent Series Resistance)**
Measurement shall be made by the bridge method at a frequency of 100kHz and a temperature of + 25°C.
- 8.1 The equivalent Series Resistance shall not exceed the value listed in the Standard Ratings Table.
- 9. **Life Test:** Capacitors shall withstand rated DC voltage applied at + 85°C or two-thirds rated voltage applied at + 125°C for 2000 hours.
- 9.1 Following the life test, the dissipation factor shall meet the initial requirement; the capacitance change shall not exceed ± 10%; the leakage current shall not exceed 125 % of the initial requirement.
- 10. **Humidity Test:** Capacitors shall withstand 1000 hours at + 40 °C, 90 % to 95 % relative humidity, with no voltage applied.
- 10.1 Following the humidity test, capacitance change shall not exceed ± 10 % of the initial value, dissipation factor shall not exceed 150 % of the initial requirement; leakage current shall not exceed 200% of the initial requirement at + 25 °C.
- 11. **Solderability:** Capacitors will meet the solderability requirements of ANSI/J-STD-002, Test B, Category 3.
- 12. **Resistance to Soldering Heat:** Capacitors mounted on a substrate will withstand + 260 °C for 5 seconds.
- 12.1 Following the resistance to soldering heat test, capacitance, dissipation factor and DC leakage current shall meet the initial requirement.
- 13. **Marking:** The small body area of these capacitors does not allow elaborate marking schemes. All required information is present on the carton or package in which the parts are shipped; in addition, part number, quantity and date code are indicated on the reels.
- 14. **Terminal Strength:** per IEC-384-3, minimum of 5N shear force.
- 15. **Environmental:** Mercury, CFC and ODS materials are not used in the manufacture of these capacitors.
- 16. **Flammability:** Encapsulant materials meet UL94 V0.
- 17. **Capacitor Failure Mode:** The predominant failure mode for solid tantalum capacitors is increased leakage current resulting in a shorted circuit. Capacitor failure may result from excess forward or reverse DC voltage, surge current, ripple current, thermal shock or excessive temperature.

The increase in leakage current is caused by a breakdown of the Ta₂O₅ dielectric. For additional information on leakage failure of solid tantalum chip capacitors, refer to Vishay Sprague technical paper: "Leakage Failure Mode in Solid Tantalum Chip Capacitors."

GUIDE TO APPLICATION

- 1. **Recommended rated working voltage guidelines:** (-55 °C to + 85 °C)

Standard Conditions, for example; output filters

Capacitor Voltage Rating (V)	Operating Voltage (V)
4.0	2.5
6.3	3.6
10	6.0
16	10
20	12
25	15
35	24
50	28

Severe Conditions, for example; input filters

Capacitor Voltage Rating (V)	Operating Voltage (V)
4.0	2.5
6.3	3.3
10	5.0
16	8.0
20	10
25	12
35	15
50	24

- 2. **A-C Ripple Current:** The maximum allowable ripple current shall be determined from the formula:

$$I_{rms} = \sqrt{\frac{P}{R_{ESR}}}$$

where,

- P = Power Dissipation in Watts at + 25 °C as given in the table in Paragraph Number 6 (Power Dissipation)
- R_{ESR} = The capacitor Equivalent Series Resistance at the specified frequency.

- 3. **A-C Ripple Voltage:** The maximum allowable ripple voltage shall be determined from the formula:

$$V_{rms} = Z \sqrt{\frac{P}{R_{ESR}}}$$

or, from the formula:

$$V_{rms} = I_{rms} \times Z$$

where,

- P = Power Dissipation in Watts at + 25 °C as given in the table in Paragraph Number 6 (Power Dissipation).
- R_{ESR} = The capacitor Equivalent Series Resistance at the specified frequency.
- Z = The capacitor impedance at the specified frequency.



GUIDE TO APPLICATION (Continued)

- 3.1 The sum of the peak AC voltage plus the applied DC voltage shall not exceed the DC voltage rating of the capacitor.
- 3.2 The sum of the negative peak AC voltage plus the applied DC voltage shall not allow a voltage reversal exceeding 10 % of the DC working voltage at + 25 °C.
- 4. **Reverse Voltage:** These capacitors are capable of withstanding peak voltages in the reverse direction equal to 10 % of the DC rating at + 25 °C and 5 % of the DC rating at + 85 °C.
- 5. **Temperature Derating:** If these capacitors are to be operated at temperatures above + 25 °C, the permissible rms ripple current or voltage shall be calculated using the derating factors as shown:

Temperature	Derating Factor
+ 25 °C	1.0
+ 85 °C	0.9
+ 125 °C	0.4

- 6. **Power Dissipation:** Power dissipation will be affected by the heat sinking capability of the mounting surface. Non-sinusoidal ripple current may produce heating effects which differ from those shown. It is important that the equivalent Irms value be established when calculating permissible operating levels. (Power dissipation calculated using + 25 °C temperature rise.)

Case Code	Maximum Permissible Power Dissipation at + 25 °C (watts) in Free Air
B	0.085
C	0.110
D	0.150
R	0.250

- 7. **Printed Circuit Board Materials:** The capacitors are compatible with most commonly used printed circuit board materials (alumina substrates, FR4, FR5, G10, PTFE-fluorocarbon and porcelainized steel). If your desired board material is not shown there please contact the Tantalum Marketing Department for assistance in determining compatibility.

8. Attachment:

- 8.1 **Solder Paste:** The recommended thickness of the solder paste after application is 0.007" ± 0.001" [0.178 mm ± 0.025 mm]. Care should be exercised in selecting the solder paste. The metal purity should be as high as practical. The flux (in the paste) must be active enough to remove the oxides formed on the metallization prior to the exposure to soldering heat.

- 8.2 **Soldering:** Capacitors can be attached by conventional soldering techniques, vapor phase convection, infrared reflow, wave soldering and hot plate methods. The Soldering Profile charts show typical recommended time/temperature conditions for soldering. Preheating is recommended to reduce thermal stress. The recommended maximum preheat rate is 2 °C per second. Attachment with a soldering iron is not recommended due to the difficulty of controlling temperature and time at temperature. The soldering iron must never come in contact with the capacitor.

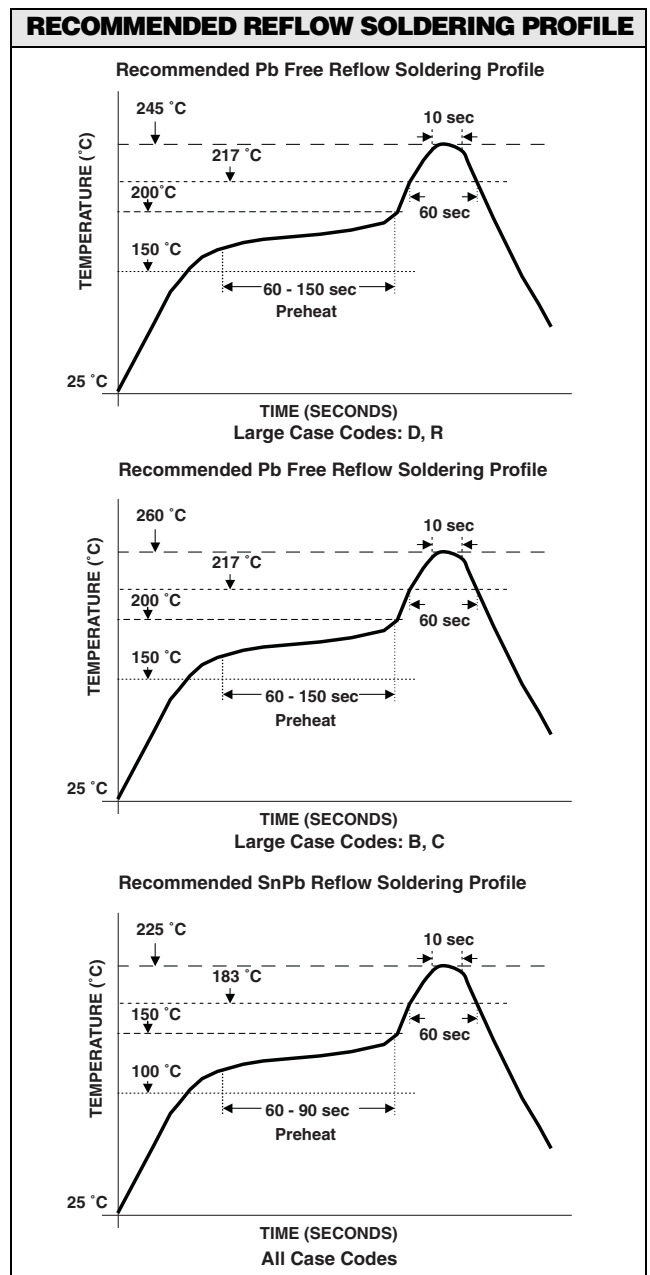

Solid Tantalum Chip Capacitors
TANTAMOUNT®, Conformal Coated,
 Maximum CV, Low ESR

Vishay Sprague

GUIDE TO APPLICATION (Continued)

9. Recommended Mounting Pad Geometries: The nib must have sufficient clearance to avoid electrical contact with other components. The width dimension indicated is the same as the maximum width of the capacitor. This is to minimize lateral movement.
10. Cleaning (Flux Removal) After Soldering: The 594D is compatible with all commonly used solvents such as TES, TMS, Prelete, Chloroethane, Terpene and aqueous cleaning media. However, CFC/ODS products are not used in the production of these devices and are not recommended. Solvents containing methylene chloride or other epoxy solvents should be avoided since these will attack the epoxy encapsulation material.

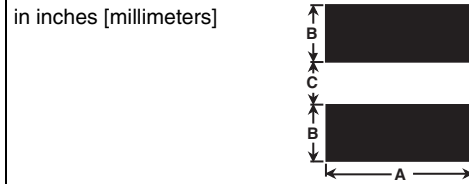
REFLOW SOLDER PADS*

* Pads for B, C and D case codes are otherwise pad compatible with Type 293D, B, C and D case codes respectively.

CASE CODE	WIDTH (A)	PAD METALLIZATION (B)	SEPARATION (C)
B	0.120 [3.0]	0.065 [1.7]	0.065 [1.7]
C	0.136 [3.5]	0.090 [2.3]	0.120 [3.1]
D	0.180 [4.6]	0.090 [2.3]	0.145 [3.7]
R	0.245 [6.3]	0.090 [2.3]	0.145 [3.7]

TAPE AND REEL PACKAGING in inches [millimeters]

Standard orientation is with the cathode (-) nearest to the sprocket holes per EIA-481-1 and IEC 286-3.

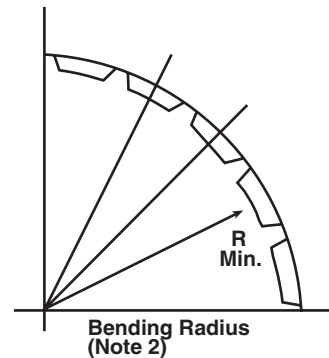
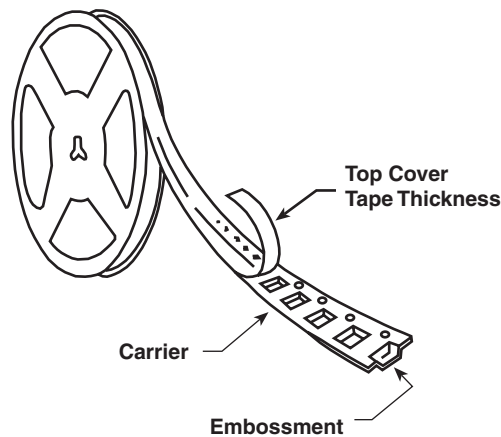

Case Code	Tape Width	Component Pitch	Units Per Reel	
			7" [178] Reel	13" [330] Reel
B	12 mm	4 mm	2000	8000
C	12 mm	8 mm	500	3000
D	12 mm	8 mm	500	2500
R	12 mm	8 mm	600	-

TAPE AND REEL PACKAGING in inches [millimeters]

Note: Metric dimensions will govern. Dimensions in inches are rounded and for reference only.

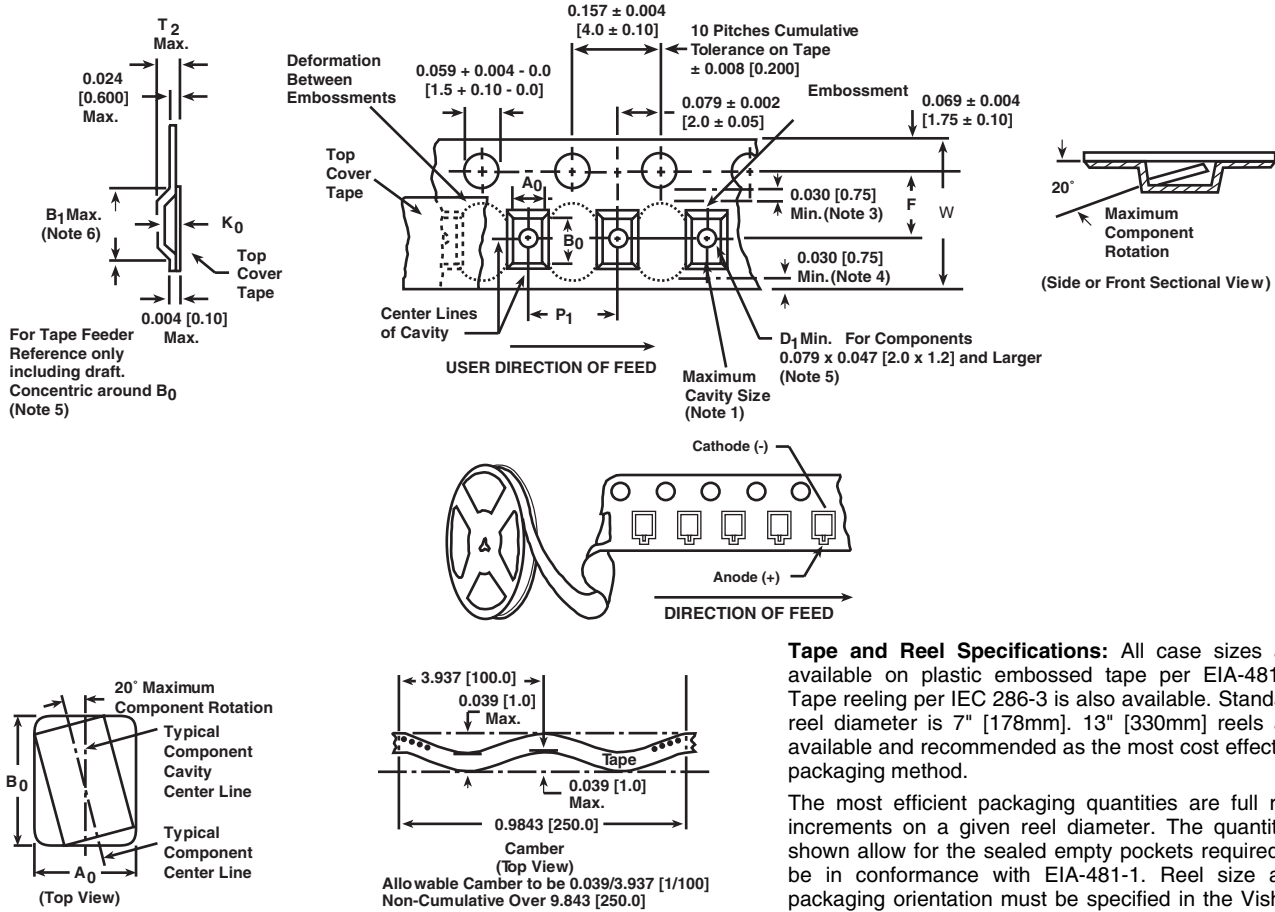

Tape and Reel Specifications: All case sizes are available on plastic embossed tape per EIA-481-1. Tape reeling per IEC 286-3 is also available. Standard reel diameter is 7" [178mm]. 13" [330mm] reels are available and recommended as the most cost effective packaging method. The most efficient packaging quantities are full reel increments on a given reel diameter. The quantities shown allow for the sealed empty pockets required to be in conformance with EIA-481-1. Reel size and packaging orientation must be specified in the Vishay Sprague part number.

Tape Size	B ₁ (Max.) (Note 6)	D ₁ (Min.) (Note 5)	F	P ₁	R (Min.) (Note 2)	T ₂ (Max.)	W	A ₀ B ₀ K ₀
12 mm	0.323 [8.2]	0.059 [1.5]	0.217 ± 0.002 [5.5 ± 0.05]	0.157 ± 0.004 [4.0 ± 0.10]	1.181 [30.0]	0.256 [6.5]	0.472 ± 0.012 [12.0 ± 0.30]	(Note 1)
12 mm Double Pitch	0.323 [8.2]	0.059 [1.5]	0.453 ± 0.004 [11.5 ± 0.03]	0.315 ± 0.004 [8.0 ± 0.10]	1.181 [30.0]	0.256 [6.5]	0.945 ± 0.012 [24.0 ± 0.30]	

Notes:

- A₀B₀K₀ are determined by the maximum dimensions to the ends of the terminals extending from the component body and/or the body dimensions of the component. The clearance between the ends of the terminals or body of the component to the sides and depth of the cavity (A₀B₀K₀) must be within 0.002" [0.05 mm] minimum and 0.020" [0.50 mm] maximum. The clearance allowed must also prevent rotation of the component within the cavity of not more than 20 degrees.
- Tape with components shall pass around radius "R" without damage. The minimum trailer length may require additional length to provide R minimum for 12 mm embossed tape for reels with hub diameters approaching N minimum.
- This dimension is the flat area from the edge of the sprocket hole to either the outward deformation of the carrier tape between the embossed cavities or to the edge of the cavity whichever is less.
- This dimension is the flat area from the edge of the carrier tape opposite the sprocket holes to either the outward deformation of the carrier tape between the embossed cavity or to the edge of the cavity whichever is less.
- The embossment hole location shall be measured from the sprocket hole controlling the location of the embossment. Dimensions of embossment location and hole location shall be applied independent of each other.
- B₁ dimension is a reference dimension for tape feeder clearance only.