

Precision Low TCR High Temperature Thin Film Resistor, Surface Mount Chip, ± 5 ppm/°C TCR, 0.02 % Tolerance

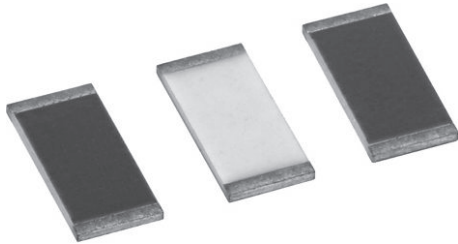

Vishay's proven precision thin film wraparound resistors will meet your exact requirements. These resistors are ideal for use in oil industry precision applications requiring low noise, long term stability under high temperature, ultra low temperature coefficient of resistance, and low voltage coefficient. The chip resistors are available in any resistance ohmic value in the range specified below.

CONSTRUCTION

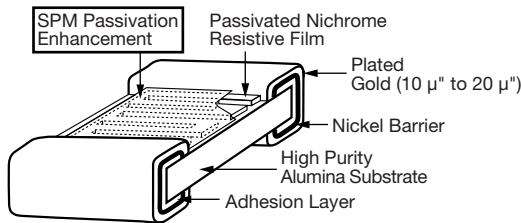

FEATURES

- PLTT0603 case size is qualified to AEC-Q200 for automotive applications
- -55 °C to 215 °C operating temperature range
- TCR of ± 5 ppm/°C standard
- Tolerances to ± 0.02 %
- Anti corrosion resistant film with (SPM) special passivation method
- Stable film and performance characteristics
- 0.5 % max. at 2000 h, 215 °C, 25 % rated power
- Non-standard resistance values available
- Very low noise and voltage coefficient (< -30 dB, 0.1 ppm/V)
- UL 94 V-0 flame resistant
- Gold terminations (10 μ " to 20 μ ")
- Material categorization: for definitions of compliance please see www.vishay.com/doc?99912



TYPICAL PERFORMANCE

	ABSOLUTE
TCR	5
TOL.	0.02

STANDARD ELECTRICAL SPECIFICATIONS

TEST	SPECIFICATIONS	CONDITIONS
Material	Passivated nichrome	-
Resistance Range	50 Ω to 3 M Ω	-
TCR: Absolute	± 5 ppm/°C	-55 °C to +215 °C
Tolerance: Absolute	± 0.1 % to ± 0.02 %	+25 °C
Stability: Absolute	$\Delta R \pm 0.5$ %	2000 h at 215 °C, 25 % rated power
Stability: Ratio	-	-
Voltage Coefficient	± 0.1 ppm/V (typical)	-
Working Voltage	100 V to 200 V	-
Operating Temperature Range	-55 °C to +215 °C	-
Storage Temperature Range	-55 °C to +215 °C	-
Noise	< -35 dB (typical)	-
Shelf Life Stability: Absolute	$\Delta R \pm 0.01$ %	1 year at +25 °C

COMPONENT RATINGS

CASE SIZE	POWER RATING AT 70 °C (mW)	WORKING VOLTAGE (V)	RESISTANCE RANGE (Ω)
0603	150	75	75 to 130K
0805	250	100	250 to 260K
1206	400	200	500 to 775K
2010	800	200	500 to 2M
2512	1000	200	500 to 3M

Note

- Consult factory for additional case size

DIMENSIONS in inches						
CASE SIZE	TERM	L	W	T	D	E
0603	G	0.064 ± 0.006	0.032 ± 0.005	0.015 to 0.033	0.012 ± 0.005	0.015 ± 0.005
0805	G	0.080 ± 0.006	0.050 ± 0.005	0.015 to 0.033	0.016 ± 0.008	0.015 ± 0.005
1206	G	0.126 ± 0.008	0.063 ± 0.005	0.015 to 0.033	0.020 + 0.005/- 0.010	0.020 + 0.005/- 0.010
2010	G	0.209 ± 0.009	0.098 ± 0.005	0.015 to 0.033	0.020 ± 0.005	0.020 ± 0.005
2512	G	0.259 ± 0.009	0.124 ± 0.005	0.015 to 0.033	0.020 ± 0.005	0.020 ± 0.005

ENVIRONMENTAL TESTS - MIL-PRF-55342		
ENVIRONMENTAL TEST	CONDITIONS	TYPICAL VISHAY PERFORMANCE
Thermal Shock	MIL-STD-202 method 107 Cond F, -65 °C to +150 °C	± 0.02 %
Short Time Overload	MIL-PRF-55342 Para 4.8.6, 2.5x rated working voltage	± 0.01 %
Low Temperature Operation	MIL-PRF-55342 Para 4.8.5, -65 °C	± 0.01 %
Resistance to Soldering Heat	MIL-STD-202 method 210	± 0.01 %
Moisture Resistance	MIL-STD-202 method 106, no power applied	± 0.02 %
High Temperature Exposure	MIL-PRF-55342 Para 4.8.7, at 150 °C for 100 h	± 0.02 %
Life	MIL-STD-202 method 108, 25 % rated power for 2000 h at 215 °C	± 0.50 %
TCR	MIL-STD-202 method 304	± 5 ppm/°C

ENVIRONMENTAL TESTS - AEC-Q200 PLTT0603 Case Size Only		
ENVIRONMENTAL TEST	CONDITIONS	TYPICAL VISHAY PERFORMANCE
High temperature storage	MIL-STD-202 method 108, 1000 h at 125 °C	± 0.10 %
Temperature cycling	JESD22 method JA-104, 1000 cycles, -55 °C to +155 °C	± 0.25 %
Moisture resistance	MIL-STD-202 method 106, no power applied	± 0.10 %
Biased humidity	MIL-STD-202 method 103, 1000 h at 85 °C, 85 % RH, 10 % rated power	± 0.20 %
Life	MIL-STD-202 method 108, 1000 h at 175 °C, 50 % rated power	± 0.50 %
Mechanical shock	MIL-STD-202 method 213, condition C	± 0.02 %
Vibration	MIL-STD-202 method 204, 10 Hz to 2 kHz	± 0.02 %
Resistance to soldering heat	MIL-STD-202 method 210, condition B	± 0.02 %
Electrostatic discharge	AEC-Q200-002, human body (< 1 kΩ: 1 kV; > 1 kΩ: 2 kV)	< 1 kΩ: 1 kV; > 1 kΩ: 2 kV
Solderability	MIL-STD-883 method 2003 para 2.3.1 and J-STD-002	Pass
TCR	MIL-STD-202 method 304	± 5 ppm /°C
Die shear	MIL-PRF-55342, 0.5 kg for 30 s minimum	Pass
Flame retardance	AEC-Q200-001 para 4.0	Pass

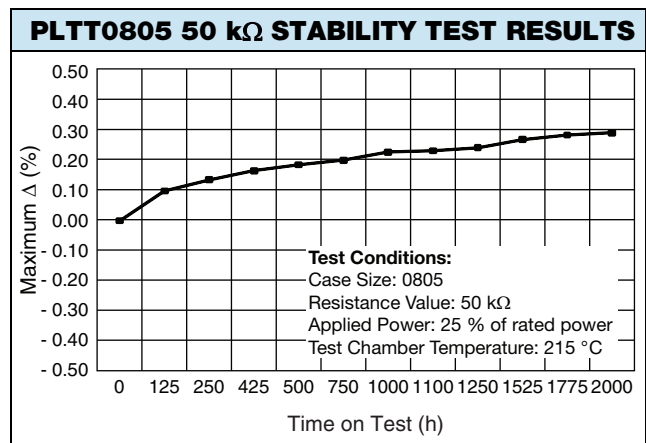
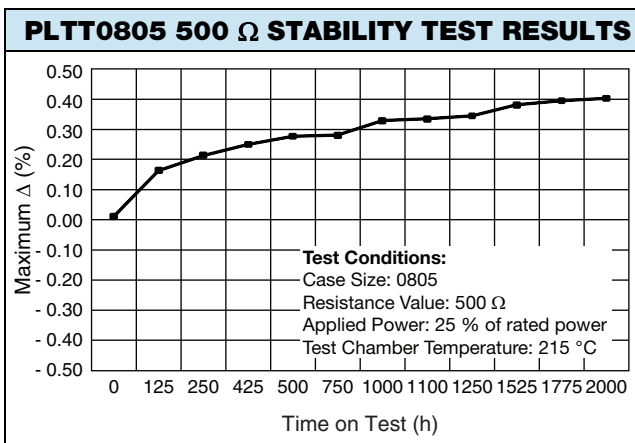
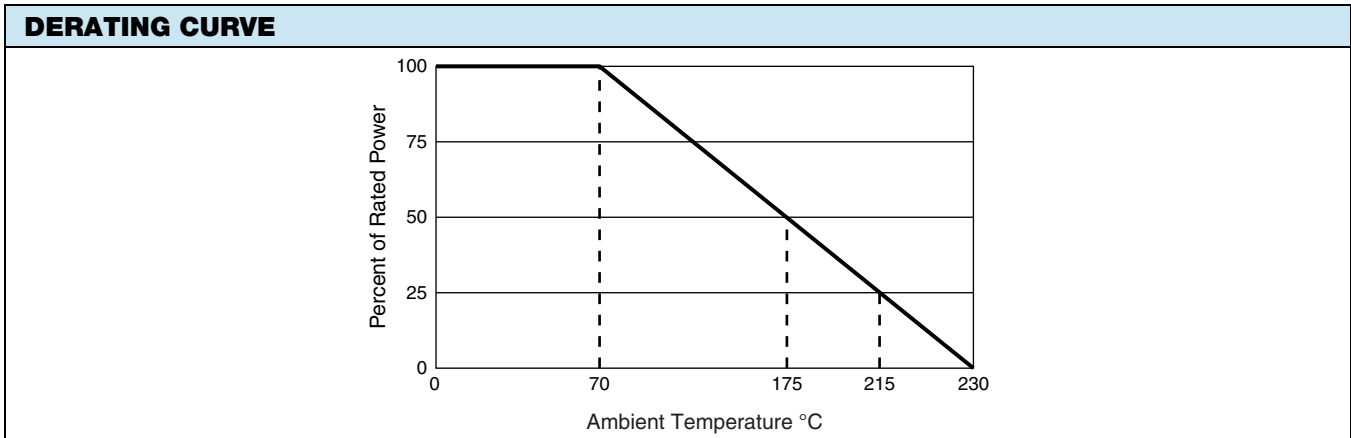

Note

- Performance obtained with following mounting conditions
 PCB: Polyimide IPC-7831A STD land patterns
 Solder paste: PbSnAg (93.5/5/1.5)

GLOBAL PART NUMBER INFORMATION

P	L	T	T	0	8	0	5	Z	1	0	0	1	Q	G	T	1
GLOBAL MODEL	CASE SIZE	TCR CHARACTERISTIC		RESISTANCE				TOLERANCE	TERMINATION			PACKAGING				
PLTT	0603 0805 1206 2010 2512	Z = ± 5 ppm/°C		The first 3 digits are significant figures and the last digit specifies the number of zeros to follow. "R" designates the decimal point. Example: 1001 = 1 kΩ 2500 = 250 Ω Special values with more than 4 significant figures, use a R for value below 1 kΩ and a K for values greater than 1 kΩ to signify a decimal point. 982R6 = 982.6 Ω 532R41 = 532.41 Ω				Q = ± 0.02 % ⁽¹⁾ A = ± 0.05 % B = ± 0.1 % D = ± 0.5 % F = ± 1 % G = ± 2 %	G = Wraparound Gold over Ni barrier (10 μ" min. Au)			WS = WAFFLE WI = 100 min./1mult (item single lot date code) WP = 100 min./1mult (package unit single lot date code) TAPE AND REEL T0 = 100 min., 100 mult T1 = 1000 min., 1000 mult T5 = 500 min., 500 mult TF = Full reel TS = 100 min., 1 mult TI = 100 min./1mult (item single lot date code) TP = 100 min., 1 mult (package unit single lot date code)				

Note

- ⁽¹⁾ Q tolerances are available only for resistance values ≥ 250 Ω.



Vishay Dale Thin Film Land Patterns

1. Scope

This technical note provides sample land patterns for Vishay Dale Thin Film SMT resistive products. The following drawings are based on IPC-SM-782 Surface Mount Design and Land Pattern Standard. These drawings are for reference only Vishay Thin Film recommends that the user contacts their PC board supplier for actual land patterns required. The pads are intended for lead (Pb)-free and tin / lead solder types.

2. Product Series

Thin Film Surface Mount Chip Resistors (FC, L, P, PTN, PLT, PLTT, PLTU, PAT, PATT, PNM, M/D55342 QPL Series)

0402 Land Pattern

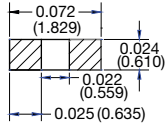

0502 Land Pattern

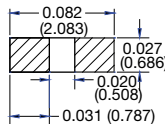

0505 Land Pattern

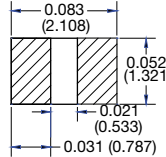

0603 Land Pattern

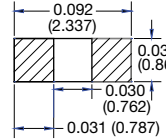

0705 Land Pattern

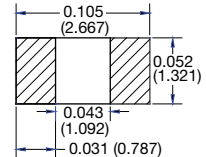

1005 Land Pattern

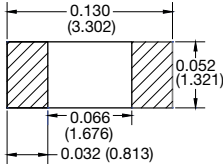

1010 Land Pattern

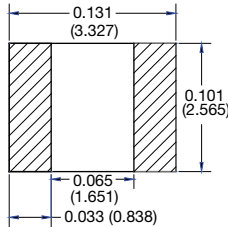

1206 Land Pattern

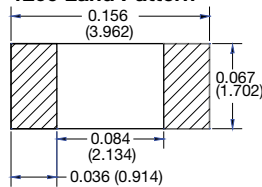

1505 Land Pattern

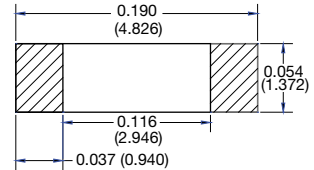

2010 Land Pattern

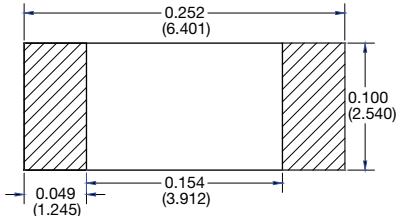

2208 Land Pattern

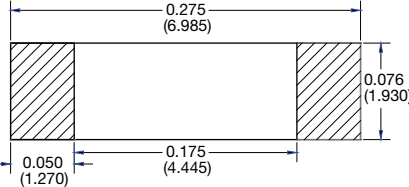

2512 Land Pattern

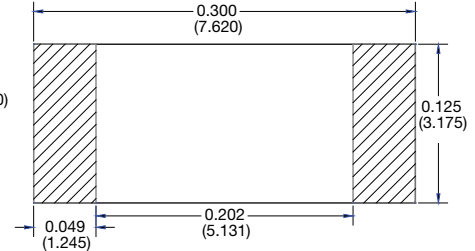



Thin Film Surface Mount Chip Resistors (PHP, PCAN Series)

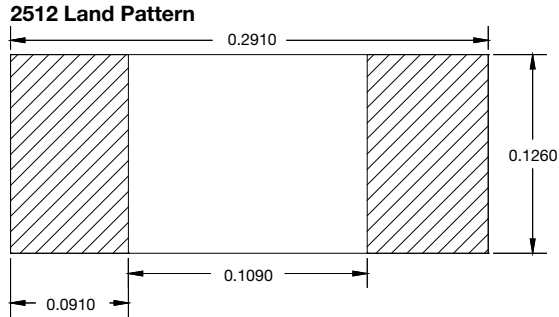
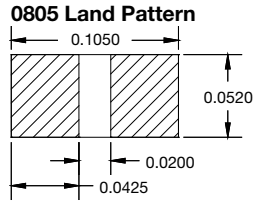
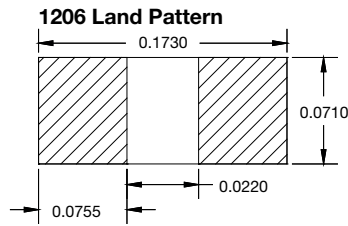
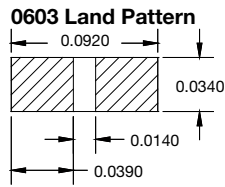

Thin Film Surface Mount Chip Resistors Long Axis Termination (L Series)

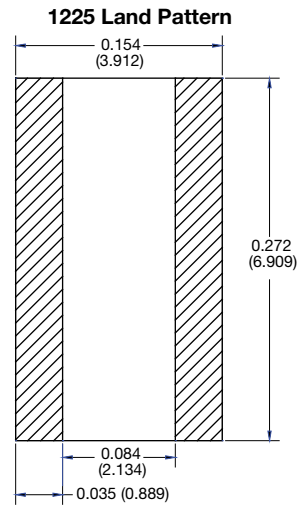
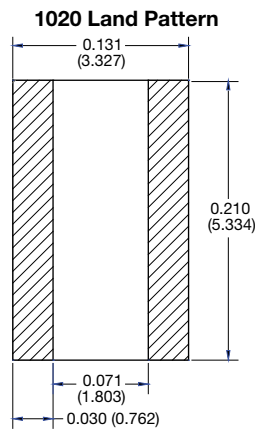
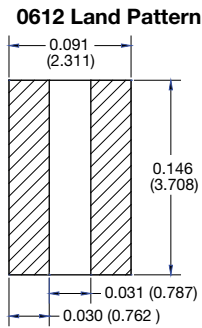
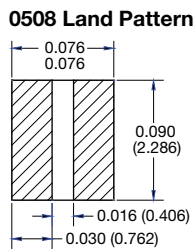



Surface Mount Networks (MPM, MP3, MP4 Series)

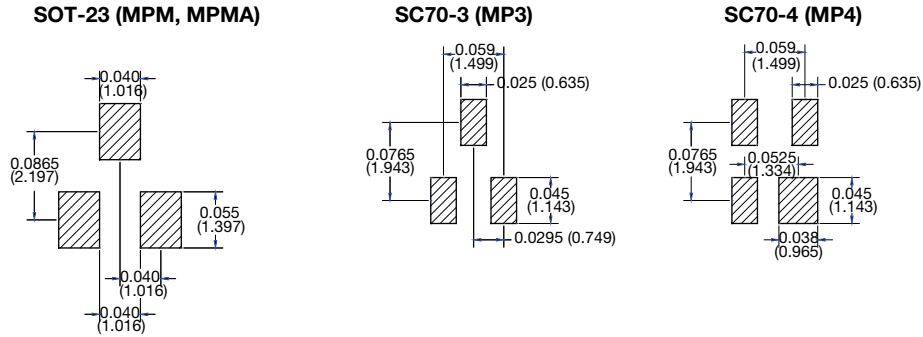

Surface Mount Networks SOIC Narrow Body 150 mils (ORN, CSO, MOMC, HTRN, AORN, MORN Series)

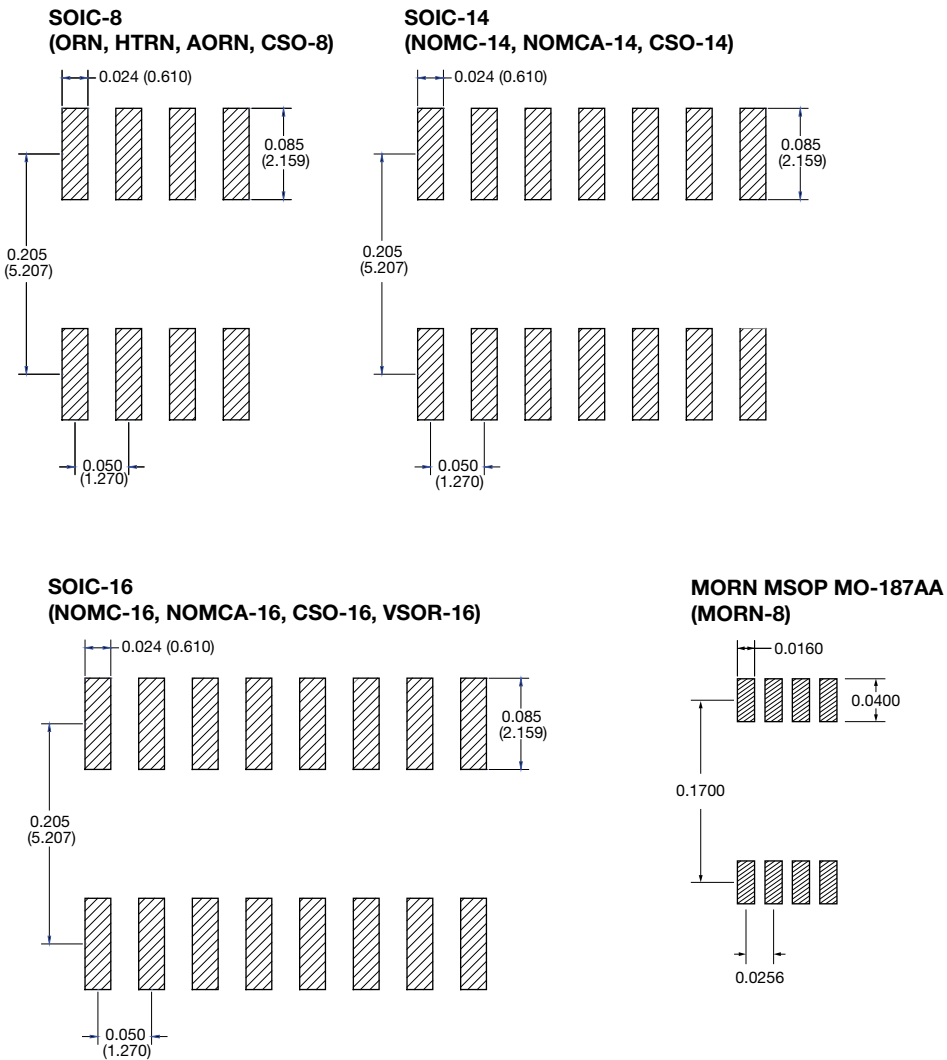



Surface Mount Networks SOIC Medium Body 220 mils (TOMC Series)

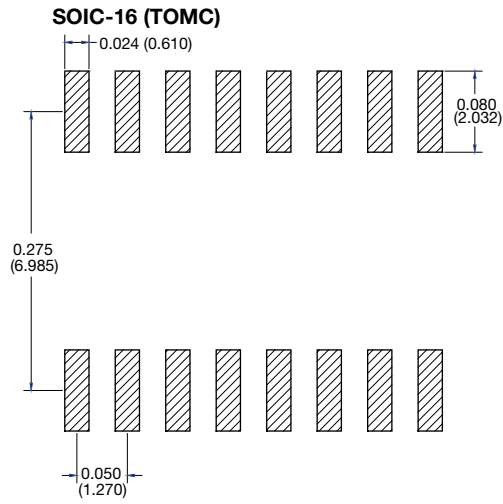

Surface Mount Networks SOIC Wide Body 300 mils (WOMC Series)

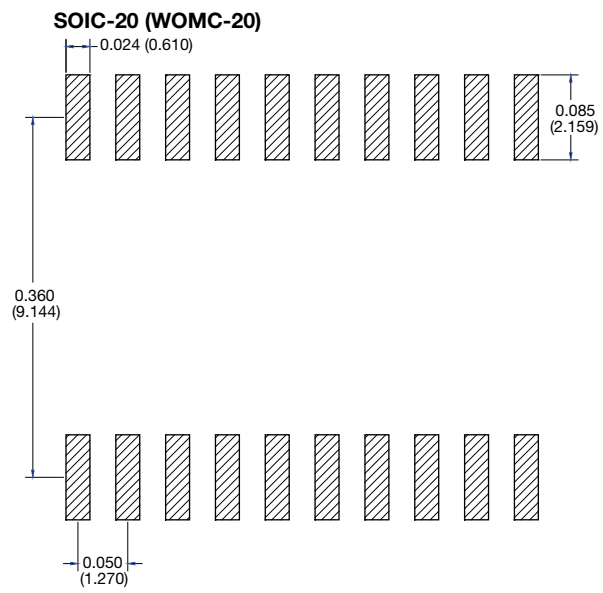
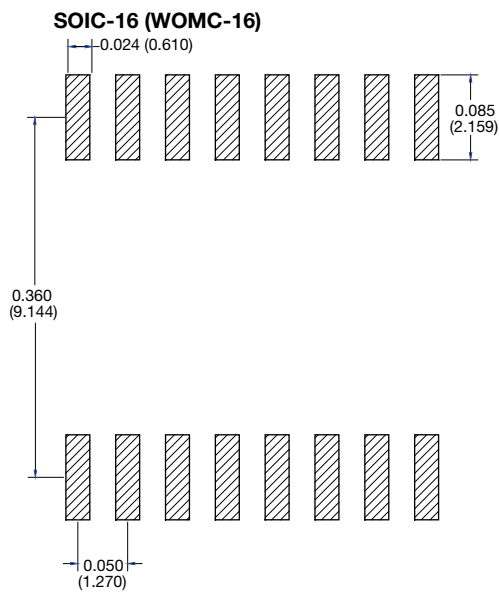



Surface Mount Networks High Density SSOP, TSOP (VSSR, VTSR Series)

SSOP MO-137

VSSR-16

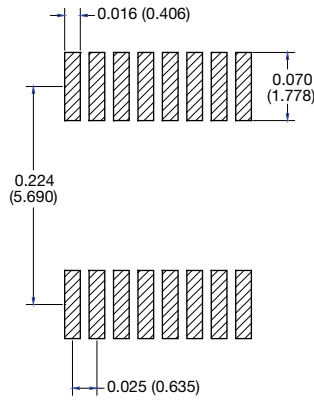

OSOP-16, OSOP-20, OSOP-24, VSSR-20

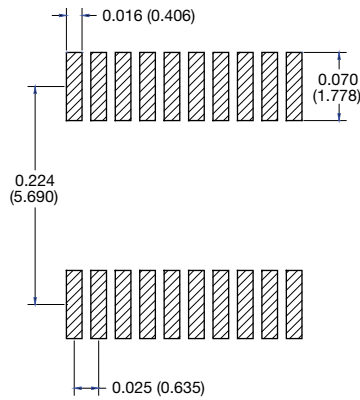

VSSR-24, HD-CSO-24

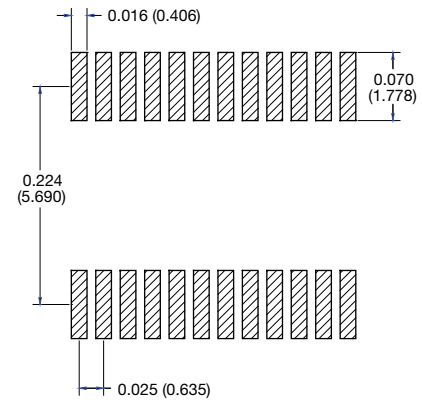

TSSOP MO-153

VTSR-16

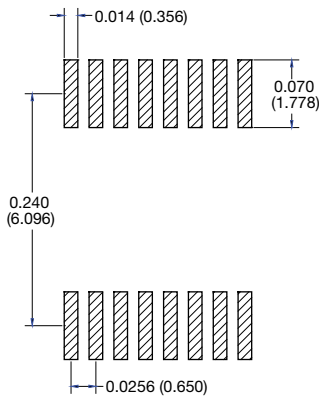

VTSR-20

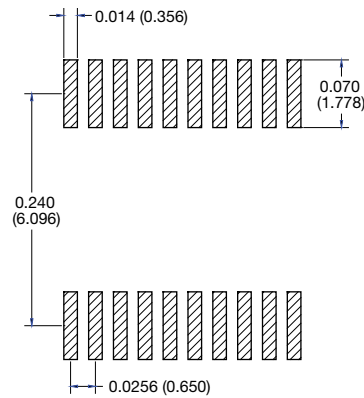

VTSR-24

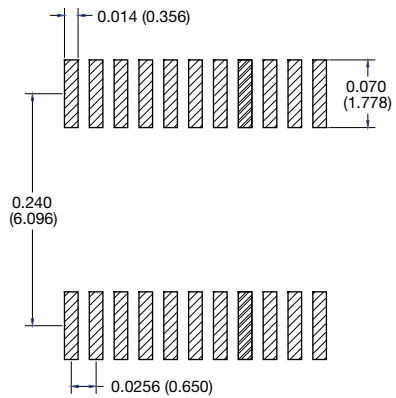

Surface Mount Leadless Networks (LCC Series)

16 Pin LCC

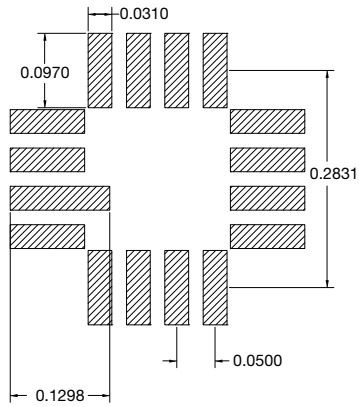

20 Pin LCC

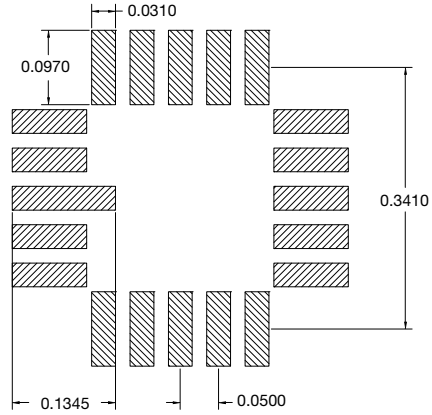

Surface Mount Leadless Networks (MPH Series)

4 Pin LCC

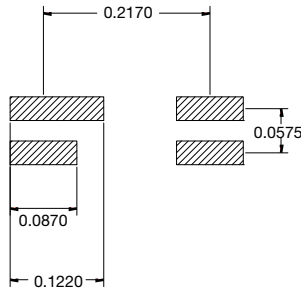

Surface Mount Leadless Packages DUAL/ QUAD Flat No Lead (DFN, QFN Series)

DFN MLP

DFN-8 4 x 5 mm Sq

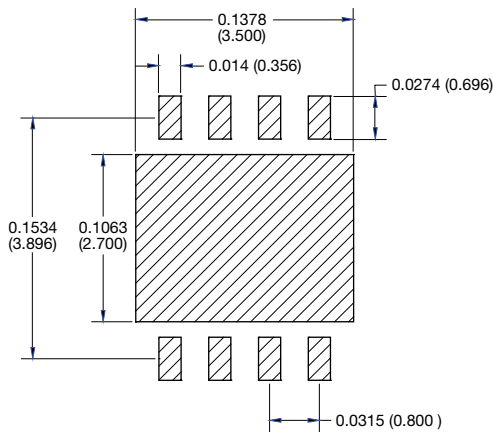

QFN MLP

QFN-20 5 x 5 mm Sq

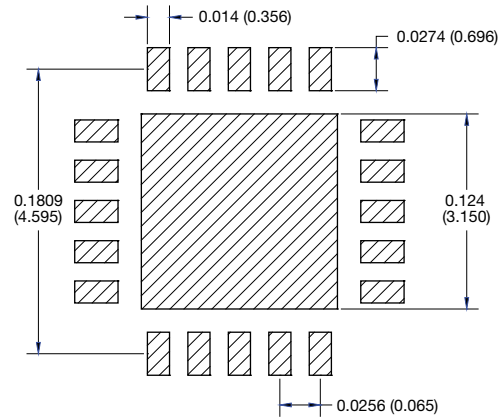



Surface Mount Leadless Resistor Arrays (PR Series)

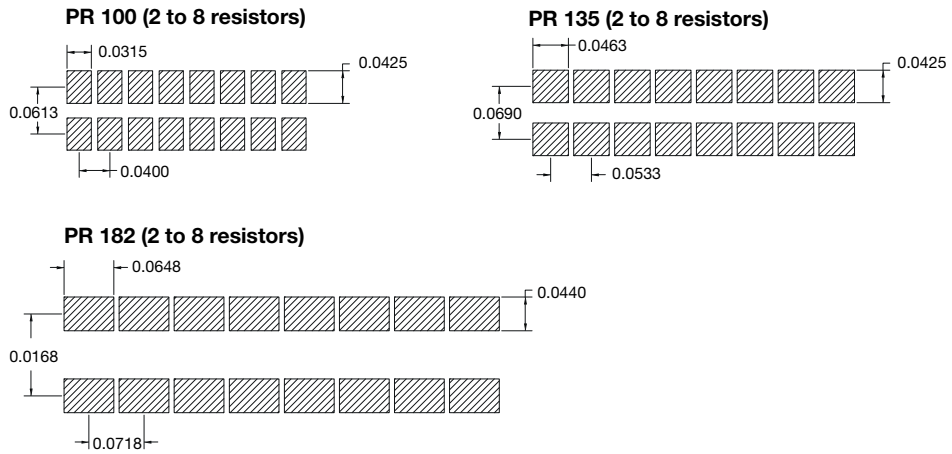

Note

- All dimensions in inches (mm)

Flatpack

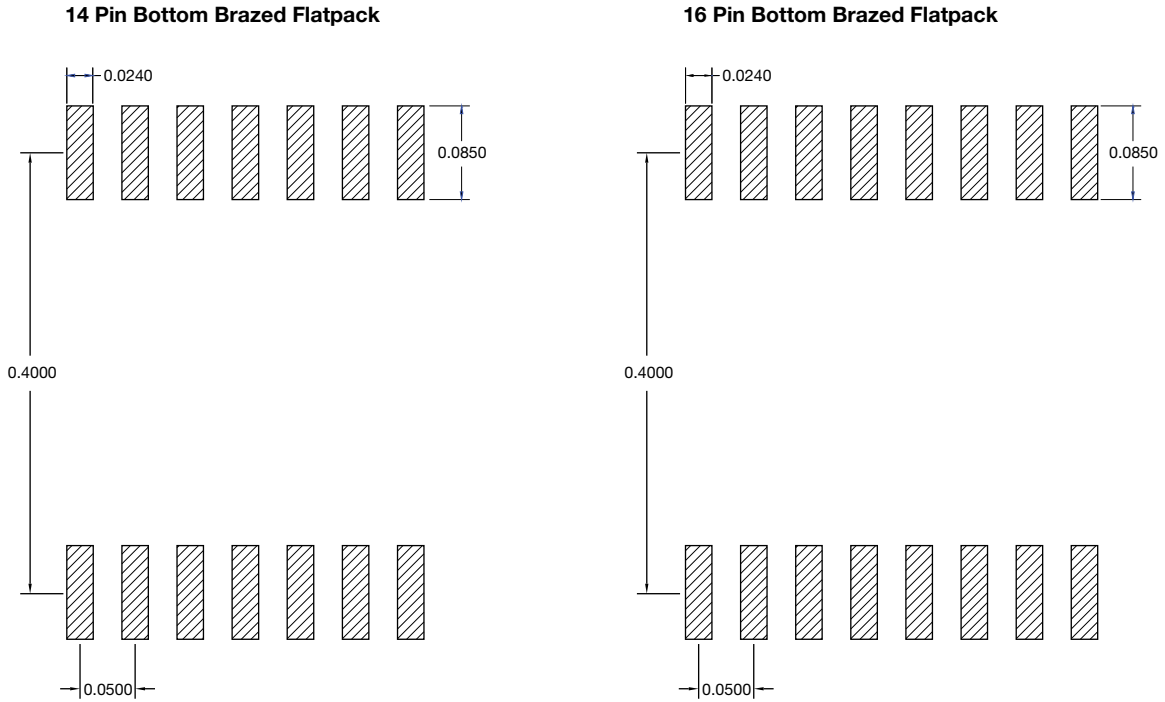



Disclaimer

ALL PRODUCT, PRODUCT SPECIFICATIONS AND DATA ARE SUBJECT TO CHANGE WITHOUT NOTICE TO IMPROVE RELIABILITY, FUNCTION OR DESIGN OR OTHERWISE.

Vishay Intertechnology, Inc., its affiliates, agents, and employees, and all persons acting on its or their behalf (collectively, "Vishay"), disclaim any and all liability for any errors, inaccuracies or incompleteness contained in any datasheet or in any other disclosure relating to any product.

Vishay makes no warranty, representation or guarantee regarding the suitability of the products for any particular purpose or the continuing production of any product. To the maximum extent permitted by applicable law, Vishay disclaims (i) any and all liability arising out of the application or use of any product, (ii) any and all liability, including without limitation special, consequential or incidental damages, and (iii) any and all implied warranties, including warranties of fitness for particular purpose, non-infringement and merchantability.

Statements regarding the suitability of products for certain types of applications are based on Vishay's knowledge of typical requirements that are often placed on Vishay products in generic applications. Such statements are not binding statements about the suitability of products for a particular application. It is the customer's responsibility to validate that a particular product with the properties described in the product specification is suitable for use in a particular application. Parameters provided in datasheets and / or specifications may vary in different applications and performance may vary over time. All operating parameters, including typical parameters, must be validated for each customer application by the customer's technical experts. Product specifications do not expand or otherwise modify Vishay's terms and conditions of purchase, including but not limited to the warranty expressed therein.

Except as expressly indicated in writing, Vishay products are not designed for use in medical, life-saving, or life-sustaining applications or for any other application in which the failure of the Vishay product could result in personal injury or death. Customers using or selling Vishay products not expressly indicated for use in such applications do so at their own risk. Please contact authorized Vishay personnel to obtain written terms and conditions regarding products designed for such applications.

No license, express or implied, by estoppel or otherwise, to any intellectual property rights is granted by this document or by any conduct of Vishay. Product names and markings noted herein may be trademarks of their respective owners.