

Certificate

Issue Date: August 2, 2017
Ref. Report No. ISL-17LE481CE

Product Name : 128GB pSLC SSD I-Temp
Model(s) : FA128GS3T-MAN3C
Responsible Party : IMSolution Co.,Ltd
Address : 1F.,No.8,Liujia 7th Rd.,Zhubei City, Hsinchu County 302,Taiwan(R.O.C.)

We, **International Standards Laboratory**, hereby certify that:

The device bearing the trade name and model specified above has been shown to comply with the applicable technical standards as indicated in the measurement report and was tested in accordance with the measurement procedures specified in European Council Directive- EMC Directive 2014/30/EU. The device was passed the test performed according to :



Standards:

EN 55032:2012+AC: 2013 and CISPR 32:2012
AS/NZS CISPR 32:2013
EN 61000-3-2:2014 and IEC 61000-3-2:2014
EN 61000-3-3: 2013 and IEC 61000-3-3: 2013
EN 55024: 2010+A1:2015 and CISPR 24: 2010+A1:2015
EN 61000-4-2: 2009 and IEC 61000-4-2: 2008
EN 61000-4-3: 2006+A1: 2008 +A2: 2010 and
IEC 61000-4-3:2006+A1: 2007+A2: 2010
EN 61000-4-8: 2010 and IEC 61000-4-8: 2009

I attest to the accuracy of data and all measurements reported herein were performed by me or were made under my supervision and are correct to the best of my knowledge and belief. I assume full responsibility for the completeness of these measurements and vouch for the qualifications of all persons taking them.

International Standards Laboratory

W.H. Chang / Director

Hsi-Chih LAB:

No. 65, Gu Dai Keng Street, Hsi-Chih Dist.,
New Taipei City 221, Taiwan
Tel: 886-2-2646-2550; Fax: 886-2-2646-4641



Lung-Tan LAB:

No. 120, Lane 180, Hsin Ho Rd., Lung-Tan Dist.,
Tao Yuan City 325, Taiwan
Tel: 886-3-407-1718; Fax: 886-3-407-1738



CE MARK TECHNICAL FILE

AS/NZS EMC CONSTRUCTION FILE

of

Product Name

128GB pSLC SSD I-Temp

Model

FA128GS3T-MAN3C

Contains:

1. Declaration of Conformity
2. EN55032/CISPR 32, AS/NZS CISPR 32 EMI test report
3. EN55024/CISPR 24, EN61000-3-2 / IEC 61000-3-2, and EN61000-3-3 / IEC 61000-3-3 test report
4. Block Diagram and Schematics
5. Users' manual

Declaration of Conformity

Name of Responsible Party: IMSolution Co.,Ltd
 Address of Responsible Party: 1F.,No.8,Liujia 7th Rd.,Zhubei City,
 Hsinchu County 302,Taiwan(R.O.C.)
 Declares that product: 128GB pSLC SSD I-Temp
 Model: FA128GS3T-MAN3C
 Assembled by: Same as above
 Address: Same as above

Conforms to the EMC Directive 2014/30/EU as attested by conformity with the following harmonized standards:

EN 55032:2012+AC: 2013, CISPR 32:2012: Electromagnetic compatibility of multimedia equipment - Emission requirements.
 AS/NZS CISPR 32:2013: Electromagnetic compatibility of multimedia equipment- Emission requirements

Performed Item	Test Performed	Deviation	Result
Conducted emissions from the AC mains power ports	Yes	No	PASS
Telecommunication Port Conducted Emissions (asymmetric mode)	Yes	No	PASS
Radiated emissions at frequencies below 1 GHz	Yes	No	PASS
Radiated emissions at frequencies above 1 GHz	Yes	No	PASS
Radiated emissions from FM receivers	N/A	N/A	N/A
Voltage Disturbance Emissions at Antenna Terminals	N/A	N/A	N/A
Differential voltage emissions	N/A	N/A	N/A

EN 55024:2010+A1:2015 and CISPR 24:2010+A1:2015: Information technology equipment-Immunity characteristics - Limits and methods of measurement.

Standard	Description	Results	Criteria
EN 61000-4-2:2009 IEC 61000-4-2:2008	Electrostatic Discharge	Pass	B
EN 61000-4-3:2006+A1:2008 +A2:2010 IEC 61000-4-3:2006+A1:2007+A2:2010	Radio-Frequency, Electromagnetic Field	Pass	A
EN 61000-4-8:2010 IEC 61000-4-8:2009	Power Frequency Magnetic Field	Pass	A

<to be continued>

Standard	Description	Results
EN 61000-3-2:2014 IEC 61000-3-2:2014	Limits for harmonics current emissions	Pass
EN 61000-3-3:2013 IEC 61000-3-3:2013	Limits for voltage fluctuations and flicker in low-voltage supply systems.	Pass

We, IMSolution Co.,Ltd, hereby declare that the equipment bearing the trade name and model number specified above was tested conforming to the applicable Rules under the most accurate measurement standards possible, and that all the necessary steps have been taken and are in force to assure that production units of the same equipment will continue to comply with the requirements.

IMSolution Co.,Ltd

Date: August 2, 2017

Declaration of Conformity

Name of Responsible Party: IMSolution Co.,Ltd
Address of Responsible Party: 1F.,No.8,Liujia 7th Rd.,Zhubei City,
Hsinchu County 302,Taiwan(R.O.C.)
Declares that product: 128GB pSLC SSD I-Temp
Model: FA128GS3T-MAN3C
Assembled by: Same as above
Address: Same as above

Conforms to the EMI part of RCM Mark requirements as attested by conformity with the following standards:

AS/NZS CISPR 32:2013: Electromagnetic compatibility of multimedia equipment-
Emission requirements

We, IMSolution Co.,Ltd, hereby declare that the equipment bearing the trade name and model number specified above was tested conforming to the applicable Rules under the most accurate measurement standards possible, and that all the necessary steps have been taken and are in force to assure that production units of the same equipment will continue to comply with the requirements.

IMSolution Co.,Ltd

Date: August 2, 2017

CE TEST REPORT

of
EN55032 / CISPR 32 / AS/NZS CISPR 32
Class B
EN55024 / CISPR 24 / IMMUNITY
EN61000-3-2 / EN61000-3-3

Product : **128GB pSLC SSD I-Temp**

Model(s): **FA128GS3T-MAN3C**

Applicant: **IMSolution Co.,Ltd**

Address: **1F.,No.8,Liujia 7th Rd.,Zhubei City,
Hsinchu County 302,Taiwan(R.O.C.)**

Test Performed by:

International Standards Laboratory

<Lung-Tan LAB>

*Site Registration No.

BSMI: SL2-IN-E-0013; SL2-R1/R2-E-0013; TAF: 0997

FCC: TW1036; IC: IC4067B-1; NEMKO: ELA 113B

VCCI: <Conduction 02>C-1440, T-1676, <Conduction 03>C-2845,

T-1464, <Conduction 04>C-4778, T-2295, <Chamber 02>R-1435, G-17,

<Chamber 12>R-2598, G-16, <Chamber 14>G-211,

*Address:

No. 120, Lane 180, Hsin Ho Rd.,

Lung-Tan Dist., Tao Yuan City 325, Taiwan

*Tel: 886-3-407-1718; Fax: 886-3-407-1738

Report No.: **ISL-17LE481CE**

Issue Date : **August 2, 2017**

This report totally contains 50 pages including this cover page and contents page.

Test results given in this report apply only to the specific sample(s) tested and are traceable to national or international standard through calibration of the equipment and evaluating measurement uncertainty herein.

This test report shall not be reproduced except in full, without the written approval of International Standards Laboratory.

Contents of Report

1.	General.....	1
1.1	Certification of Accuracy of Test Data.....	1
1.2	Test Standards.....	2
1.3	Description of EUT	4
1.4	Description of Support Equipment	5
1.5	Software for Controlling Support Unit.....	6
1.6	I/O Cable Condition of EUT and Support Units	7
2.	Power Main Port Conducted Emissions.....	8
2.1	Test Setup and Procedure	8
2.2	Conduction Test Data: Configuration 1.....	10
2.3	Conduction Test Data: Configuration 2.....	12
2.4	Test Setup Photo	14
3.	Telecommunication Port Conducted Emissions.....	16
3.1	Test Setup and Procedure	16
4.	Radiated Disturbance Emissions.....	18
4.1	Test Setup and Procedure	18
4.2	Limit	20
4.3	Radiation Test Data: Configuration 1.....	22
4.4	Radiation Test Data: Configuration 2.....	26
4.5	Test Setup Photo	30
5.	Electrostatic discharge (ESD) immunity.....	32
5.1	Test Specification and Setup	32
5.2	Test Point.....	33
5.3	Test Setup Photo	34
6.	Radio-Frequency, Electromagnetic Field immunity	35
6.1	Test Specification and Setup	35
6.2	Test Setup Photo.....	36
7.	Power Frequency Magnetic Field immunity.....	37
7.1	Test Specification and Setup	37
7.2	Test Setup Photo.....	38
8.	Harmonics	39
8.1	Test Specification and Setup	39
9.	Voltage Fluctuations	41
9.1	Test Specification and Setup	41
9.2	Test Data.....	42
9.3	Test Setup Photo.....	43
10.	Appendix.....	44
10.1	Appendix A: Test Equipment.....	44
10.2	Appendix B: Uncertainty of Measurement.....	47
10.3	Appendix C: Photographs of EUT Please refer to the File of ISL-17LE335P.....	48

1. General

1.1 Certification of Accuracy of Test Data

Standards: Please refer to 1.2

Equipment Tested: 128GB pSLC SSD I-Temp

Model: FA128GS3T-MAN3C

Applicant: IMSolution Co.,Ltd

Sample received Date: July 29, 2017

Final test Date: EMI:refer to the date of test data
EMS: August 1, 2017

Test Site: International Standards Laboratory
Chamber 12; Chamber 14; Conduction 02; Immunity02

Test Distance: 10M; 3M (above1GHz) (EMI test)

Temperature: refer to each site test data

Humidity: refer to each site test data

Atmospheric Pressure: 86 kPa to 106 kPa

Input power: Conduction input power: AC 230 V / 50 Hz ; AC110 V / 60 Hz
Radiation input power: AC 230 V / 50 Hz ; AC110 V / 60 Hz
Immunity input power: AC 230 V / 50 Hz

Test Result: **PASS**

Report Engineer: Jayla Lu

Test Engineer: Kevin Chan
Kevin Chan

Approved By: W.H. Chang
W.H. Chang / Director

1.2 Test Standards

The tests which this report describes were conducted by an independent electromagnetic compatibility consultant, International Standards Laboratory in accordance with the following

EN 55032:2012+AC: 2013, CISPR 32:2012: Class B: Electromagnetic compatibility of multimedia equipment - Emission requirements.

AS/NZS CISPR 32:2013: Class B: Electromagnetic compatibility of multimedia equipment- Emission requirements

Performed Item	Test Performed	Deviation	Result
Conducted emissions from the AC mains power ports	Yes	No	PASS
Telecommunication Port Conducted Emissions (asymmetric mode)	Yes	No	PASS
Radiated emissions at frequencies below 1 GHz	Yes	No	PASS
Radiated emissions at frequencies above 1 GHz	Yes	No	PASS
Radiated emissions from FM receivers	N/A	N/A	N/A
Voltage Disturbance Emissions at Antenna Terminals	N/A	N/A	N/A
Differential voltage emissions	N/A	N/A	N/A

EN 55024:2010+A1:2015 and CISPR 24:2010+A1:2015: Information technology equipment-Immunity characteristics - Limits and methods of measurement.

Standard	Description	Results	Criteria
EN 61000-4-2:2009 IEC 61000-4-2:2008	Electrostatic Discharge	Pass	B
EN 61000-4-3:2006+A1:2008 +A2:2010 IEC 61000-4-3:2006+A1:2007+A2:2010	Radio-Frequency, Electromagnetic Field	Pass	A
EN 61000-4-8:2010 IEC 61000-4-8:2009	Power Frequency Magnetic Field	Pass	A

Standard	Description	Results
EN 61000-3-2:2014 IEC 61000-3-2:2014	Limits for harmonics current emissions	Pass
EN 61000-3-3:2013 IEC 61000-3-3:2013	Limits for voltage fluctuations and flicker in low-voltage supply systems.	Pass

1.2.1 Performance Criteria for Compliance: EN 55024

Performance criterion A

During and after the test the EUT shall continue to operate as intended without operator intervention. No degradation of performance or loss of function is allowed below a minimum performance level specified by the manufacturer when the EUT is used as intended. The performance level may be replaced by a permissible loss of performance. If the minimum performance level or the permissible performance loss is not specified by the manufacturer, then either of these may be derived from the product description and documentation, and by what the user may reasonably expect from the EUT if used as intended.

Performance criterion B

After the test, the EUT shall continue to operate as intended without operator intervention. No degradation of performance or loss of function is allowed, after the application of the phenomena below a performance level specified by the manufacturer, when the EUT is used as intended. The performance level may be replaced by a permissible loss of performance. During the test, degradation of performance is allowed. However, no change of operating state or stored data is allowed to persist after the test. If the minimum performance level (or the permissible performance loss) is not specified by the manufacturer, then either of these may be derived from the product description and documentation, and by what the user may reasonably expect from the EUT if used as intended.

Performance criterion C

During and after testing, a temporary loss of function is allowed, provided the function is self-recoverable, or can be restored by the operation of the controls or cycling of the power to the EUT by the user in accordance with the manufacturer's instructions.

Functions, and/or information stored in non-volatile memory, or protected by a battery backup, shall not be lost.

1.3 Description of EUT

EUT

Description	128GB pSLC SSD I-Temp
Condition	Pre-Production
Model	FA128GS3T-MAN3C
Serial Number	N/A
Power:	From Personal Computer Supply
Control IC	SSD controller
Highest working frequency	104MHz

The memory capacity listed below is chosen by the applicant to be the representative configuration for testing in this report.

Test configurations:

EMI

Configuration	Memory Capacity	Control IC	Support PC voltage
1	128GB	SSD controller	230V
2	128GB	SSD controller	110V

EMS

Configuration	Memory Capacity	Control IC	Support PC voltage
1	128GB	SSD controller	230V

EMI Noise Source:

Control IC	Crystal
SSD controller	104MHz

EMI Solution:

N/A

1.4 Description of Support Equipment

For EMI test configuration Support unit: 1~6

For EMS test configuration Support unit: 2~7

No	Unit	Model / Serial No.	Brand	Power Cord	FCC ID
1	27" LCD Monitor	B273HU S/N: N/A	acer	Non-shielded	FCC DOC
2	PS2 Keyboard	Y-S0002 S/N: N/A	Logitech	N/A	FCC DOC
3	PS2 Mouse	M-SBM96B S/N: N/A	Logitech	N/A	FCC DOC
4	Printer	C930 S/N: N/A	HP	Non-shielded	FCC DOC
5	Modem	DM1414 S/N: N/A	Aceex	Non-shielded	FCC DOC
6	Personal Computer	Compaq 8300 S/N: N/A	HP	Non-shielded	FCC DOC
7	24" LCD Monitor	U2410F S/N: N/A	DELL	Non-shielded	FCC DOC

1.5 Software for Controlling Support Unit

Test programs exercising various part of EUT were used. The programs were executed as follows:

For EMI

1. PC running Winthrax to read and write the EUT through PC SSD Port.
2. Send signal to the Printer through PC Parallel Port.
3. Send signal to the Modem through PC Serial Port.
4. Send Color Bar to the LCD Monitor through PC D-SUB Port.
5. Repeat the above steps.

	Filename	Issued Date
EUT	Winthrax	06/14/2005
Printer	IntelEMC	04/11/2007
Modem	IntelEMC	04/11/2007
Monitor	Color Bar	01/05/2017

For EMS

1. PC running Winthrax to read and write the EUT .
2. Send signal to the Printer through PC USB Port.
3. Read and write External Hard Disk through PC USB 2.0 Port.
4. Send H pattern to the LCD Monitor through PC D-SUB Port.
5. Repeat the above steps.

	Filename	Issued Date
EUT	Winthrax	06/14/2005
Printer	IntelEMC	04/11/2007
Modem	IntelEMC	04/11/2007
Monitor	IntelEMC	01/05/2017

1.6 I/O Cable Condition of EUT and Support Units

Description	Path	Cable Length	Cable Type
AC Power Cable	110V (~240V) to PC SPS	1.8m	Non-shielded
PS2 Keyboard Data Cable	PS2 Keyboard to PC PS2 Port	1.8m	Shielded
PS2 Mouse Data Cable	PS2 Mouse to PC PS2 Port	1.8m	Shielded
Monitor Data Cable	LCD Monitor D-SUB Port to PC D-SUB Port	1.8m	Shielded (with core)
Printer Data Cable	Printer Port to PC Parallel Port	1.8m	Shielded
Modem Data Cable	Modem to PC Serial Port	1.8m	Shielded

2.1.4 Limit

Conducted emissions from the AC mains power ports of Class A equipment:

Frequency	QP	AV
MHz	dBuV/m	dBuV/m
0.15-0.50	79	73
5.0-30	66	60
Note: The lower limit shall apply at the transition frequencies		

Conducted emissions from the AC mains power ports of Class B equipment:

Frequency	QP	AV
MHz	dBuV/m	dBuV/m
0.15-0.50	66-56	56-46
0.50-5.0	56	46
5.0-30	60	50
Note: The lower limit shall apply at the transition frequencies		

2.2 Conduction Test Data: Configuration 1

Table 2.2.1 Power Line Conducted Emissions (Live)

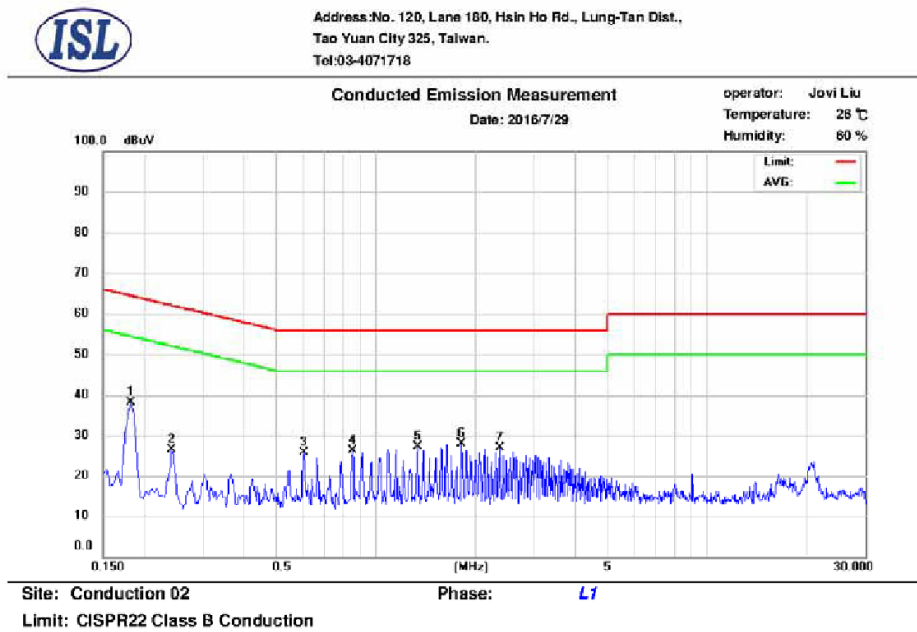

No.	Frequency (MHz)	QP_R (dBuV)	AVG_R (dBuV)	Correct Factor (dB)	QP Emission (dBuV)	QP Limit (dBuV)	QP Margin (dB)	AVG Emission (dBuV)	AVG Limit (dBuV)	AVG Margin (dB)
1	0.182	27.60	25.47	9.65	37.25	64.39	-27.14	35.12	54.39	-19.27
2	0.242	14.86	13.95	9.65	24.51	62.03	-37.52	23.60	52.03	-28.43
3	0.606	13.73	13.10	9.67	23.40	56.00	-32.60	22.77	46.00	-23.23
4	0.850	14.86	13.11	9.67	24.53	56.00	-31.47	22.78	46.00	-23.22
5	1.334	15.52	14.15	9.69	25.21	56.00	-30.79	23.84	46.00	-22.16
6	1.818	11.50	5.71	9.71	21.21	56.00	-34.79	15.42	46.00	-30.58
7	2.362	13.10	9.40	9.72	22.82	56.00	-33.18	19.12	46.00	-26.88

Note:

Margin = QP/AVG Emission - Limit

QP/AVG Emission = QP_R/AVG_R + Correct Factor

Correct Factor = LISN Loss + Cable Loss

A margin of -8dB means that the emission is 8dB below the limit

The frequency spectrum graph is for final peak graph, and the attached table is for QP/AVG test result.

If peak data can pass, it will be shown in “QP/AVG Correct” column, if not, QP/AVG data will instead.

Table 2.2.2 Power Line Conducted Emissions (Neutral)

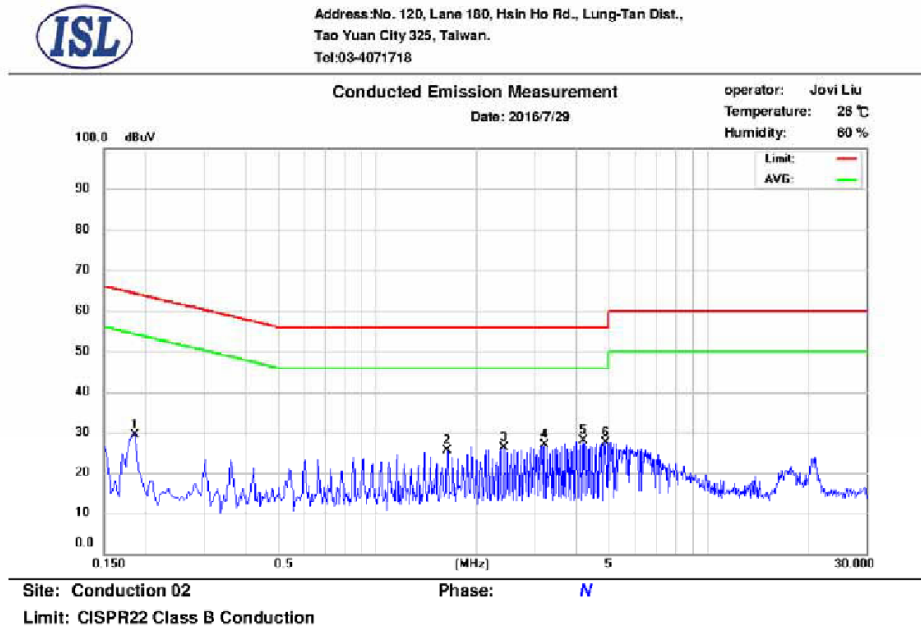

No.	Frequency (MHz)	QP_R (dBuV)	AVG_R (dBuV)	Correct Factor (dB)	QP Emission (dBuV)	QP Limit (dBuV)	QP Margin (dB)	AVG Emission (dBuV)	AVG Limit (dBuV)	AVG Margin (dB)
1	0.186	16.29	10.64	9.63	25.92	64.21	-38.29	20.27	54.21	-33.94
2	1.634	13.68	12.29	9.69	23.37	56.00	-32.63	21.98	46.00	-24.02
3	2.422	14.65	12.37	9.71	24.36	56.00	-31.64	22.08	46.00	-23.92
4	3.210	15.10	12.65	9.73	24.83	56.00	-31.17	22.38	46.00	-23.62
5	4.182	14.40	7.32	9.75	24.15	56.00	-31.85	17.07	46.00	-28.93
6	4.902	15.68	11.85	9.77	25.45	56.00	-30.55	21.62	46.00	-24.38

Note:

Margin = QP/AVG Emission - Limit

QP/AVG Emission = QP_R/AVG_R + Correct Factor

Correct Factor = LISN Loss + Cable Loss

A margin of -8dB means that the emission is 8dB below the limit

The frequency spectrum graph is for final peak graph, and the attached table is for QP/AVG test result.

If peak data can pass, it will be shown in "QP/AVG Correct" column, if not, QP/AVG data will instead.

2.3 Conduction Test Data: Configuration 2

Table 2.3.1 Power Line Conducted Emissions (Live)

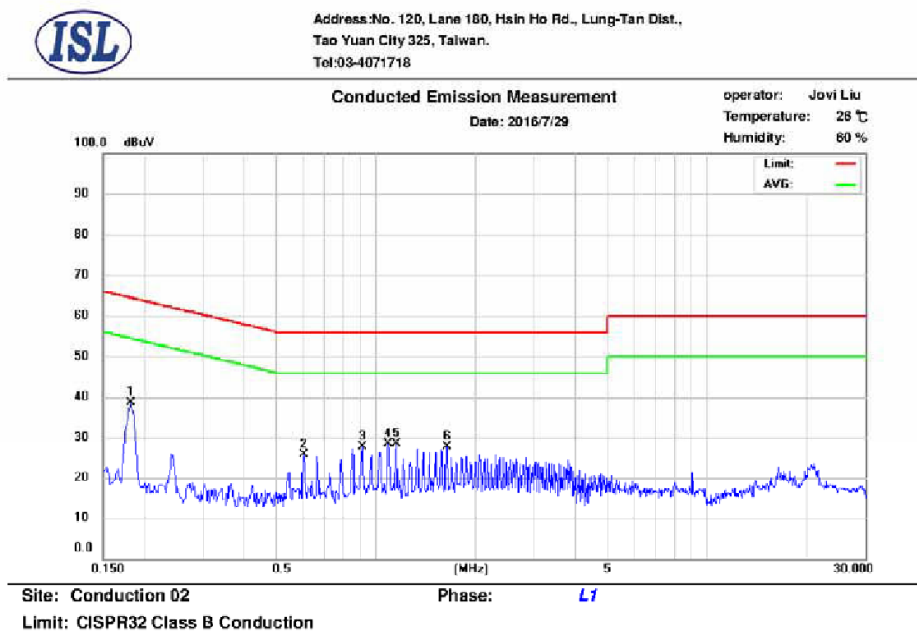

No.	Frequency (MHz)	QP_R (dBuV)	AVG_R (dBuV)	Correct Factor (dB)	QP Emission (dBuV)	QP Limit (dBuV)	QP Margin (dB)	AVG Emission (dBuV)	AVG Limit (dBuV)	AVG Margin (dB)
1	0.182	26.55	23.65	9.65	36.20	64.39	-28.19	33.30	54.39	-21.09
2	0.606	13.65	12.33	9.67	23.32	56.00	-32.68	22.00	46.00	-24.00
3	0.910	15.99	10.67	9.68	25.67	56.00	-30.33	20.35	46.00	-25.65
4	1.090	16.37	13.65	9.68	26.05	56.00	-29.95	23.33	46.00	-22.67
5	1.150	14.67	12.36	9.68	24.35	56.00	-31.65	22.04	46.00	-23.96
6	1.638	15.66	13.26	9.70	25.36	56.00	-30.64	22.96	46.00	-23.04

Note:

Margin = QP/AVG Emission - Limit

QP/AVG Emission = QP_R/AVG_R + Correct Factor

Correct Factor = LISN Loss + Cable Loss

A margin of -8dB means that the emission is 8dB below the limit

The frequency spectrum graph is for final peak graph, and the attached table is for QP/AVG test result.

If peak data can pass, it will be shown in “QP/AVG Correct” column, if not, QP/AVG data will instead.

Table 2.3.2 Power Line Conducted Emissions (Neutral)

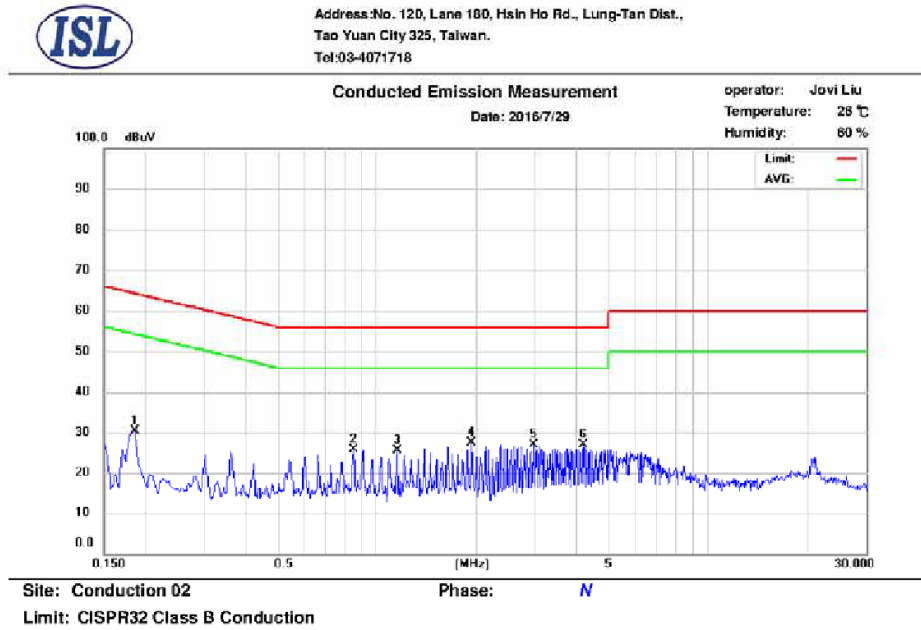

No.	Frequency (MHz)	QP_R (dBuV)	AVG_R (dBuV)	Correct Factor (dB)	QP Emission (dBuV)	QP Limit (dBuV)	QP Margin (dB)	AVG Emission (dBuV)	AVG Limit (dBuV)	AVG Margin (dB)
1	0.186	19.66	15.67	9.63	29.29	64.21	-34.92	25.30	54.21	-28.91
2	0.850	13.66	12.67	9.66	23.32	56.00	-32.68	22.33	46.00	-23.67
3	1.150	14.34	12.74	9.67	24.01	56.00	-31.99	22.41	46.00	-23.59
4	1.938	15.34	13.67	9.70	25.04	56.00	-30.96	23.37	46.00	-22.63
5	2.966	14.37	12.67	9.72	24.09	56.00	-31.91	22.39	46.00	-23.61
6	4.182	15.33	12.36	9.75	25.08	56.00	-30.92	22.11	46.00	-23.89

Note:

Margin = QP/AVG Emission - Limit

QP/AVG Emission = QP_R/AVG_R + Correct Factor

Correct Factor = LISN Loss + Cable Loss

A margin of -8dB means that the emission is 8dB below the limit

The frequency spectrum graph is for final peak graph, and the attached table is for QP/AVG test result.

If peak data can pass, it will be shown in "QP/AVG Correct" column, if not, QP/AVG data will instead.

2.4 Test Setup Photo

Front View



Back View



3.1.4 Limit

Asymmetric mode conducted emissions from Class A equipment:

Applicable to

1. wired network ports.
2. optical fibre ports with metallic shield or tension members.
3. antenna ports.

Frequency range MHz	Coupling device (see Table A.7)	Detector type / bandwidth	Class A voltage limits dB(μ V)	Class A current limits dB(μ A)
0,15 – 0,5	AAN	Quasi Peak / 9 kHz	97 – 87	n/a
0,5 – 30			87	
0,15 – 0,5	AAN	Average / 9 kHz	84 – 74	
0,5 – 30			74	
0,15 – 0,5	CVP and current probe	Quasi Peak / 9 kHz	97 – 87	53 – 43
0,5 – 30			87	43
0,15 – 0,5	CVP and current probe	Average / 9 kHz	84 – 74	40 – 30
0,5 – 30			74	30
0,15 – 0,5	Current Probe	Quasi Peak / 9 kHz	n/a	53 – 43
0,5 – 30				43
0,15 – 0,5	Current Probe	Average / 9 kHz		40 – 30
0,5 – 30				30

Asymmetric mode conducted emissions from Class B equipment:

Applicable to:

1. wired network ports.
2. optical fibre ports with metallic shield or tension members.
3. broadcast receiver tuner ports.
4. antenna ports.

Frequency range MHz	Coupling device (see Table A.7)	Detector type / bandwidth	Class B voltage limits dB(μ V)	Class B current limits dB(μ A)
0,15 – 0,5	AAN	Quasi Peak / 9 kHz	84 – 74	n/a
0,5 – 30			74	
0,15 – 0,5	AAN	Average / 9 kHz	74 – 64	
0,5 – 30			64	
0,15 – 0,5	CVP and current probe	Quasi Peak / 9 kHz	84 – 74	40 – 30
0,5 – 30			74	30
0,15 – 0,5	CVP and current probe	Average / 9 kHz	74 – 64	30 – 20
0,5 – 30			64	20
0,15 – 0,5	Current Probe	Quasi Peak / 9 kHz	n/a	40 – 30
0,5 – 30				30
0,15 – 0,5	Current Probe	Average / 9 kHz		30 – 20
0,5 – 30				20

4. Radiated Disturbance Emissions

4.1 Test Setup and Procedure

4.1.1 Test Setup

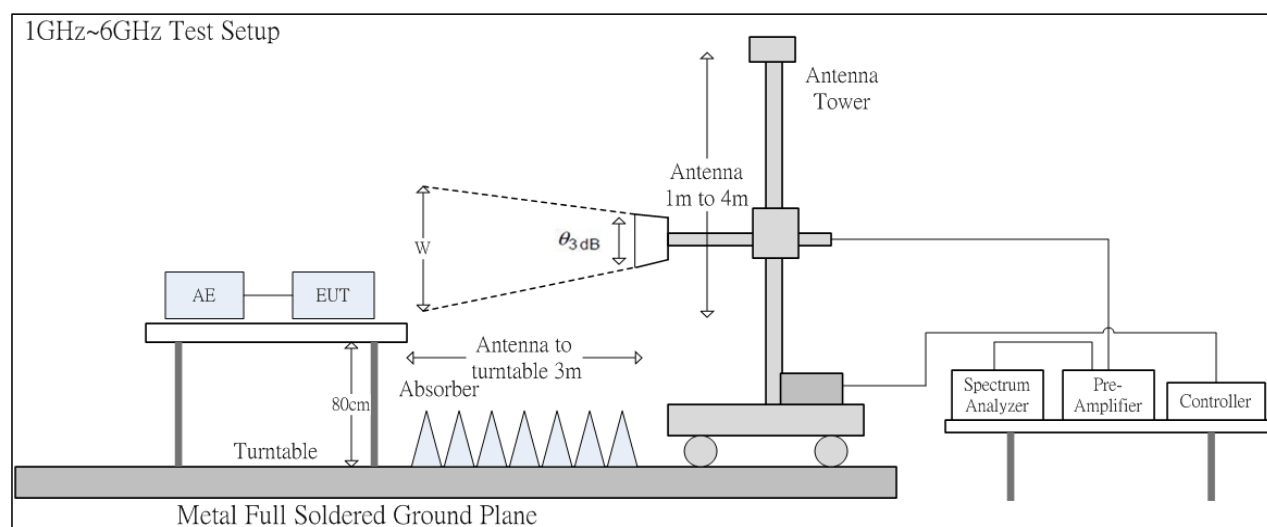
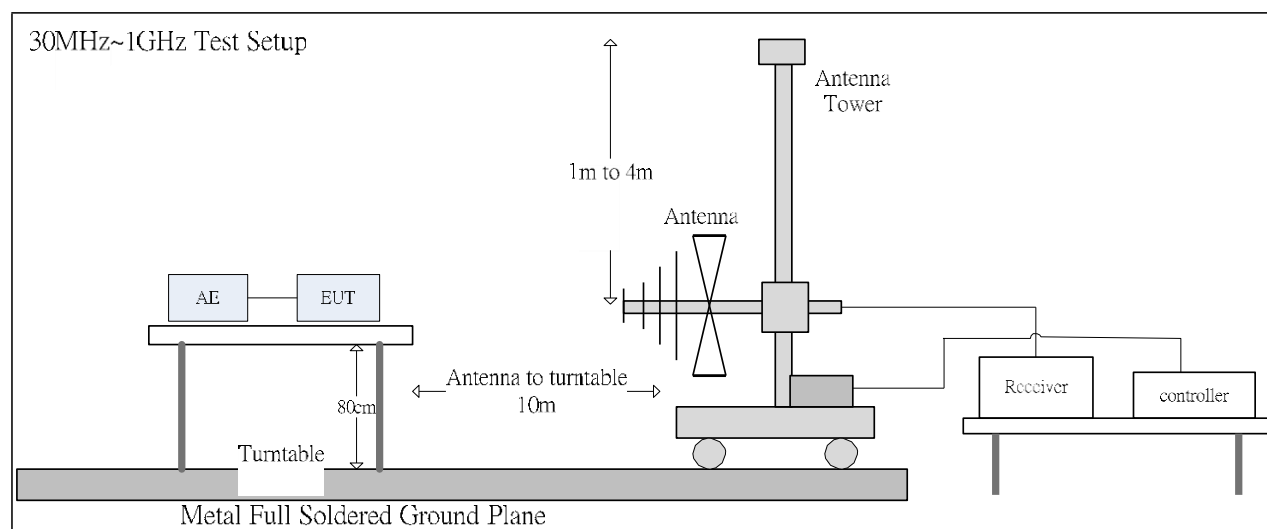
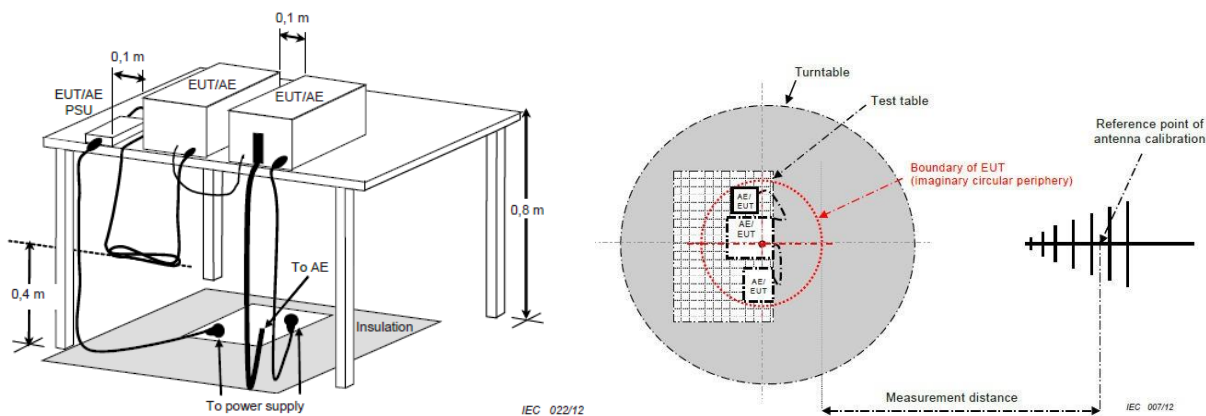

The 3dB beam width of the horn antenna used for the test is as shown in the table below.

Frequency (GHz)	E-plane	H-plane	$\theta_{3\text{dB}}(\text{min})$	d= 3 m
				w (m)
1	88°	147°	88°	5.79
2	68°	119°	68°	4.04
3	73°	92°	73°	4.44
4	70°	89°	70°	4.20
5	55°	60°	55°	3.12
6	63°	62°	62°	3.60

4.1.2 Test Procedure

The radiated emissions test will then be repeated on the open site or chamber to measure the amplitudes accurately and without the multiple reflections existing in the shielded room. The EUT and support equipment are set up on the turntable of one of 10 meter open field sites or 10 meter chamber. Desktop EUT are set up on a FRP stand 0.8 meter above the ground or floor-standing arrangement shall be placed on the horizontal ground reference plane.

For the initial measurements, the receiving antenna is varied from 1-4 meter height and is changed in the vertical plane from vertical to horizontal polarization at each frequency. The highest emissions between 30 MHz to 1000 MHz were analyzed in details by operating the spectrum analyzer and/or EMI receiver in quasi-peak mode to determine the precise amplitude of the emissions. The highest emissions between 1 GHz to 6 GHz were analyzed in details by operating the spectrum analyzer in peak and average mode to determine the precise amplitude of the emissions. The test volume for a height of up to 30 cm may be obstructed by absorber placed on the ground plane.

At the highest amplitudes observed, the EUT is rotated in the horizontal plane while changing the antenna polarization in the vertical plane to maximize the reading. The interconnecting cables were arranged and moved to get the maximum measurement. Once the maximum reading is obtained, the antenna elevation and polarization will be varied between specified limits to maximize the readings. All of the interface cables were manipulated according to EN 55032 requirements.

The highest internal source of an EUT is defined as the highest frequency generated or used within the EUT or on which the EUT operates or tunes.

If the highest frequency of the internal sources of the EUT is less than 108 MHz, the measurement shall only be made up to 1 GHz.

If the highest frequency of the internal sources of the EUT is between 108 MHz and 500 MHz, the measurement shall only be made up to 2 GHz.

If the highest frequency of the internal sources of the EUT is between 500 MHz and 1 GHz, the measurement shall only be made up to 5 GHz.

If the highest frequency of the internal sources of the EUT is above 1 GHz, the measurement shall be made up to 5 times the highest frequency or 6 GHz, whichever is less.

4.1.3 Spectrum Analyzer Configuration (for the frequencies tested)

Frequency Range: 30MHz--1000MHz
 Detector Function: Quasi-Peak Mode
 Resolution Bandwidth: 120KHz

Frequency Range: Above 1 GHz to 6 GHz
 Detector Function: Peak/Average Mode
 Resolution Bandwidth: 1MHz

4.2 Limit

Radiated emissions at frequencies up to 1 GHz for Class A equipment:

Frequency range MHz	Measurement		Class A limits dB(μ V/m)
	Distance m	Detector type/ bandwidth	OATS/SAC (see Table A.1)
30 – 230	10	Quasi Peak / 120 kHz	40
230 – 1 000			47
30 – 230	3		50
230 – 1 000			57

Radiated emissions at frequencies above 1 GHz for Class A equipment:

Frequency range MHz	Measurement		Class A limits dB(μ V/m)
	Distance m	Detector type/ bandwidth	FSOATS (see Table A.1)
1 000 – 3 000	3	Average / 1 MHz	56
3 000 – 6 000			60
1 000 – 3 000		Peak / 1 MHz	76
3 000 – 6 000			80

Radiated emissions at frequencies up to 1 GHz for Class B equipment:

Frequency range MHz	Measurement		Class B limits dB(μ V/m)
	Distance m	Detector type/ bandwidth	OATS/SAC (see Table A.1)
30 – 230	10	Quasi Peak / 120 kHz	30
230 – 1 000			37
30 – 230	3		40
230 – 1 000			47

Radiated emissions at frequencies above 1 GHz for Class B equipment:

Frequency range MHz	Measurement		Class B limits dB(μ V/m)
	Distance m	Detector type/ bandwidth	FSOATS (see Table A.1)
1 000 – 3 000	3	Average/ 1 MHz	50
3 000 – 6 000			54
1 000 – 3 000		Peak/ 1 MHz	70
3 000 – 6 000			74

Radiated emissions from FM receivers:

Frequency range MHz	Measurement		Class B limit dB(μ V/m)		
	Distance m	Detector type/ bandwidth	Fundamental	Harmonics	
			OATS/SAC (see Table A.1)	OATS/SAC (see Table A.1)	
30 – 230	10	Quasi peak/ 120 kHz	50	42	
230 – 300				42	
300 – 1 000				46	
30 – 230	3		Quasi peak/ 120 kHz	60	52
230 – 300					52
300 – 1 000					56

4.3 Radiation Test Data: Configuration 1

Table 4.3.1 Radiated Emissions (Horizontal)

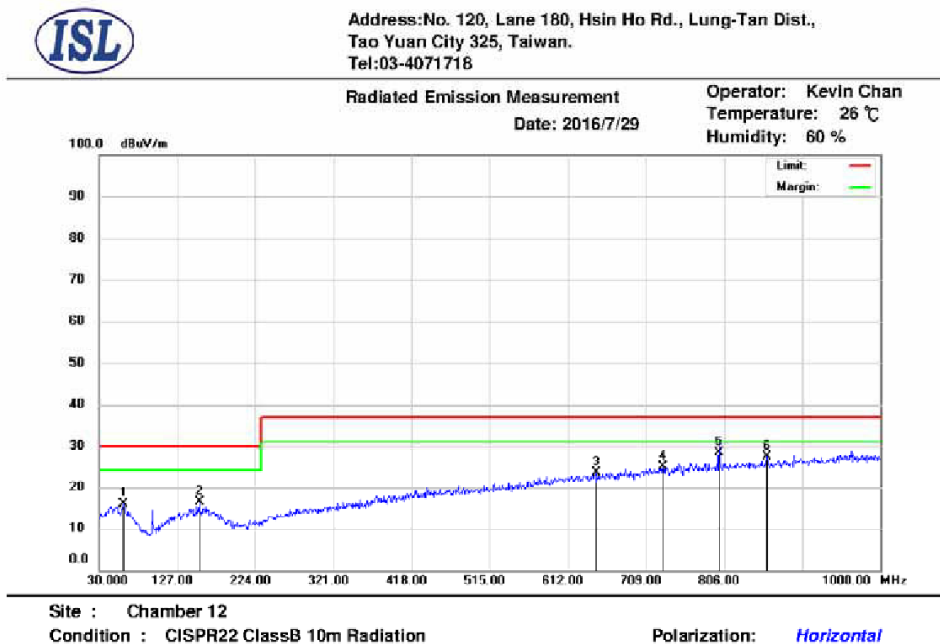

Mk.	Frequency (MHz)	RX F (dBUV)	Correct Factor(dB/m)	Emission (dBUV/m)	Limit (dBUV/m)	Margin (dB)	Ant.Pos (cm)	Tab.Pos (deg.)	Detector
1	60.07	33.29	-17.53	15.76	30.00	-14.24	119	290	peak
2	154.16	32.26	-16.00	16.26	30.00	-13.74	142	169	peak
3	646.92	30.61	-7.22	23.39	37.00	-13.61	251	91	peak
4	730.34	30.66	-5.80	24.86	37.00	-12.14	384	235	peak
5	800.02	33.35	-4.85	28.50	37.00	-8.50	334	145	QP
6	859.35	31.63	-4.29	27.34	37.00	-9.66	177	268	peak

* Note:

Margin = Emission – Limit

Emission = Radiated Amplitude + Correct Factor

Correct Factor = Antenna Correction Factor + Cable Loss

A margin of -8dB means that the emission is 8dB below the limit

BILOG Antenna Distance: 10 meters

Below 1GHz test, if the peak measured value meets the QP limit, it is unnecessary to perform the QP measurement.



Address: No. 120, Lane 180, Hsin Ho Rd., Lung-Tan Dist.,
Tao Yuan City 325, Taiwan.
Tel: 03-4071718

Radiated Emission Measurement
Date: 2016/7/29

Operator: Jerry
Temperature: 26 °C
Humidity: 60 %

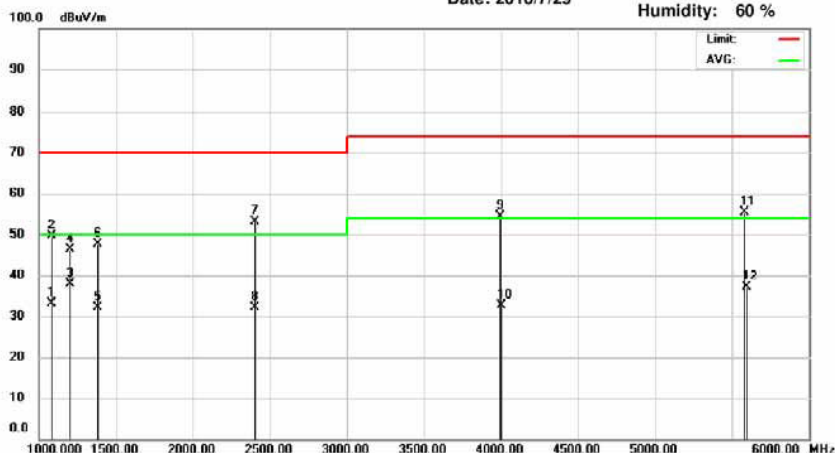

Site : Chamber 14

Condition : CISPR22 ClassB Radiation(Peak)

Polarization: *Horizontal*

Mk.	Frequency (MHz)	RX_R (dBuV)	Correct Factor(dB/m)	Emission (dBuV/m)	Limit (dBuV/m)	Margin (dB)	Ant.Pos (cm)	Tab.Pos (deg.)	Detector
1	1084.70	49.05	-15.90	33.15	50.00	-16.85	143	71	AVG
2	1085.00	65.57	-15.90	49.67	70.00	-20.33	388	63	peak
3	1199.82	53.74	-15.84	37.90	50.00	-12.10	100	72	AVG
4	1200.00	62.28	-15.84	46.44	70.00	-23.56	100	190	peak
5	1381.05	47.80	-15.74	32.06	50.00	-17.94	134	88	AVG
6	1385.00	63.40	-15.73	47.67	70.00	-22.33	214	244	peak
7	2400.00	64.07	-11.02	53.05	70.00	-16.95	100	327	peak
8	2400.10	43.18	-11.02	32.16	50.00	-17.84	138	56	AVG
9	3995.00	63.09	-8.69	54.40	74.00	-19.60	328	259	peak
10	3995.95	41.43	-8.69	32.74	54.00	-21.26	186	0	AVG
11	5585.00	62.93	-7.61	55.32	74.00	-18.68	206	262	peak
12	5590.50	44.68	-7.61	37.07	54.00	-16.93	102	358	AVG

* Note:

Margin = Emission - Limit

Emission = Radiated Amplitude + Correct Factor

Correct Factor = Antenna Correction Factor + Cable Loss - Pre-Amplifier Gain

A margin of -8dB means that the emission is 8dB below the limit

Horn Antenna Distance: 3 meters

Above 1GHz test, if the peak measured value meets the average limit, it is unnecessary to perform the average measurement.

Table 4.3.2 Radiated Emissions (Vertical)



Address: No. 120, Lane 180, Hsin Ho Rd., Lung-Tan Dist.,
Tao Yuan City 325, Taiwan.
Tel: 03-4071718

Radiated Emission Measurement
Date: 2016/7/29

Operator: Kevin Chan
Temperature: 26 °C
Humidity: 60 %

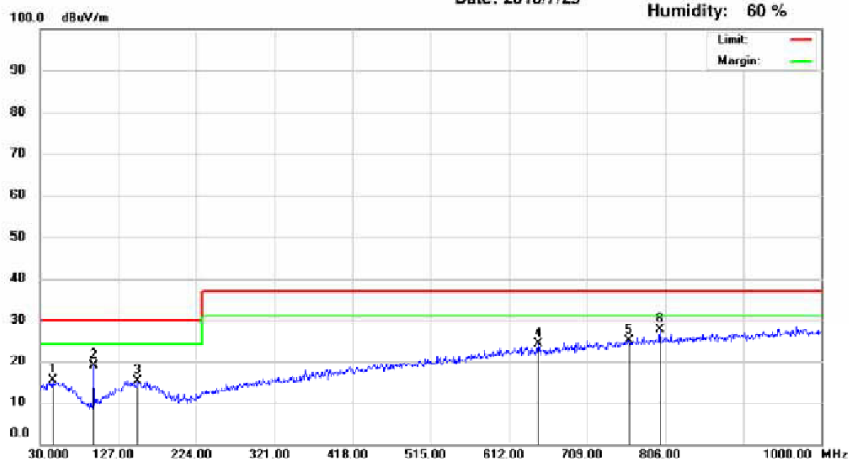

Site : Chamber 12

Condition : CISPR22 ClassB 10m Radiation

Polarization: Vertical

Mk.	Frequency (MHz)	RX_R (dBuV)	Correct Factor(dB/m)	Emission (dBuV/m)	Limit (dBuV/m)	Margin (dB)	Ant.Pos (cm)	Tab.Pos (deg.)	Detector
1	45.52	32.42	-17.14	15.28	30.00	-14.72	265	168	peak
2	95.96	40.71	-21.77	18.94	30.00	-11.06	100	35	peak
3	151.25	31.21	-16.12	15.09	30.00	-14.91	100	293	peak
4	648.86	31.22	-7.20	24.02	37.00	-12.98	152	289	peak
5	761.38	30.23	-5.26	24.97	37.00	-12.03	100	350	peak
6	800.18	32.43	-4.85	27.58	37.00	-9.42	380	1	peak

* Note:

Margin = Emission – Limit

Emission = Radiated Amplitude + Correct Factor

Correct Factor = Antenna Correction Factor + Cable Loss

A margin of -8dB means that the emission is 8dB below the limit

BILOG Antenna Distance: 10 meters

Below 1GHz test, if the peak measured value meets the QP limit, it is unnecessary to perform the QP measurement.



Address: No. 120, Lane 180, Hsin Ho Rd., Lung-Tan Dist.,
Tao Yuan City 325, Taiwan.
Tel: 03-4071718

Radiated Emission Measurement
Date: 2016/7/29

Operator: Jerry
Temperature: 26 °C
Humidity: 60 %

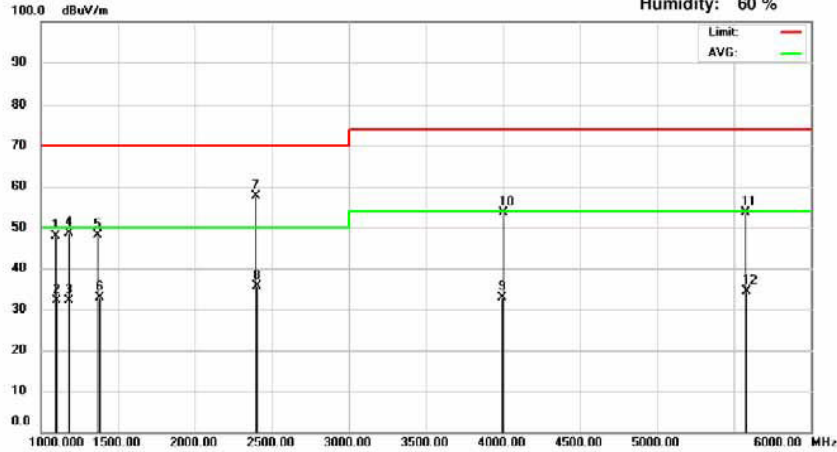

Site : Chamber 14

Condition : CISPR22 ClassB Radiation(Peak)

Polarization: Vertical

Mk.	Frequency (MHz)	RX_R (dBuV)	Correct Factor(dB/m)	Emission (dBuV/m)	Limit (dBuV/m)	Margin (dB)	Ant.Pos (cm)	Tab.Pos (deg.)	Detector
1	1095.00	63.74	-15.90	47.84	70.00	-22.16	397	282	peak
2	1095.38	47.96	-15.90	32.06	50.00	-17.94	100	360	AVG
3	1183.65	48.09	-15.85	32.24	50.00	-17.76	148	0	AVG
4	1185.00	64.40	-15.85	48.55	70.00	-21.45	313	92	peak
5	1370.00	63.81	-15.74	48.07	70.00	-21.93	313	339	peak
6	1376.90	48.62	-15.74	32.88	50.00	-17.12	122	0	AVG
7	2395.00	68.67	-11.04	57.63	70.00	-12.37	169	198	peak
8	2400.30	46.75	-11.02	35.73	50.00	-14.27	116	351	AVG
9	3991.70	41.54	-8.70	32.84	54.00	-21.16	158	322	AVG
10	4000.00	62.24	-8.68	53.56	74.00	-20.44	105	231	peak
11	5575.00	61.32	-7.62	53.70	74.00	-20.30	265	235	peak
12	5576.30	41.96	-7.62	34.34	54.00	-19.66	100	191	AVG

* Note:

Margin = Emission - Limit

Emission = Radiated Amplitude + Correct Factor

Correct Factor = Antenna Correction Factor + Cable Loss - Pre-Amplifier Gain

A margin of -8dB means that the emission is 8dB below the limit

Horn Antenna Distance: 3 meters

Above 1GHz test, if the peak measured value meets the average limit, it is unnecessary to perform the average measurement.

4.4 Radiation Test Data: Configuration 2

Table 4.4.1 Radiated Emissions (Horizontal)

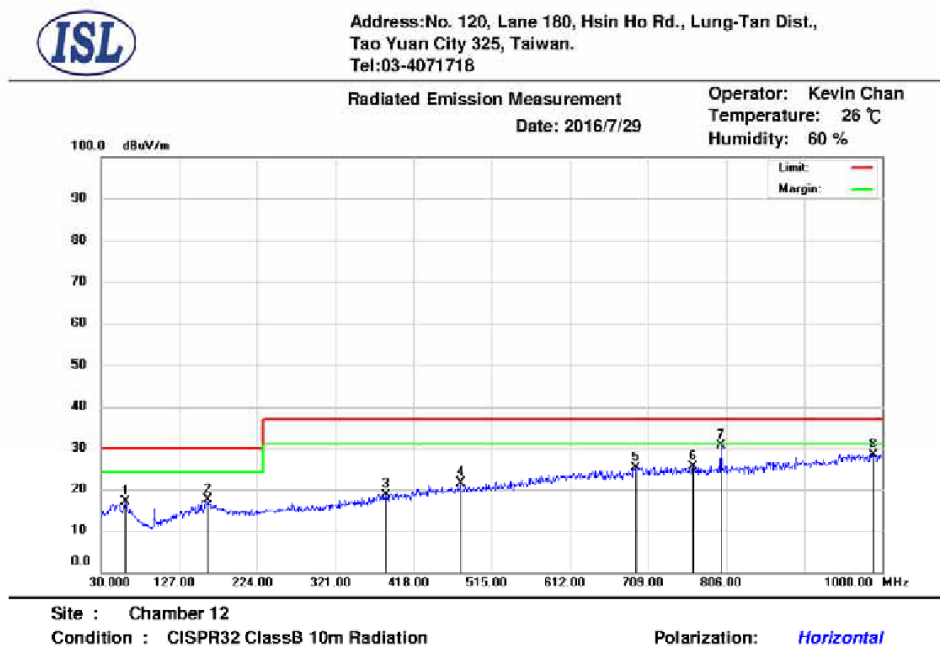

Mk.	Frequency (MHz)	RX F (dBUV)	Correct Factor(dB/m)	Emission (dBUV/m)	Limit (dBUV/m)	Margin (dB)	Ant.Pos (cm)	Tab.Pos (deg.)	Detector
1	60.07	34.29	-17.53	16.76	30.00	-13.24	100	226	peak
2	162.89	33.23	-15.89	17.34	30.00	-12.66	193	58	peak
3	364.05	31.39	-12.71	18.68	37.00	-18.32	100	347	peak
4	476.20	31.86	-10.47	21.39	37.00	-15.61	263	354	peak
5	694.45	31.58	-6.51	25.07	37.00	-11.93	320	148	peak
6	765.26	30.48	-5.21	25.27	37.00	-11.73	391	285	peak
7	800.18	35.45	-4.85	30.60	37.00	-6.40	100	238	peak
8	989.33	30.84	-2.38	28.46	37.00	-8.54	100	242	peak

* Note:

Margin = Emission – Limit

Emission = Radiated Amplitude + Correct Factor

Correct Factor = Antenna Correction Factor + Cable Loss

A margin of -8dB means that the emission is 8dB below the limit

BILOG Antenna Distance: 10 meters

Below 1GHz test, if the peak measured value meets the QP limit, it is unnecessary to perform the QP measurement.



Address: No. 120, Lane 180, Hsin Ho Rd., Lung-Tan Dist.,
Tao Yuan City 325, Taiwan.
Tel: 03-4071718

Radiated Emission Measurement
Date: 2016/7/29

Operator: Jerry
Temperature: 26 °C
Humidity: 60 %

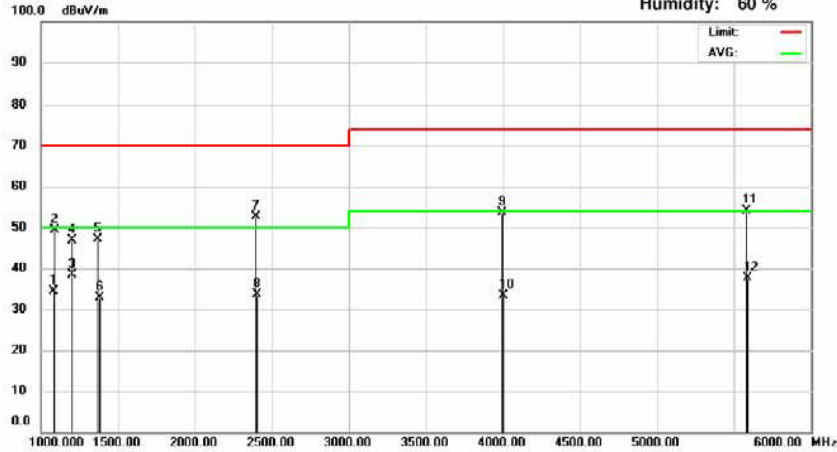

Site : Chamber 14

Condition : CISPR22 ClassB Radiation(Peak)

Polarization: *Horizontal*

Mk.	Frequency (MHz)	RX_R (dBuV)	Correct Factor(dB/m)	Emission (dBuV/m)	Limit (dBuV/m)	Margin (dB)	Ant.Pos (cm)	Tab.Pos (deg.)	Detector
1	1084.76	50.23	-15.90	34.33	50.00	-15.67	117	84	AVG
2	1090.00	65.34	-15.91	49.43	70.00	-20.57	100	127	peak
3	1199.68	54.13	-15.84	38.29	50.00	-11.71	128	76	AVG
4	1200.00	62.81	-15.84	46.97	70.00	-23.03	258	86	peak
5	1370.00	62.96	-15.74	47.22	70.00	-22.78	211	151	peak
6	1376.34	48.65	-15.74	32.91	50.00	-17.09	178	48	AVG
7	2395.00	63.68	-11.04	52.64	70.00	-17.36	100	16	peak
8	2400.15	44.70	-11.02	33.68	50.00	-16.32	100	297	AVG
9	3995.00	62.44	-8.69	53.75	74.00	-20.25	105	211	peak
10	3995.20	42.19	-8.69	33.50	54.00	-20.50	203	0	AVG
11	5580.00	61.85	-7.62	54.23	74.00	-19.77	100	357	peak
12	5589.40	45.18	-7.61	37.57	54.00	-16.43	382	324	AVG

* Note:

Margin = Emission – Limit

Emission = Radiated Amplitude + Correct Factor

Correct Factor = Antenna Correction Factor + Cable Loss – Pre-Amplifier Gain

A margin of -8dB means that the emission is 8dB below the limit

Horn Antenna Distance: 3 meters

Above 1GHz test, if the peak measured value meets the average limit, it is unnecessary to perform the average measurement.

Table 4.4.2 Radiated Emissions (Vertical)

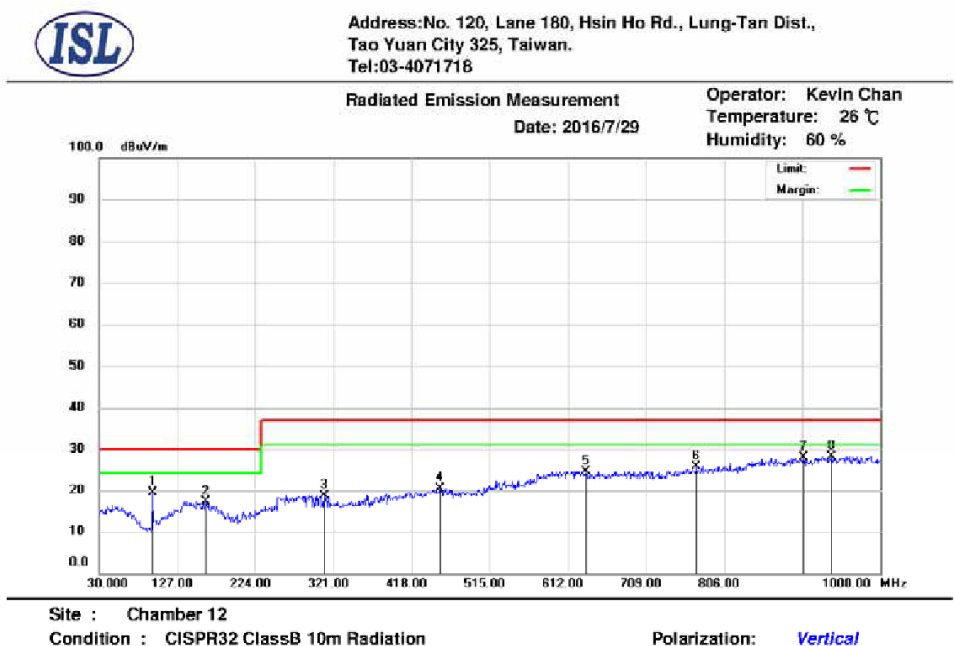

Mk.	Frequency (MHz)	RX_R (dBuV)	Correct Factor(dB/m)	Emission (dBuV/m)	Limit (dBuV/m)	Margin (dB)	Ant.Pos (cm)	Tab.Pos (deg.)	Detector
1	95.96	41.21	-21.77	19.44	30.00	-10.56	100	264	peak
2	162.89	32.95	-15.89	17.06	30.00	-12.94	356	271	peak
3	309.36	33.22	-14.59	18.63	37.00	-18.37	148	203	peak
4	452.92	31.30	-10.86	20.44	37.00	-16.56	100	88	peak
5	634.31	31.77	-7.32	24.45	37.00	-12.55	285	350	peak
6	772.05	30.68	-5.14	25.54	37.00	-11.46	102	207	peak
7	904.94	31.69	-3.71	27.98	37.00	-9.02	341	330	peak
8	939.86	31.22	-2.99	28.23	37.00	-8.77	100	258	peak

* Note:

Margin = Emission – Limit

Emission = Radiated Amplitude + Correct Factor

Correct Factor = Antenna Correction Factor + Cable Loss

A margin of -8dB means that the emission is 8dB below the limit

BILOG Antenna Distance: 10 meters

Below 1GHz test, if the peak measured value meets the QP limit, it is unnecessary to perform the QP measurement.



Address: No. 120, Lane 180, Hsin Ho Rd., Lung-Tan Dist.,
Tao Yuan City 325, Taiwan.
Tel: 03-4071718

Radiated Emission Measurement
Date: 2016/7/29

Operator: Jerry
Temperature: 26 °C
Humidity: 60 %

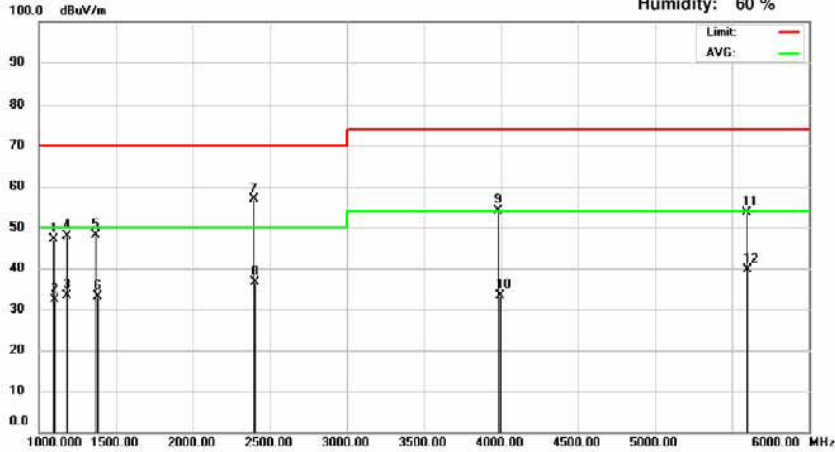

Site : Chamber 14

Condition : CISPR22 ClassB Radiation(Peak)

Polarization: Vertical

Mk.	Frequency (MHz)	RX_R (dBuV)	Correct Factor(dB/m)	Emission (dBuV/m)	Limit (dBuV/m)	Margin (dB)	Ant.Pos (cm)	Tab.Pos (deg.)	Detector
1	1095.00	62.97	-15.90	47.07	70.00	-22.93	256	27	peak
2	1096.00	48.32	-15.90	32.42	50.00	-17.58	100	358	AVG
3	1184.77	49.17	-15.85	33.32	50.00	-16.68	100	0	AVG
4	1185.00	63.78	-15.85	47.93	70.00	-22.07	142	256	peak
5	1370.00	63.81	-15.74	48.07	70.00	-21.93	180	155	peak
6	1378.98	48.97	-15.74	33.23	50.00	-16.77	128	3	AVG
7	2395.00	68.04	-11.04	57.00	70.00	-13.00	100	282	peak
8	2400.62	47.59	-11.02	36.57	50.00	-13.43	120	344	AVG
9	3985.00	62.83	-8.71	54.12	74.00	-19.88	302	236	peak
10	3994.92	42.08	-8.69	33.39	54.00	-20.61	117	335	AVG
11	5595.00	61.14	-7.58	53.56	74.00	-20.44	335	141	peak
12	5599.68	47.31	-7.58	39.73	54.00	-14.27	123	249	AVG

* Note:

Margin = Emission - Limit

Emission = Radiated Amplitude + Correct Factor

Correct Factor = Antenna Correction Factor + Cable Loss - Pre-Amplifier Gain

A margin of -8dB means that the emission is 8dB below the limit

Horn Antenna Distance: 3 meters

Above 1GHz test, if the peak measured value meets the average limit, it is unnecessary to perform the average measurement.

4.5 Test Setup Photo

Front View (30MHz~1GHz)



Back View (30MHz~1GHz)

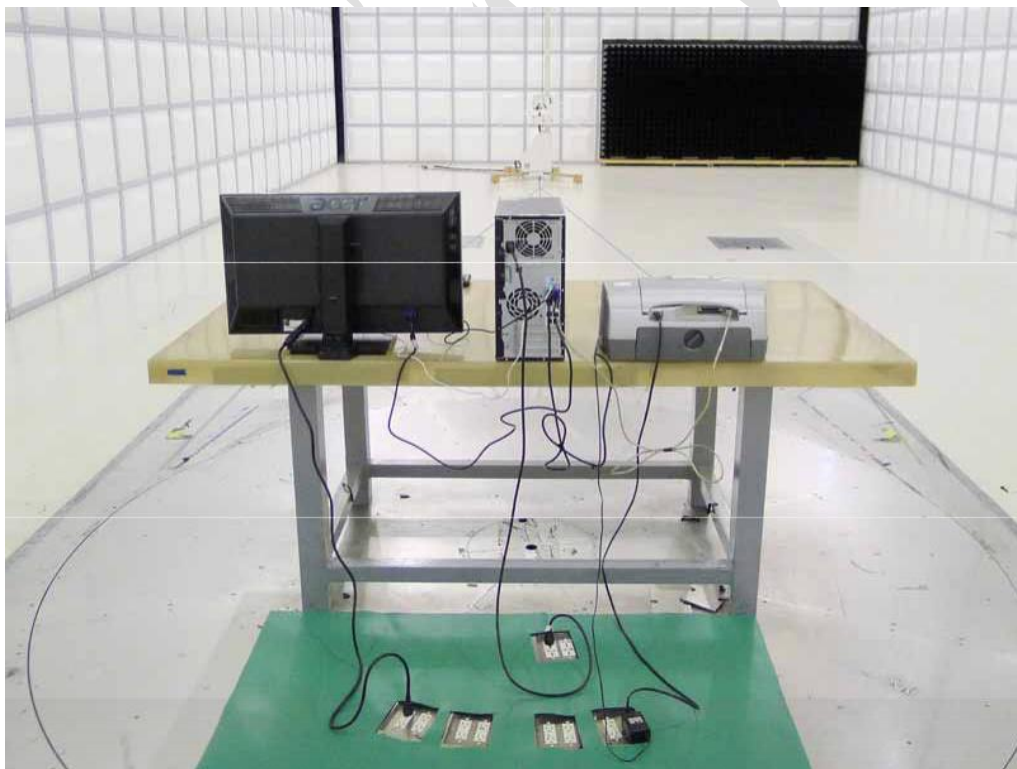

Front View (above 1GHz)

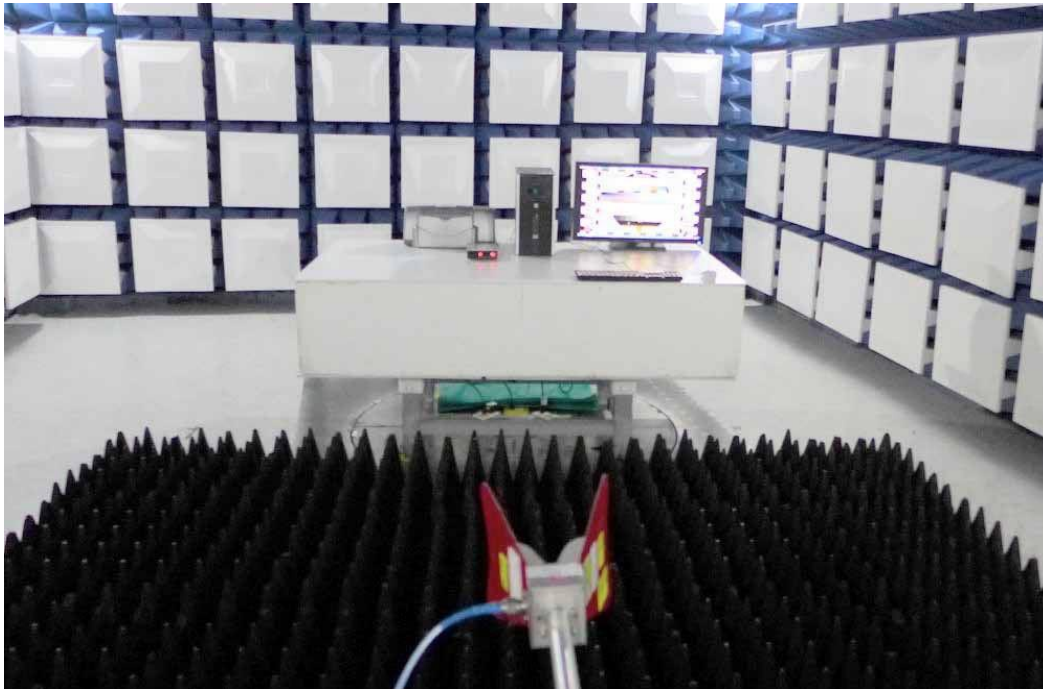

Back View (above 1GHz)

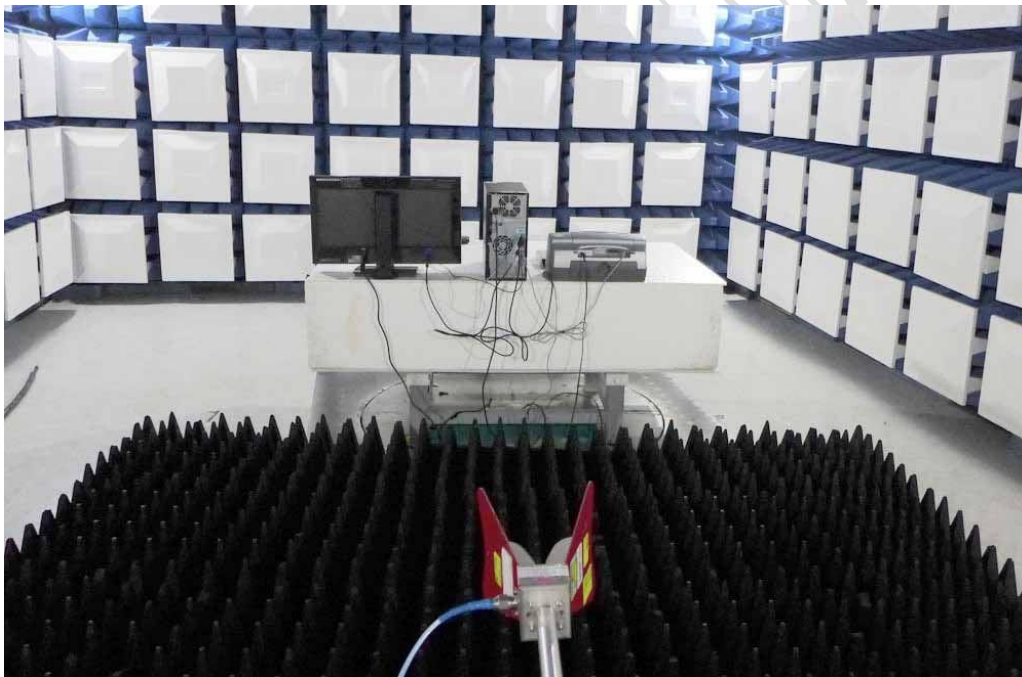

5. Electrostatic discharge (ESD) immunity

5.1 Test Specification and Setup

5.1.1 Test Specification

Port:	Enclosure
Basic Standard:	EN 61000-4-2/ IEC 61000-4-2 (details referred to Sec 1.2)
Test Level:	Air +/- 2 kV, +/- 4 kV, +/- 8 kV Contact +/- 4 kV
Criteria:	B
Test Procedure	refer to ISL QA -T4-E-S7
Temperature:	20 °C
Humidity:	40%

Selected Test Point

Air: discharges were applied to slots, aperture or insulating surfaces. 10 single air discharges were applied to each selected points.

Contact: Total 200 discharges minimum were to the selected contact points.

Indirect Contact Points: 25 discharges were applied to center of one edge of VCP and each EUT side of HCP with 10 cm away from EUT.

5.1.2 Test Setup

EUT is 1m from the wall and other metallic structure. When Battery test mode is needed, a cable with one 470KΩ resistor at two rare ends is connected from metallic part of EUT and screwed to HCP.

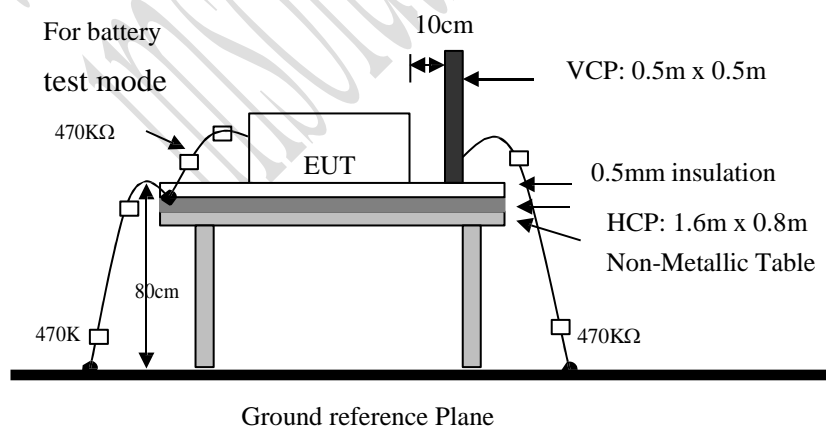

5.1.3 Test Result

Performance of EUT complies with the given specification.

5.2 Test Point

Red arrow lines indicate the contact points, and blue arrow lines indicate the air points.



5.3 Test Setup Photo



6. Radio-Frequency, Electromagnetic Field immunity

6.1 Test Specification and Setup

6.1.1 Test Specification

Port:	Enclosure
Basic Standard:	EN 61000-4-3/ IEC 61000-4-3 (details referred to Sec 1.2)
Test Level:	3 V/m
Modulation:	AM 1KHz 80%
Frequency range:	80 MHz~1 GHz
Frequency Step:	1% of last step frequency
Dwell time:	3s
Polarization:	Vertical and Horizontal
EUT Azimuth Angle	☒0° ☒90° ☒180° ☒270°
Criteria:	A
Test Procedure	refer to ISL QA -T4-E-S8
Temperature:	26°C
Humidity:	55%

6.1.2 Test Setup

The field sensor is placed at one calibration grid point to check the intensity of the established fields on both polarizations. EUT is adjusted to have each side of EUT face coincident with the calibration plane. A CCD camera and speakers are used to monitor the condition of EUT for the performance judgment.

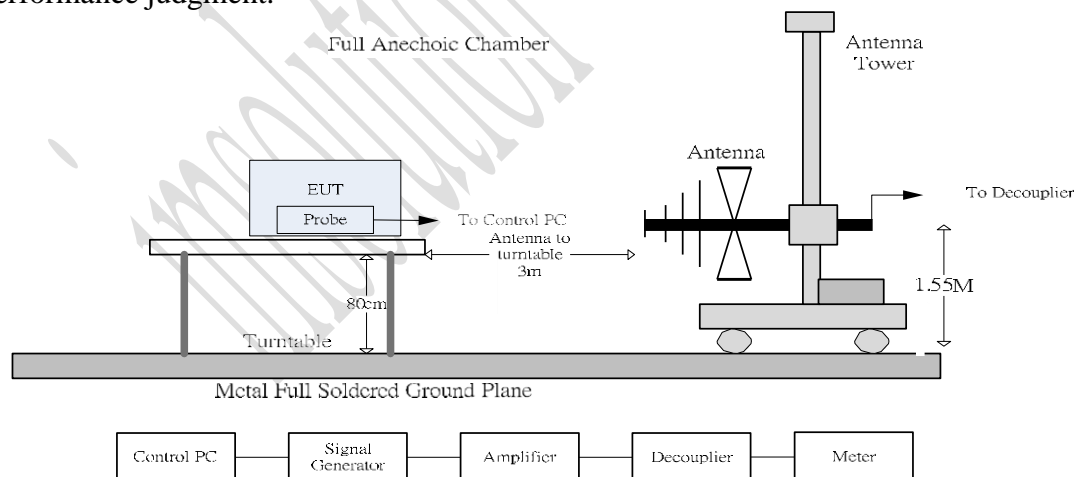

6.1.3 Test Result

Performance of EUT complies with the given specification.

6.2 Test Setup Photo

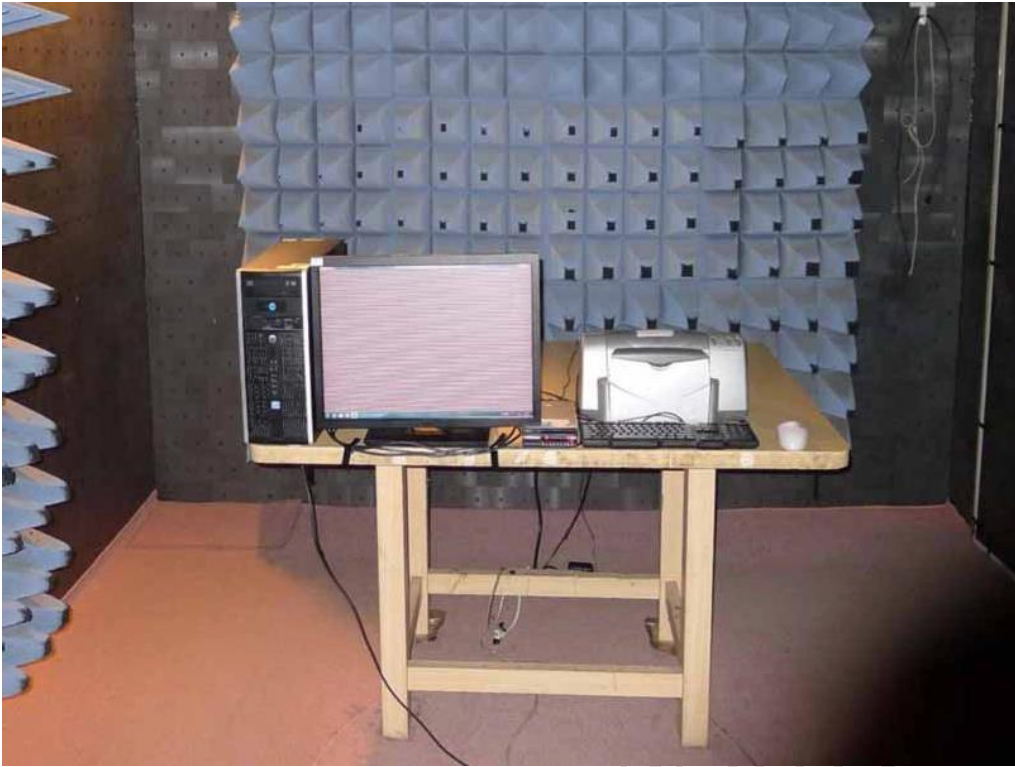

7. Power Frequency Magnetic Field immunity

7.1 Test Specification and Setup

7.1.1 Test Specification

Port:	Enclosure
Basic Standard:	EN 61000-4-8/ IEC 61000-4-8 (details referred to Sec 1.2)
Test Level:	1A/m
Polarization:	X, Y, Z
Criteria:	A
Test Procedure	refer to ISL QA -T4-E-S12
Temperature:	26°C
Humidity:	55%

7.1.2 Test Setup

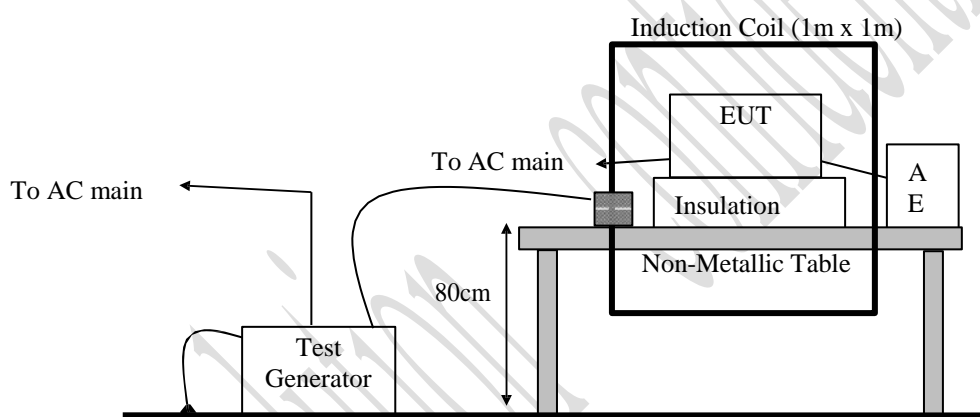

7.1.3 Test Result

Performance of EUT complies with the given specification.

7.2 Test Setup Photo



8. Harmonics

8.1 Test Specification and Setup

8.1.1 Test Specification

Port:	AC mains
Active Input Power:	<75W
Basic Standard:	EN61000-3-2/IEC 61000-3-2 (details referred to Sec 1.2)
Test Duration:	2.5min
Class:	D
Test Procedure	refer to ISL QA -T4-E-S14
Temperature:	26°C
Humidity:	55%

Test Procedure

The EUT is supplied in series with shunts or current transformers from a source having the same nominal voltage and frequency as the rated supply voltage and frequency of the EUT. The EUT is configured to its rated current with additional resistive load when the testing is performed.

Equipment having more than one rated voltage shall be tested at the rated voltage producing the highest harmonics as compared with the limits.

8.1.2 Test Setup

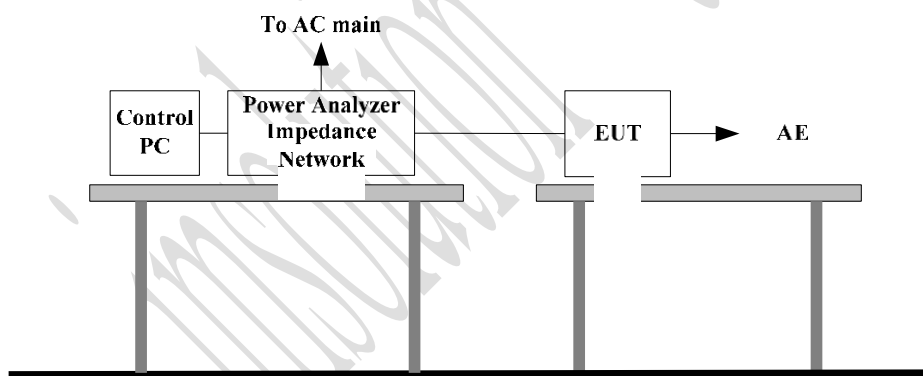

8.1.3 Limit

Limits of Class A Harmonics Currents

Harmonics Order n	Maximum Permissible harmonic current A	Harmonics Order n	Maximum Permissible harmonic current A
Odd harmonics		Even harmonics	
3	2.30	2	1.08
5	1.14	4	0.43
7	0.77	6	0.30
9	0.40	8 ≤ n ≤ 40	0.23 * 8/n
11	0.33		
13	0.21		
15 ≤ n ≤ 39	0.15 * 15/n		

Limits of Class D Harmonics Currents

Harmonics Order N	Maximum Permissible harmonic current per watt mA/W	Maximum Permissible harmonic current A
3	3.4	2.30
5	1.9	1.14
7	1.0	0.77
9	0.5	0.40
11	0.35	0.33
13 ≤ n ≤ 39 (odd harmonics only)	3.85/n	See limit of Class A

8.1.4 Test Result

Active input power under 75W, no limit apply, declare compliance

9. Voltage Fluctuations

9.1 Test Specification and Setup

9.1.1 Test Specification

Port:	AC mains
Basic Standard:	EN61000-3-3/IEC61000-3-3 (details referred to Sec 1.2)
Test Procedure	refer to ISL QA -T4-E-S14
Observation period:	For Pst 10min
	For Plt 2 hours
Temperature:	26°C
Humidity:	55%

Test Procedure

The EUT is supplied in series with reference impedance from a power source with the voltage and frequency as the nominal supply voltage and frequency of the EUT.

9.1.2 Test Setup

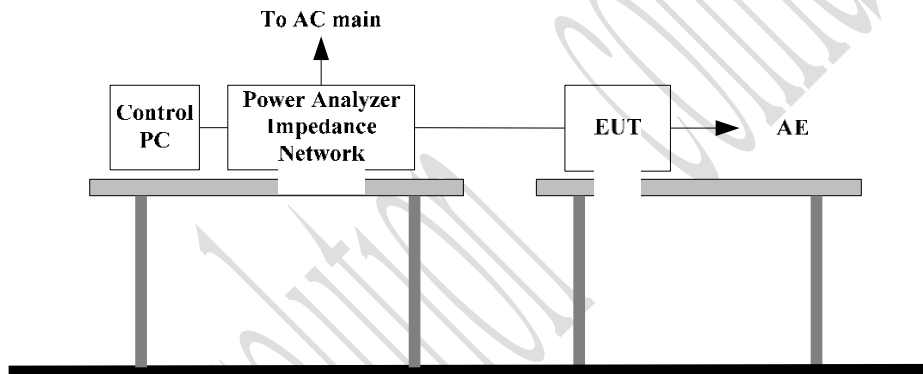

9.1.3 Test Result

Performance of EUT complies with the given specification.

9.2 Test Data

Flicker Test Summary per EN/IEC61000-3-3 Ed. 3.0 (2013) (Run time)

Test duration (min): 120

Data file name: CTSMXL_F-001413.cts_data

Test Result: Pass

Status: Test Completed

Pst_i and limit line

European Limits

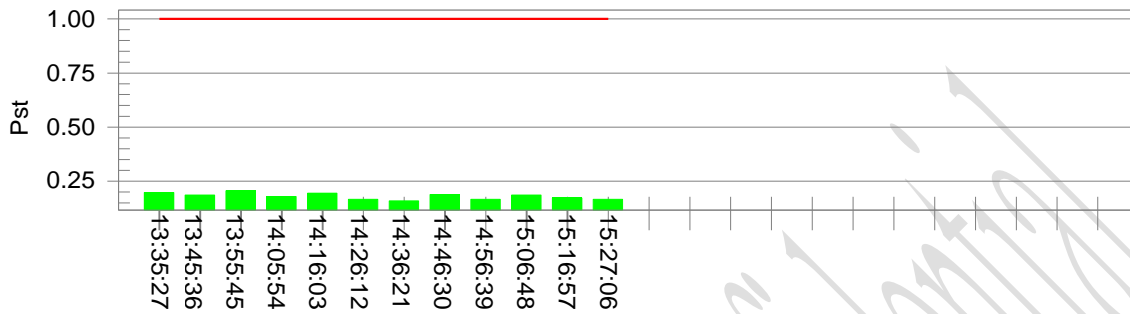

Plt and limit line



Parameter values recorded during the test:

Vrms at the end of test (Volt):	229.82		
Highest dt (%):	0.00	Test limit (%):	N/A
T-max (mS):	0.0	Test limit (mS):	500.0
Highest dc (%):	0.00	Test limit (%):	3.30
Highest dmax (%):	0.14	Test limit (%):	4.00
Highest Pst (10 min. period):	0.206	Test limit:	1.000
Highest Plt (2 hr. period):	0.182	Test limit:	0.650
			Pass

9.3 Test Setup Photo



10. Appendix

10.1 Appendix A: Test Equipment

10.1.1 Test Equipment List

Location Con02	Equipment Name	Brand	Model	S/N	Last Cal. Date	Next Cal. Date
Conduction 02	LISN 15	R&S	ENV216	101335	09/18/2015	09/18/2017
Conduction 02	LISN 03	ROHDE&SCHWARZ	ESH3/Z5	828874/010	02/26/2017	02/26/2017
Conduction 02	Conduction 02-1 Cable	WOKEN	CFD 300-NL	Conduction 02 -1	07/17/2017	07/17/2017
Conduction 02	EMI Receiver 14	ROHDE& SCHWARZ	ESCI	101034	05/31/2017	05/31/2017

Location Chmb12	Equipment Name	Brand	Model	S/N	Last Cal. Date	Next Cal. Date
Radiation (Chamber12)	BILOG Antenna 18	Schwarzbeck	Schwarzbeck VULB 9168+EMCI-N -6-05	646	01/11/2017	01/11/2017
Radiation (Chamber12)	Preamplifier 26	EMCI	EMC9135	980297	01/21/2017	01/21/2017
Radiation (Chamber12)	Coaxial Cable Chmb 12-10M-01	PEWC	CFD400-NL	Chmb 12-10M-01	07/17/2017	07/17/2017
Radiation (Chamber12)	EMI Receiver 10	ROHDE & SCHWARZ	ESCI	100567	06/30/2017	06/30/2017

Location Chmb14	Equipment Name	Brand	Model	S/N	Last Cal. Date	Next Cal. Date
Rad. Above 1GHz	Spectrum Analyzer 24 (1G~26.5GHz)	Agilent	N9010A	MY49060537	07/30/2017	07/30/2017
Rad. Above 1GHz	Horn Antenna 06 (1G~18G)	ETS	3117	00066665	11/30/2015	11/30/2017
Rad. Above 1GHz	Preamplifier 13 (1G-18G)	MITEQ	JS44-0010180 0-25-10P-44	1329256	07/28/2017	07/28/2017
Rad. Above 1GHz	Microwave Cable 25 (1G-18G)	EMC Instruments	EMC104-NM- SM-6000	141111	11/25/2015	11/25/2017
Rad. Above 1GHz	Microwave Cable 26 (1G-18G)	EMC Instruments	EMC104-NM- SM-800	141112	11/25/2015	11/25/2017

Location	Equipment Name	Brand	Model	S/N	Last Cal. Date	Next Cal. Date
EN61K-4-2	ESD Gun 06	EM TEST	Dito	V0729102699	07/05/2017	07/05/2017
EN61K-4-3	Broadband Log-Periodic Antenna	AR	AT1080	310698	N/A	N/A
EN61K-4-3	Horn Antenna RF-01	AR	ATS700M11 G	0335864	N/A	N/A
EN61K-4-3	Amplifier 80Mz~1GHz 250W	AR	250W1000A	312494	N/A	N/A
EN61K-4-3	Amplifier 800MHz~4.2GHz 50W	AR	50S1G4M1	312762	N/A	N/A
EN61K-4-3	Amplifier 4.0~8.0GHz 35W	AR	35S4G8AM1	0335752	N/A	N/A
EN61K-4-3	Broadband Coupler 80M~1GHz	Amplifier Research	DC6180A	0341805	N/A	N/A
EN61K-4-3	Coaxial Cable	INSULATED	NPS-4806-23 60-NP3	108599.003.01.03	N/A	N/A
EN61K-4-3	Broadband Coupler 0.8G~4.26GHz	AR	DC7144A	0335226	N/A	N/A
EN61K-4-3	Broadband Coupler 4G~8GHz	AR	DC7350A	0335817	N/A	N/A
EN61K-4-3	Signal Generator 07	ROHDE& SCHWARZ	SMB100A	107780	09/09/2015	09/09/2017
EN61K-4-8	Magnetic Field Immunity Loop	FCC	F-1000-4-8-L-1M	01037	05/17/2017	05/17/2017
EN61K-4-8	Magnetic Field Test Generator	FCC	F-1000-4-8-G-125A	01038	05/17/2017	05/17/2017
EN61K-3-2/3, EN61K-3-11-1 2	(Harmonic/Flicker) MX Series CTSH Compliance Test System	California Instruments	MX60T04GH 10400	72793	06/02/2017	06/02/2017

PS: N/A => The equipment does not need calibration.

1.1.1 Software for Controlling Spectrum/Receiver and Calculating Test Data

Test Item	Filename	Version
EN61000-3-2	California Instruments	CTSMXL 2 <2.9.0 >
EN61000-3-3	California Instruments	CTSMXL 2 <2.9.0 >
EN61000-4-2	N/A	2.0
EN61000-4-3	i2	4.130102k
EN61000-4-8	N/A	

Site	Filename	Version	Issue Date
Conduction/Radiation	EZ EMC	ISL-03A2	3/6/2013

10.2 Appendix B: Uncertainty of Measurement

The measurement uncertainty refers to CISPR 16-4-2:2011. The coverage factor $k = 2$ yields approximately a 95 % level of confidence.

<Conduction 02>

AMN: $\pm 2.88\text{dB}$

<Chamber 12 (10M)>

Horizontal

30MHz~200MHz: $\pm 3.93\text{dB}$

200MHz~1000MHz: $\pm 4.09\text{dB}$

Vertical

30MHz~200MHz: $\pm 4.58\text{dB}$

200MHz~1000MHz: $\pm 3.99\text{dB}$

<Chamber 14 (3M)>

1GHz~6GHz: $\pm 4.94\text{dB}$

<Immunity 02>

Test item	Uncertainty
EN 61000-4-2 (ESD)	
Rise time t_r	\bar{U} 15%
Peak current I_p	\bar{U} %
current at 30 ns	\bar{U} %
current at 60 ns	\bar{U} %
EN 61000-4-3 (RS)	$\pm 2.19\text{dB}$
EN 61000-4-8 (Magnetic)	$\pm 5.59\%$

Test item	Uncertainty	Test item	Uncertainty
EN 61000-3-2 (Harmonics)	$\pm 3.98\%$	EN 61000-3-12 (Harmonics)	Voltage $\pm 0.10\%$ Current $\pm 0.15\%$
EN 61000-3-3 (Fluctuations and Flicker)	$\pm 3.98\%$	EN 61000-3-11 (Fluctuations and Flicker)	Voltage $\pm 0.10\%$ Current $\pm 0.15\%$

IMS Solution Confidential