

GRM31CD80J107ME39#

" # " indicates a package specification code.

Available   Complies with RoHS 

< List of part numbers with package codes >
 GRM31CD80J107ME39L , GRM31CD80J107ME39K , GRM31CD80J107ME39B

Shape

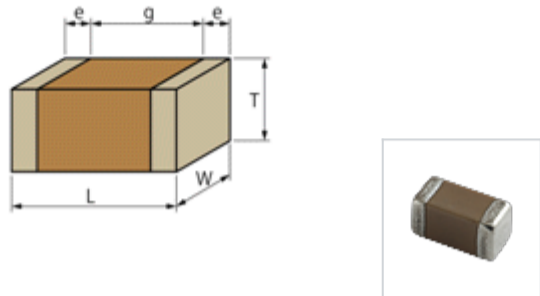

L size	3.2 ± 0.3mm
W size	1.6 ± 0.3mm
T size	1.6 ± 0.3mm
External terminals width e	0.3 to 0.8mm
Distance between external terminals g (Min.)	1.5mm
Size code in mm(inch)	3216 (1206)

Notes

Volt. & temp. derating recommended product

References

Packaging	Specifications	Minimum quantity
L	Embossed tape (180mm)	2000
K	Embossed tape (330mm)	6000
B	Packing in bulk	1000

Mass (typ.)	
1 piece	52mg
Reel (180mm)	160g

Specifications

Capacitance	100µF ± 20%
Rated voltage	6.3Vdc
Temperature characteristics (complied standard)	X6T(EIA)
Capacitance change rate	+22/-33%
Temperature range of temperature characteristics	-55 to 105
Operating temperature range	-55 to 105

Attention

- 1.This datasheet is downloaded from the website of Murata Manufacturing Co., Ltd. Therefore, it ' s specifications are subject to change or our products in it may be discontinued without advance notice. Please check with our sales representatives or product engineers before ordering.
- 2.This datasheet has only typical specifications because there is no space for detailed specifications. Therefore, please review our product specifications or consult the approval sheet for product specifications before ordering.

▪ Frequency characteristics (ESR, Impedance)

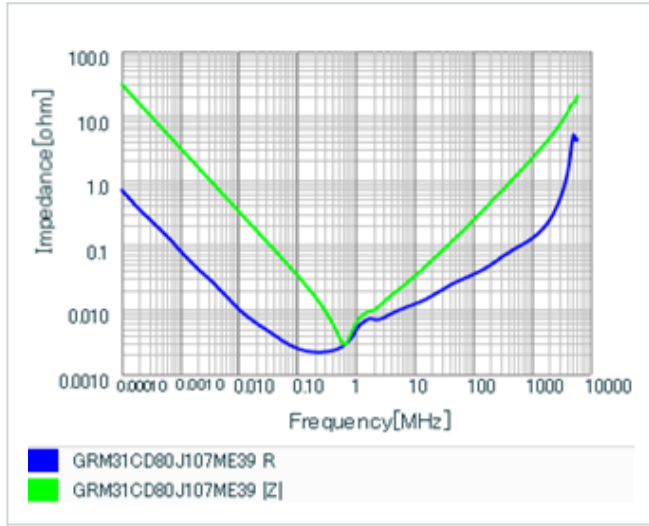

▪ S parameter (Smith chart S11)

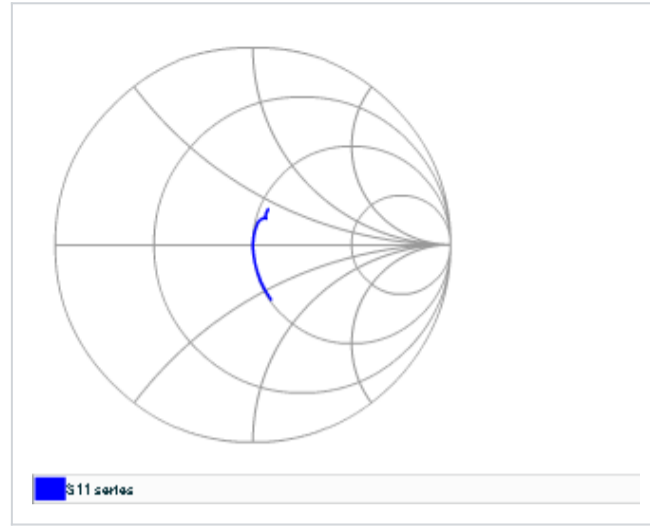

▪ S parameter (Smith chart S21)

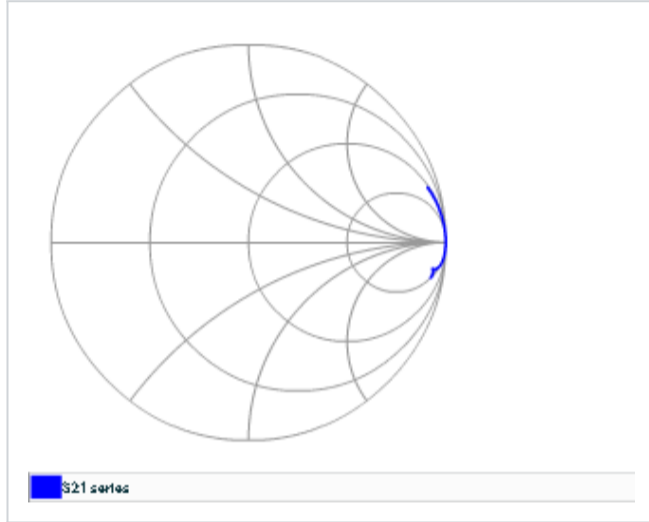

▪ DC bias characteristics

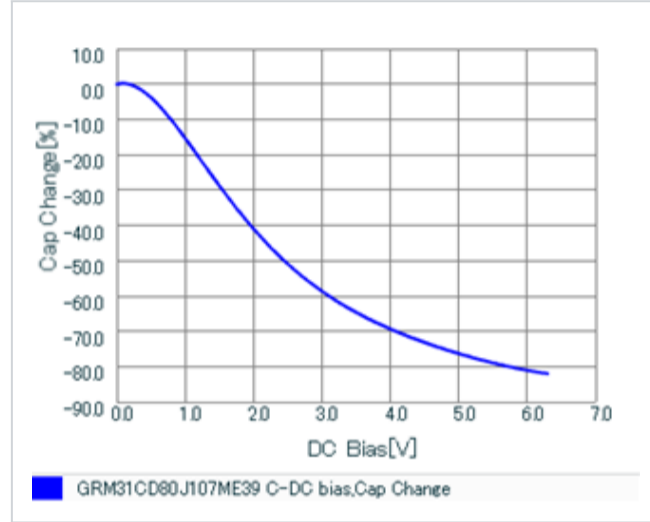

▪ AC voltage characteristics

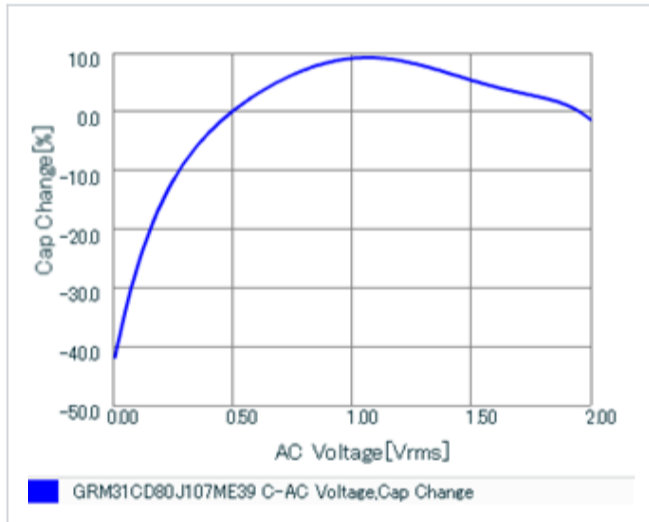

▪ Capacitance - temperature characteristics

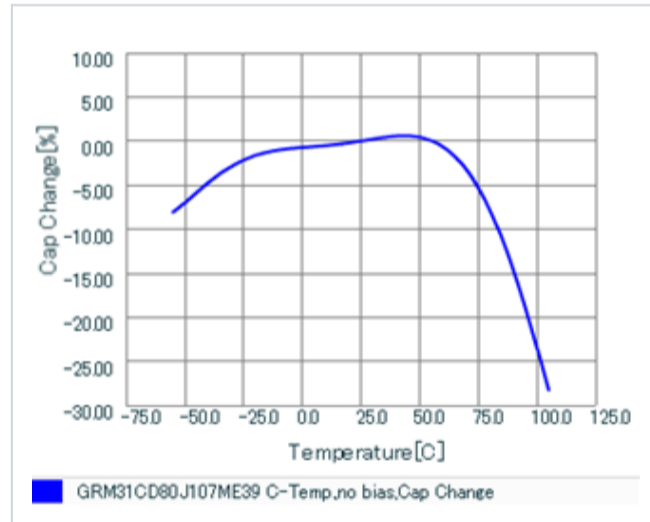

▪ Calorific property by ripple current

