

# CHIP COILS

# CHIP COILS

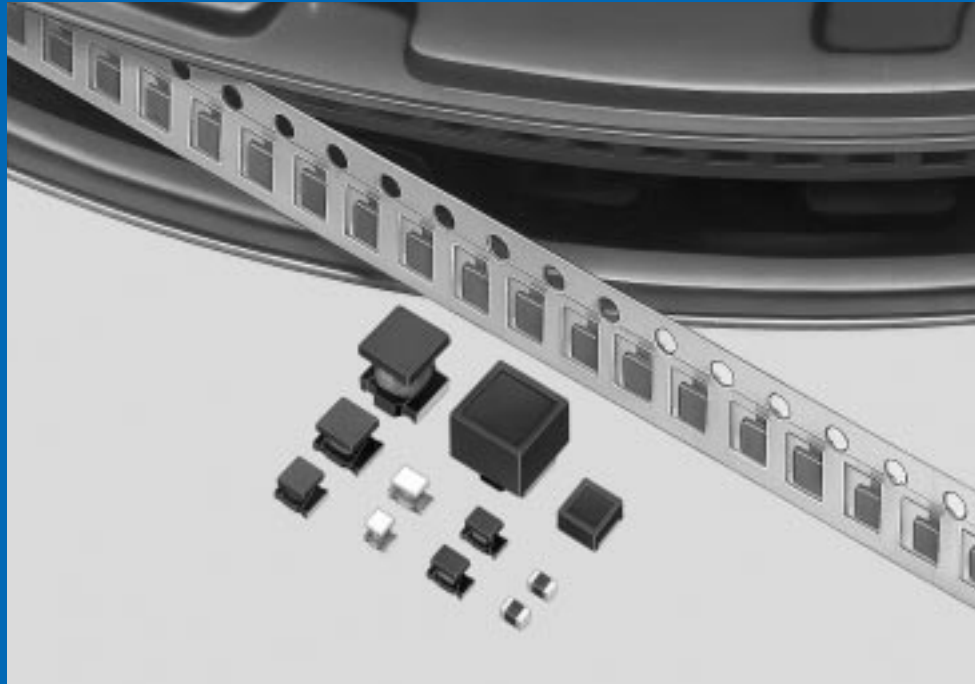

Murata  
Manufacturing Co., Ltd.

Cat.No.O05E-6

# CONTENTS

Part Numbering	2
Products Guide	3
Selection Guide	4
<b>1</b> High-frequency Monolithic Type LQG15H/LQG18H Series	5
<b>2</b> High-frequency Flim Type LQP03T/LQP15M Series	8
<b>3</b> High-frequency Winding Type LQW15A/LQW18A Series	11
<b>4</b> High-frequency Winding Type LQW2BH/LQW31H Series	15
<b>5</b> High-frequency Winding Type LQH31H Series	19
<b>6</b> for General Use Monolithic Type LQM18N/LQM21N Series	20
<b>7</b> for General Use Winding Type LQH31M/LQH32M/LQH43M(N) Series	23
<b>8</b> for General Use Magnetic Shielded Type LQH3ER Series	29
<b>9</b> for Choke Monolithic Type LQM21D/LQM21F/LQM31F Series	31
<b>10</b> for Choke Winding Type LQH31C/LQH32C/LQH43C Series	34
<b>11</b> for Choke Magnetic Shielded Type LQH3KS Series	38
<b>12</b> for Choke Winding/Magnetic Shielded Type LQH55D/LQH66S Series	39
Monolithic And Film Type Notice(Soldering and Mounting)	42
Winding Type Notice(Soldering and Mounting)	45
Winding And Mgnetic Shielded Type Notice(Soldering and Mounting)	49
Larege-current Type Notice(Soldering and Mounting)	52
Notice	54
Packaging	56
Design Kits	58
Information	63

● **Part Numbering** (The structure of the "Global Part Numbers" that will be adopted from June 2001 and the meaning of each code are described herein.)  
 (If you have any questions about details, inquire at your usual Murata sales office or distributor.)

**Chip Coils (SMD)**



① Product ID

Product ID	
<b>LQ</b>	Chip Coils

② Structure

Code	Structure
<b>G</b>	Monolithic Type (Air-core Coil)
<b>H</b>	Winding Type (Ferrite Core)
<b>M</b>	Monolithic (Ferriet Core)
<b>P</b>	Film Type
<b>W</b>	Winding Type (Air-core Coil)

③ Dimension (L×W)

Code	Dimension (L×W)
<b>03</b>	0.60×0.30mm
<b>15</b>	1.00×0.50mm
<b>18</b>	1.60×0.80mm
<b>21</b>	2.00×1.25mm
<b>2B</b>	2.00×1.50mm
<b>31</b>	3.20×1.60mm
<b>32</b>	3.20×2.50mm
<b>3E</b>	3.50×3.20mm
<b>3K</b>	3.30×3.30mm
<b>43</b>	4.50×3.20mm
<b>55</b>	5.70×5.00mm
<b>66</b>	6.30×6.30mm

④ Applications and Characteristics

Code	Series	Applications and Characteristics
<b>H</b>	<b>LQG</b>	Monolithic Air-core
<b>N</b>		for Resonant Circuit
<b>D</b>	<b>LQM</b>	for Choke (Low-current DC Power Supplies)
<b>F</b>		for Choke (DC Power Supplies)
<b>M</b>	<b>LQP</b>	Film Type
<b>T</b>		Film Type (Low DC Resistance Type)
<b>A</b>	<b>LQW</b>	High Q Type (UFH-SHF)
<b>H</b>		High Q Type (VHF-UHF)
<b>N</b>		for Resonant Circuit
<b>M</b>		for Resonant Circuit (Coating Type)
<b>R</b>	<b>LQH</b>	for Resonant Circuit (Magnetically Shielded Type)
<b>D</b>		for Choke
<b>C</b>		for Choke (Coating Type)
<b>S</b>		for Choke (Magnetically Shielded Type)
<b>H</b>		for High-frequency Resonant Circuit

⑤ Category

Code	Category
<b>N</b>	Standard Type

⑥ Inductance

Expressed by three figures. The unit is micro-henry (μH). The first and second figures are significant digits, and the third figure expresses the number of zero which follow the two figures. If there is a decimal point, it is expressed by capital letter "R". In this case, all figures are significant digits. If inductance is less than 0.1μH, the inductance code is expressed by combination of two figures are capital letter "N", and the unit of inductance is nano-henry (nH). Capital letter "N" indicates the unit of "nH", and also expresses a decimal point. In this case, all figure are significant digits.

⑦ Inductance Tolerance

Code	Inductance Tolerance
<b>B</b>	±0.1nH
<b>C</b>	±0.2nH
<b>D</b>	±0.5nH
<b>G</b>	±2%
<b>H</b>	±3%
<b>J</b>	±5%
<b>K</b>	±10%
<b>M</b>	±20%
<b>N</b>	±30%
<b>S</b>	±0.3nH

⑧ Features

Expressed by a figure from "0" to "2".

Ex.) 

Code	Features
<b>0</b>	Standard Type

⑨ Electrode

Code	Electrode
<b>0</b>	Solder Plating
<b>1</b>	Sputtering
<b>2</b>	Sn Plating

⑩ Packaging

Code	Pakaging
<b>K</b>	Plastic Taping (ø330mm Reel)
<b>L</b>	Plastic Taping (ø180mm Reel)
<b>B</b>	Bulk
<b>J</b>	Paper Taping (ø330mm Reel)
<b>D</b>	Paper Taping (ø180mm Reel)

## Products Guide

Murata's LQ□ series of chip coils consists of compact, high-performance inductors. Their innovative coil and case structures mean low DC resistance and outstanding

high-frequency characteristics. The series is designed for a variety of applications, facilitating component selection for individual circuit requirements.

Application	Part Number	Structure	Dimensions		Inductance Range (H)								Page	
			(mm)	(inch)	1n	10n	100n	1μ	10μ	100μ	1m	10m		
for High-frequency	LQG15H	Monolithic Type	1.0 ■0.5	0402									5-7	
	LQG18H		1.6 ■0.8	0603										
	Tight inductance tolerance	LQP03T	Film Type	0.6 ■0.3	0201									8-10
		LQP15M		1.0 ■0.5	0402									
		LQW15A	Winding Type (air core)	1.0 ■0.5	0402									11-14
		LQW18A		1.6 ■0.8	0603									
		LQW2BH		2.0 ■1.5	0805									15-18
		LQW31H		3.2 ■1.6	1206									
		LQH31H		3.2 ■1.6	1206									
for General Use	LQH31M	Winding Type (ferrite core)	3.2 ■1.6	1206									23-28	
	LQH32M		3.2 ■2.5	1210										
	LQH43M(N)		4.5 ■3.2	1812										
		LQM18N	Magnetically shielded monolithic Type	1.6 ■0.8	0603									20-22
		LQM21N		2.0 ■1.25	0805									
Tight inductance tolerance	LQH3ER	Magnetically shielded Type	3.2 ■3.5	1214									29-30	
for Choke	LQH31C	Winding Type	3.2 ■1.6	1206									34-37	
	LQH32CN_51		3.2 ■2.5	1210										
	LQH32C		3.2 ■2.5	1210										
	LQH43C		4.5 ■3.2	1812										
		LQM21D	Magnetically shielded monolithic Type	2.0 ■1.25	0805									31-33
		LQM21F		2.0 ■1.25	0805									
		LQM31F		3.2 ■1.6	1206									
	LQH55D	Winding Type	5.7 ■5.0	2220									39-40	
	LQH3KS	Magnetically shielded Type	3.3 ■3.3	1212									38	
	LQH66S		6.3 ■6.3	2525									40-41	

## Selection Guide

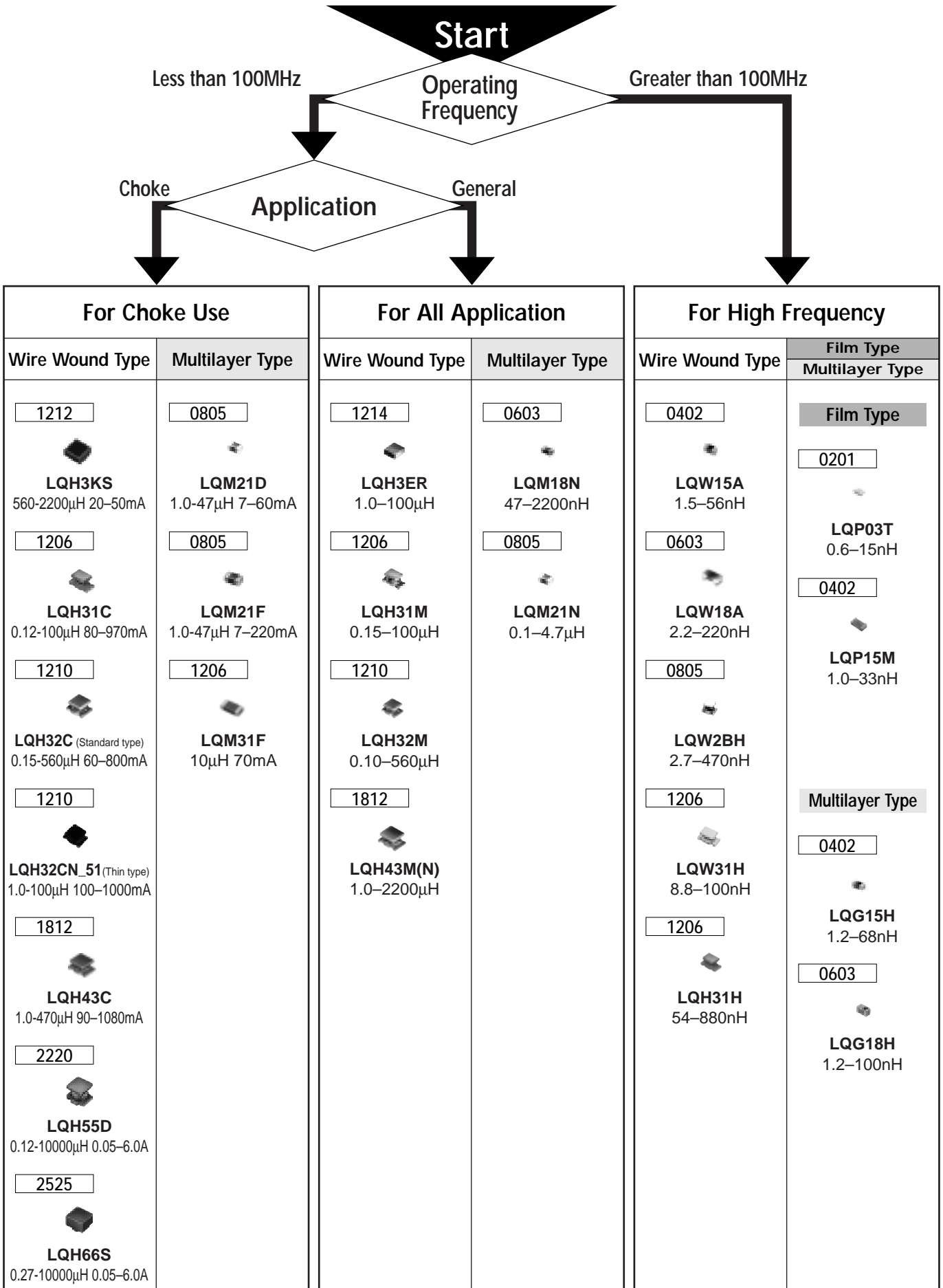

# CHIP COILS



## High-frequency Monolithic Type LQG15H/LQG18H Series

### LQG15H Series

The LQG15H series are chip inductors specifically, designed for high frequency applications. The LQG15H series is designed to realize stable characteristics in high frequency range applying integrated multilayer process. The integrated multilayer process enables a wide range of inductance values with tight tolerance.

#### ■ Features

1. High-Q, stable inductance in high frequency is achieved by the unique low-capacitance structure. It is suitable for mobile communication equipment.
2. The small size of LQG15H (1.0x0.5x0.5mm) is ideal for small mobile equipment.
3. The external electrodes with nickel barrier structure provide excellent solder heat resistance.

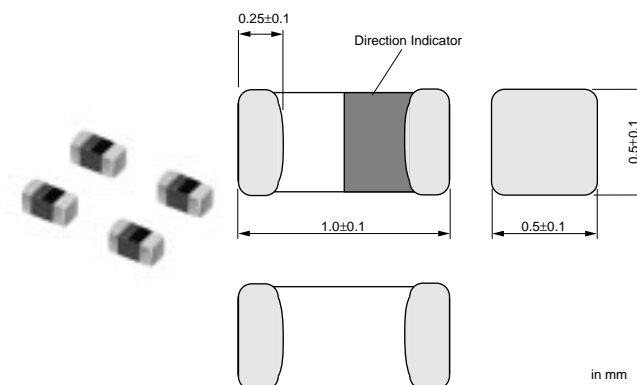

Part Number	Inductance (nH)	Rated Current (mA)	Max. of DC resistance (ohm)	Q (min.)	Self Resonance Frequency (MHz)
LQG15HN6N8J00	6.8 ±5%	200	0.29 max	8 at 100MHz	4200 min.
LQG15HN8N2J00	8.2 ±5%	200	0.33 max	8 at 100MHz	3600 min.
LQG15HN10NJ00	10 ±5%	200	0.35 max	8 at 100MHz	3200 min.
LQG15HN12NJ00	12 ±5%	200	0.41 max	8 at 100MHz	2800 min.
LQG15HN15NJ00	15 ±5%	200	0.46 max	8 at 100MHz	2300 min.
LQG15HN18NJ00	18 ±5%	200	0.51 max	8 at 100MHz	2100 min.
LQG15HN22NJ00	22 ±5%	200	0.58 max	8 at 100MHz	1800 min.
LQG15HN27NJ00	27 ±5%	200	0.67 max	8 at 100MHz	1600 min.
LQG15HN33NJ00	33 ±5%	200	0.67 max	8 at 100MHz	1500 min.
LQG15HN39NJ00	39 ±5%	150	1.06 max	8 at 100MHz	1200 min.
LQG15HN47NJ00	47 ±5%	150	1.15 max	8 at 100MHz	1000 min.
LQG15HN56NJ00	56 ±5%	150	1.20 max	8 at 100MHz	800 min.
LQG15HN68NJ00	68 ±5%	150	1.25 max	8 at 100MHz	800 min.
LQG15HN1N2S00	1.2 ±0.3nH	200	0.10 max	8 at 100MHz	6000 min.
LQG15HN1N5S00	1.5 ±0.3nH	200	0.10 max	8 at 100MHz	6000 min.
LQG15HN1N8S00	1.8 ±0.3nH	200	0.10 max	8 at 100MHz	6000 min.
LQG15HN2N2S00	2.2 ±0.3nH	200	0.15 max	8 at 100MHz	6000 min.
LQG15HN2N7S00	2.7 ±0.3nH	200	0.17 max	8 at 100MHz	6000 min.
LQG15HN3N3S00	3.3 ±0.3nH	200	0.19 max	8 at 100MHz	6000 min.
LQG15HN3N9S00	3.9 ±0.3nH	200	0.19 max	8 at 100MHz	6000 min.
LQG15HN4N7S00	4.7 ±0.3nH	200	0.23 max	8 at 100MHz	6000 min.
LQG15HN5N6S00	5.6 ±0.3nH	200	0.26 max	8 at 100MHz	5300 min.

Min. of Operating Temp. : -40°C to 85°C

# 1 ■ Q-Frequency Characteristics

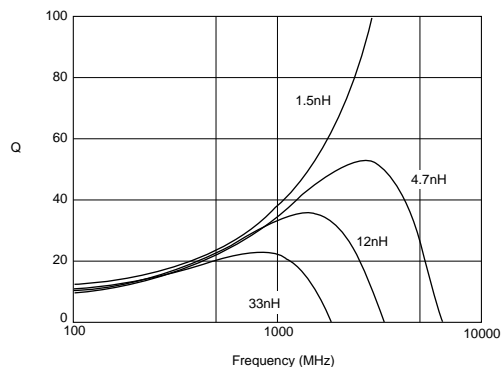

# ■ Inductance-Frequency Characteristics

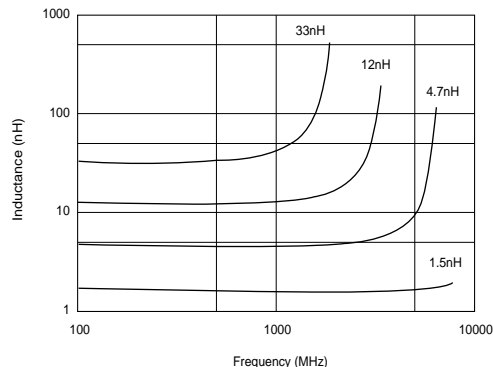

## LQG18H Series

The LQG18H series is designed to realize stable characteristics in high frequency range applying intergrated multilayer process.

### ■ Features

1. High-Q, stable inductance in high frequency is available due to its original low-capacitance structure. It is suitable for small handy equipment, especially for card size equipment.
2. Small size of LQG18H (1.6x0.8x0.8mm) is suitable for small handy equipment, especially for card size equipment.
3. The external electrodes with nickel barrier structure provide excellent solder heat resistance.

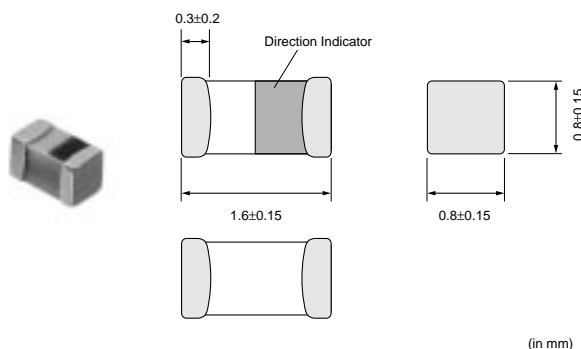

Part Number	Inductance (nH)	Rated Current (mA)	Max. of DC resistance (ohm)	Q (min.)	Self Resonance Frequency (MHz)
LQG18HN6N8J00	6.8 ±5%	300	0.25 max	12 at 100MHz	5000 min.
LQG18HN8N2J00	8.2 ±5%	300	0.25 max	12 at 100MHz	4000 min.
LQG18HN10NJ00	10 ±5%	300	0.30 max	12 at 100MHz	3500 min.
LQG18HN12NJ00	12 ±5%	300	0.35 max	12 at 100MHz	3000 min.
LQG18HN15NJ00	15 ±5%	300	0.40 max	12 at 100MHz	2800 min.
LQG18HN18NJ00	18 ±5%	300	0.45 max	12 at 100MHz	2600 min.
LQG18HN22NJ00	22 ±5%	300	0.50 max	12 at 100MHz	2300 min.
LQG18HN27NJ00	27 ±5%	300	0.55 max	12 at 100MHz	2000 min.
LQG18HN33NJ00	33 ±5%	300	0.60 max	12 at 100MHz	1700 min.
LQG18HN39NJ00	39 ±5%	300	0.65 max	12 at 100MHz	1500 min.
LQG18HN47NJ00	47 ±5%	300	0.70 max	12 at 100MHz	1200 min.
LQG18HN56NJ00	56 ±5%	300	0.75 max	12 at 100MHz	1100 min.
LQG18HN68NJ00	68 ±5%	300	0.80 max	12 at 100MHz	1000 min.
LQG18HN82NJ00	82 ±5%	300	0.85 max	12 at 100MHz	900 min.
LQG18HNR10J00	100 ±5%	300	0.90 max	12 at 100MHz	800 min.
LQG18HN1N2S00	1.2 ±0.3nH	300	0.1 max	12 at 100MHz	6000 min.
LQG18HN1N5S00	1.5 ±0.3nH	300	0.1 max	12 at 100MHz	6000 min.
LQG18HN1N8S00	1.8 ±0.3nH	300	0.1 max	12 at 100MHz	6000 min.
LQG18HN2N2S00	2.2 ±0.3nH	300	0.1 max	12 at 100MHz	6000 min.
LQG18HN2N7S00	2.7 ±0.3nH	300	0.15 max	12 at 100MHz	6000 min.
LQG18HN3N3S00	3.3 ±0.3nH	300	0.15 max	12 at 100MHz	6000 min.
LQG18HN3N9S00	3.9 ±0.3nH	300	0.15 max	12 at 100MHz	6000 min.
LQG18HN4N7S00	4.7 ±0.3nH	300	0.20 max	12 at 100MHz	6000 min.
LQG18HN5N6S00	5.6 ±0.3nH	300	0.20 max	12 at 100MHz	5000 min.

Min. of Operating Temp. : -40°C to +85°C

### ■ Q-Frequency Characteristics

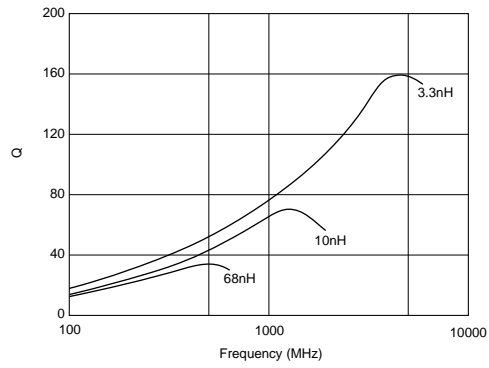

### ■ Inductance-Frequency Characteristics

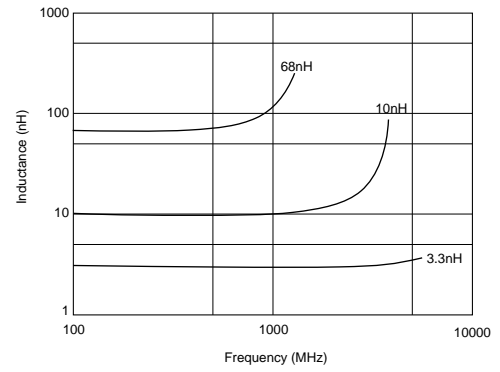

# CHIP COILS



2

## High-frequency Flim Type LQP03T/LQP15M Series

### LQP03T Series

The LQP03T series consists of Ultra-Small chip coils with High Q value using Murata's original film technology.

#### ■ Features

1. Ultra small size 0.6mmx0.3mm
2. Ultra-thin size
3. High Q value in high frequency band.
4. Lead is not contained in the products.

#### ■ Applications

High frequency circuits of telecommunication equipments such as PDC, PCS, GSM and CDMA.

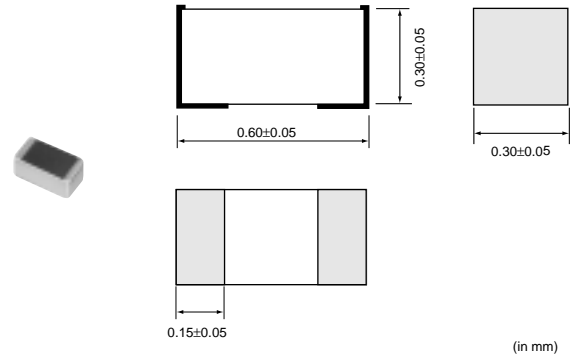

Part Number	Inductance (nH)	Rated Current (mA)	Max. of DC resistance (ohm)	Q (min.)	Self Resonance Frequency (MHz)
LQP03TN0N6C00	0.6 ±0.2nH	420	0.08	11 at 500MHz	6000 min.
LQP03TN0N8C00	0.8 ±0.2nH	410	0.09	11 at 500MHz	6000 min.
LQP03TN1N0C00	1.0 ±0.2nH	400	0.10	11 at 500MHz	6000 min.
LQP03TN1N2C00	1.2 ±0.2nH	280	0.13	11 at 500MHz	6000 min.
LQP03TN1N5C00	1.5 ±0.2nH	280	0.16	11 at 500MHz	6000 min.
LQP03TN1N8C00	1.8 ±0.2nH	280	0.16	11 at 500MHz	6000 min.
LQP03TN2N2C00	2.2 ±0.2nH	220	0.18	11 at 500MHz	6000 min.
LQP03TN2N7C00	2.7 ±0.2nH	220	0.21	11 at 500MHz	6000 min.
LQP03TN3N3C00	3.3 ±0.2nH	190	0.30	11 at 500MHz	6000 min.
LQP03TN3N9C00	3.9 ±0.2nH	170	0.45	11 at 500MHz	6000 min.
LQP03TN4N7J00	4.7 ±5%	160	0.55	11 at 500MHz	6000 min.
LQP03TN5N6J00	5.6 ±5%	140	0.68	11 at 500MHz	6000 min.
LQP03TN6N8J00	6.8 ±5%	130	0.75	11 at 500MHz	6000 min.
LQP03TN8N2J00	8.2 ±5%	110	0.86	11 at 500MHz	5500 min.
LQP03TN10NJ00	10 ±5%	100	1.10	11 at 500MHz	4500 min.
LQP03TN12NJ00	12 ±5%	90	1.25	11 at 500MHz	3700 min.
LQP03TN15NJ00	15 ±5%	90	1.50	11 at 500MHz	3300 min.

Min. of Operating Temp. : -40°C to +85°C

#### ■ Q-Frequency Characteristics

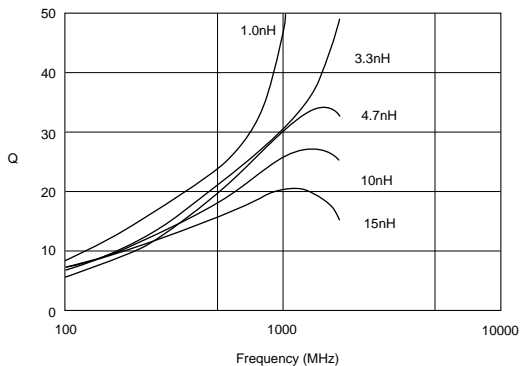

#### ■ Inductance-Frequency Characteristics

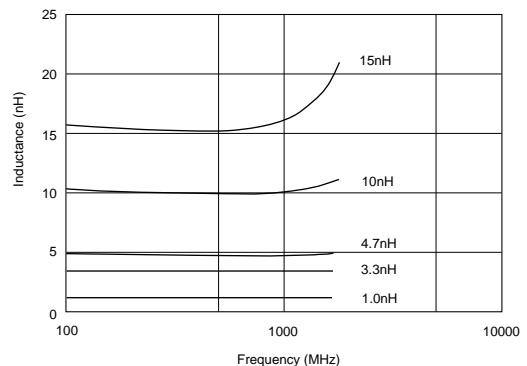

## LQP15M Series

### ■ Features

1. Tight inductance tolerance (+-0.1nH, +-2%) realized by Murata's original film technology. Various inductance values enable to assemble with no tuning.
2. Ultra small size 0402 inductor which is low profile and lightest weight in the world enables to miniaturize mobile telecommunication equipment.  
Weight : LQP15M series 0.61mg/pcs <-- --> Multilayer Type  
Inductor 0.94mg/pcs.
3. High Q at high frequency range.
4. High self resonant frequency due to low stray capacitance and close inductance distribution provide stable inductance in high frequency circuit such as telecommunication equipment.

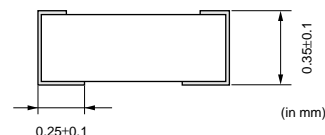
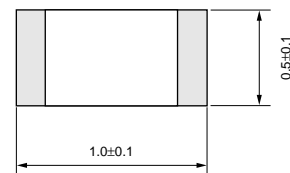

### ■ Applications

- High frequency circuit of telecommunication equipment, such as DECT, PHS, PCS, PCN, GSM, DCS and CDMA.
- Impedance Matching -- Power-AMP Module(PA)
- SAW filter Resonance circuits -- VCO

Part Number	Inductance (nH)	Rated Current (mA)	Max. of DC resistance (ohm)	Q (min.)	Self Resonance Frequency (MHz)
LQP15MN1N0B00	1.0 ±0.1nH	400	0.1	13 at 500MHz	6000 min.
LQP15MN1N1B00	1.1 ±0.1nH	390	0.1	13 at 500MHz	6000 min.
LQP15MN1N2B00	1.2 ±0.1nH	390	0.1	13 at 500MHz	6000 min.
LQP15MN1N3B00	1.3 ±0.1nH	280	0.2	13 at 500MHz	6000 min.
LQP15MN1N5B00	1.5 ±0.1nH	280	0.2	13 at 500MHz	6000 min.
LQP15MN1N6B00	1.6 ±0.1nH	220	0.3	13 at 500MHz	6000 min.
LQP15MN1N8B00	1.8 ±0.1nH	280	0.2	13 at 500MHz	6000 min.
LQP15MN2N0B00	2.0 ±0.1nH	220	0.3	13 at 500MHz	6000 min.
LQP15MN2N2B00	2.2 ±0.1nH	220	0.3	13 at 500MHz	6000 min.
LQP15MN2N4B00	2.4 ±0.1nH	220	0.3	13 at 500MHz	6000 min.
LQP15MN2N7B00	2.7 ±0.1nH	220	0.3	13 at 500MHz	6000 min.
LQP15MN3N0B00	3.0 ±0.1nH	190	0.4	13 at 500MHz	6000 min.
LQP15MN3N3B00	3.3 ±0.1nH	190	0.4	13 at 500MHz	6000 min.
LQP15MN3N6B00	3.6 ±0.1nH	170	0.5	13 at 500MHz	6000 min.
LQP15MN3N9B00	3.9 ±0.1nH	170	0.5	13 at 500MHz	6000 min.
LQP15MN4N3B00	4.3 ±0.1nH	160	0.6	13 at 500MHz	6000 min.
LQP15MN4N7B00	4.7 ±0.1nH	160	0.6	13 at 500MHz	6000 min.
LQP15MN5N1B00	5.1 ±0.1nH	140	0.7	13 at 500MHz	6000 min.
LQP15MN5N6B00	5.6 ±0.1nH	140	0.7	13 at 500MHz	6000 min.
LQP15MN6N2B00	6.2 ±0.1nH	130	0.9	13 at 500MHz	6000 min.
LQP15MN6N8B00	6.8 ±0.1nH	130	0.9	13 at 500MHz	6000 min.
LQP15MN7N5B00	7.5 ±0.1nH	110	1.1	13 at 500MHz	5500 min.
LQP15MN8N2B00	8.2 ±0.1nH	110	1.1	13 at 500MHz	5500 min.
LQP15MN9N1B00	9.1 ±0.1nH	100	1.3	13 at 500MHz	4500 min.
LQP15MN1N0C00	1.0 ±0.2nH	400	0.1	13 at 500MHz	6000 min.
LQP15MN1N1C00	1.1 ±0.2nH	390	0.1	13 at 500MHz	6000 min.
LQP15MN1N2C00	1.2 ±0.2nH	390	0.1	13 at 500MHz	6000 min.
LQP15MN1N3C00	1.3 ±0.2nH	280	0.2	13 at 500MHz	6000 min.
LQP15MN1N5C00	1.5 ±0.2nH	280	0.2	13 at 500MHz	6000 min.
LQP15MN1N6C00	1.6 ±0.2nH	220	0.3	13 at 500MHz	6000 min.
LQP15MN1N8C00	1.8 ±0.2nH	280	0.2	13 at 500MHz	6000 min.
LQP15MN2N0C00	2.0 ±0.2nH	220	0.3	13 at 500MHz	6000 min.

Continued on the following page.

Continued from the preceding page.

2

Part Number	Inductance (nH)	Rated Current (mA)	Max. of DC resistance (ohm)	Q (min.)	Self Resonance Frequency (MHz)
LQP15MN2N2C00	2.2 ±0.2nH	220	0.3	13 at 500MHz	6000 min.
LQP15MN2N4C00	2.4 ±0.2nH	220	0.3	13 at 500MHz	6000 min.
LQP15MN2N7C00	2.7 ±0.2nH	220	0.3	13 at 500MHz	6000 min.
LQP15MN3N0C00	3.0 ±0.2nH	190	0.4	13 at 500MHz	6000 min.
LQP15MN3N3C00	3.3 ±0.2nH	190	0.4	13 at 500MHz	6000 min.
LQP15MN3N6C00	3.6 ±0.2nH	170	0.5	13 at 500MHz	6000 min.
LQP15MN3N9C00	3.9 ±0.2nH	170	0.5	13 at 500MHz	6000 min.
LQP15MN4N3C00	4.3 ±0.2nH	160	0.6	13 at 500MHz	6000 min.
LQP15MN4N7C00	4.7 ±0.2nH	160	0.6	13 at 500MHz	6000 min.
LQP15MN5N1C00	5.1 ±0.2nH	140	0.7	13 at 500MHz	6000 min.
LQP15MN5N6C00	5.6 ±0.2nH	140	0.7	13 at 500MHz	6000 min.
LQP15MN6N2C00	6.2 ±0.2nH	130	0.9	13 at 500MHz	6000 min.
LQP15MN6N8C00	6.8 ±0.2nH	130	0.9	13 at 500MHz	6000 min.
LQP15MN7N5C00	7.5 ±0.2nH	110	1.1	13 at 500MHz	5500 min.
LQP15MN8N2C00	8.2 ±0.2nH	110	1.1	13 at 500MHz	5500 min.
LQP15MN9N1C00	9.1 ±0.2nH	100	1.3	13 at 500MHz	4500 min.
LQP15MN10NG00	10 ±2%	100	1.3	13 at 500MHz	4500 min.
LQP15MN12NG00	12 ±0.2nH	90	1.6	13 at 500MHz	3700 min.
LQP15MN15NG00	15 ±0.2nH	90	1.8	13 at 500MHz	3300 min.
LQP15MN18NG00	18 ±0.2nH	80	2.0	13 at 500MHz	3100 min.
LQP15MN22NG00	22 ±0.2nH	70	2.6	13 at 500MHz	2800 min.
LQP15MN27NG00	27 ±0.2nH	70	3.1	13 at 500MHz	2500 min.
LQP15MN33NG00	33 ±0.2nH	60	3.8	13 at 500MHz	2100 min.

Min. of Operating Temp.: -40°C to +85°C

### ■ Q-Frequency Characteristics

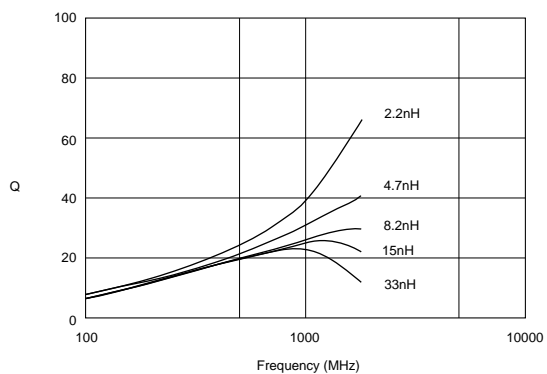

### ■ Inductance-Frequency Characteristics

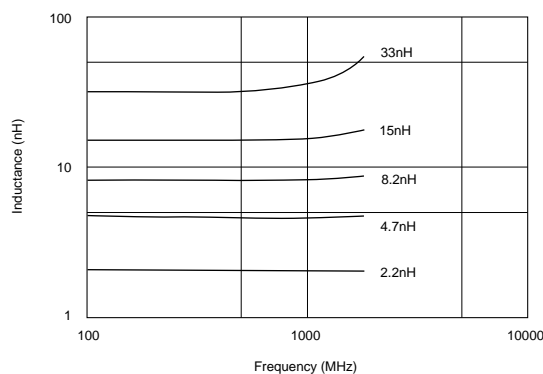

# CHIP COILS



## High-frequency Winding Type LQW15A/LQW18A Series

### LQW15A Series

The LQW15A series which consists of air core chip coil using a miniature alumina core.

The tight inductance tolerance (+-0.2nH,+-3%) is available due to Murata's original winding technology.

The LQW15A series has high Q value and high self resonant frequency in high frequency range. It is suitable for high frequency circuits which are used in telecommunication equipment.

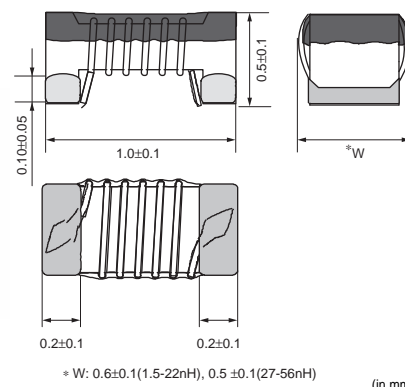

#### ■ Features

1. Horizontal winding structure enables tight inductance tolerance(+0.2nH,+3%)
2. The subminiature dimensions (1.0x0.5mm) allow high density mounting.
3. The high self resonant frequency realizes high-Q value and stable inductance at high frequency.
4. Low DC resistance design is ideal for low loss,high output and low power consumption.
5. Resin-coated surface enables excellent mounting.

#### ■ Applications

- High frequency circuits in telecommunication equipment, such as DECT,PHS,PCS,PCN,GSM and CDMA.
- Impedance Matching -- Power-AMP Module (PA)
- SAW filter Resonance circuits -- VCO

Part Number	Inductance (nH)	Rated Current (mA)	Max. of DC resistance (ohm)	Q (min.)	Self Resonance Frequency (GHz)
LQW15AN1N5C00	1.5 ±0.2nH	1000	0.03	10 at 250MHz	18.0 min.
LQW15AN2N7C00	2.7 ±0.2nH	850	0.05	20 at 250MHz	15.0 min.
LQW15AN4N3C00	4.3 ±0.2nH	750	0.07	25 at 250MHz	10.0 min.
LQW15AN4N7C00	4.7 ±0.2nH	750	0.07	25 at 250MHz	8.0 min.
LQW15AN5N1C00	5.1 ±0.2nH	600	0.12	25 at 250MHz	8.0 min.
LQW15AN6N2C00	6.2 ±0.2nH	700	0.09	25 at 250MHz	8.0 min.
LQW15AN1N5D00	1.5 ±0.5nH	1000	0.03	10 at 250MHz	18.0 min.
LQW15AN2N7D00	2.7 ±0.5nH	850	0.05	20 at 250MHz	15.0 min.
LQW15AN4N3D00	4.3 ±0.5nH	750	0.07	25 at 250MHz	10.0 min.
LQW15AN4N7D00	4.7 ±0.5nH	750	0.07	25 at 250MHz	8.0 min.
LQW15AN5N1D00	5.1 ±0.5nH	600	0.12	25 at 250MHz	8.0 min.
LQW15AN6N2D00	6.2 ±0.5nH	700	0.09	25 at 250MHz	8.0 min.
LQW15AN6N8H00	6.8 ±3%	700	0.09	25 at 250MHz	6.0 min.
LQW15AN7N5H00	7.5 ±3%	570	0.13	25 at 250MHz	6.0 min.
LQW15AN9N1H00	9.1 ±3%	540	0.14	25 at 250MHz	5.5 min.
LQW15AN10NH00	10 ±3%	500	0.17	25 at 250MHz	5.5 min.
LQW15AN12NH00	12 ±3%	500	0.14	30 at 250MHz	5.5 min.
LQW15AN15NH00	15 ±3%	460	0.16	30 at 250MHz	5.0 min.
LQW15AN18NH00	18 ±3%	370	0.27	25 at 250MHz	4.5 min.
LQW15AN22NH00	22 ±3%	310	0.30	25 at 250MHz	4.0 min.
LQW15AN27NH00	27 ±3%	280	0.52	25 at 250MHz	3.5 min.
LQW15AN33NH00	33 ±3%	260	0.63	25 at 250MHz	3.2 min.

Continued on the following page.

3

Continued from the preceding page.

Part Number	Inductance (nH)	Rated Current (mA)	Max. of DC resistance (ohm)	Q (min.)	Self Resonance Frequency (GHz)
LQW15AN39NH00	39 ±3%	250	0.70	25 at 250MHz	3.0 min.
LQW15AN47NH00	47 ±3%	210	1.08	25 at 200MHz	2.9 min.
LQW15AN56NH00	56 ±3%	200	1.17	25 at 200MHz	2.8 min.
LQW15AN6N8J00	6.8 ±5%	700	0.09	25 at 250MHz	6.0 min.
LQW15AN7N5J00	7.5 ±5%	570	0.13	25 at 250MHz	6.0 min.
LQW15AN9N1J00	9.1 ±5%	540	0.14	25 at 250MHz	5.5 min.
LQW15AN10NJ00	10 ±5%	500	0.17	25 at 250MHz	5.5 min.
LQW15AN12NJ00	12 ±5%	500	0.14	30 at 250MHz	5.5 min.
LQW15AN15NJ00	15 ±5%	460	0.16	30 at 250MHz	5.0 min.
LQW15AN18NJ00	18 ±5%	370	0.27	25 at 250MHz	4.5 min.
LQW15AN22NJ00	22 ±5%	310	0.30	25 at 250MHz	4.0 min.
LQW15AN27NJ00	27 ±5%	280	0.52	25 at 250MHz	3.5 min.
LQW15AN33NJ00	33 ±5%	260	0.63	25 at 250MHz	3.2 min.
LQW15AN39NJ00	39 ±5%	250	0.70	25 at 250MHz	3.0 min.
LQW15AN47NJ00	47 ±5%	210	1.08	25 at 200MHz	2.9 min.
LQW15AN56NJ00	56 ±5%	200	1.17	25 at 200MHz	2.8 min.

Min. of Operating Temp. : -50°C to 125°C

■ Q-Frequency Characteristics

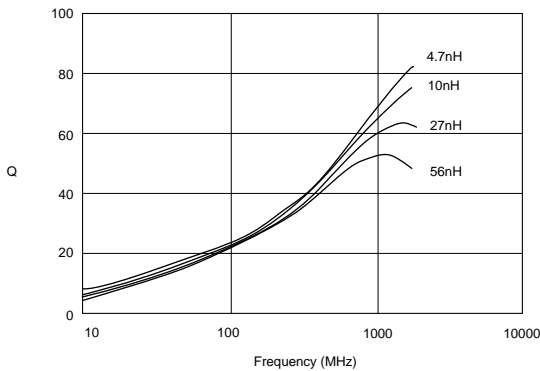

■ Inductance-Frequency Characteristics

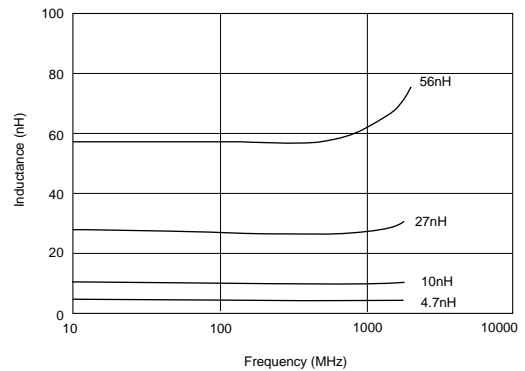

**LQW18A Series**

■ Features

1. Broad range of inductance(3.6nH to 220nH) with E24 step line up.
2. Horizontal winding structure enables tight inductance (+-0.2nH, +-2%). Stable circuit operation is possible.
3. The subminiature dimensions (1.6x0.8mm) allow high density mounting.
4. The high self resonant frequency realizes high-Q value and stable inductance at high frequency.
5. Low DC resistance design is ideal for low loss, high output and low power consumption.
6. Resin-coated surface enables excellent mounting.

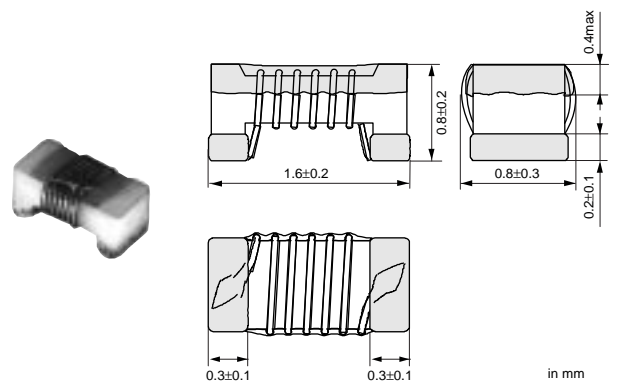

■ Applications

- High frequency circuit in telecommunication equipment, such as DECT, PHS, PCS, GSM and CDMA.
- Impedance Matching -- Power-AMP Module(PA)
- SAW filter Resonance circuits -- VCO

Part Number	Inductance (nH)	Rated Current (mA)	Max. of DC resistance (ohm)	Q (min.)	Self Resonance Frequency (MHz)
LQW18AN3N6C00	3.6 ±0.2nH	850	0.059	25 at 250MHz	6000 min.
LQW18AN3N9C00	3.9 ±0.2nH	850	0.059	35 at 250MHz	6000 min.
LQW18AN4N3C00	4.3 ±0.2nH	850	0.059	35 at 250MHz	6000 min.
LQW18AN5N6C00	5.6 ±0.2nH	750	0.082	35 at 250MHz	6000 min.
LQW18AN6N2C00	6.2 ±0.2nH	750	0.082	35 at 250MHz	6000 min.
LQW18AN6N8C00	6.8 ±0.2nH	750	0.082	35 at 250MHz	6000 min.
LQW18AN2N2D00	2.2 ±0.5nH	700	0.049	16 at 250MHz	6000 min.
LQW18AN3N6D00	3.6 ±0.5nH	850	0.059	25 at 250MHz	6000 min.
LQW18AN3N9D00	3.9 ±0.5nH	850	0.059	35 at 250MHz	6000 min.
LQW18AN4N3D00	4.3 ±0.5nH	850	0.059	35 at 250MHz	6000 min.
LQW18AN4N7D00	4.7 ±0.5nH	850	0.059	35 at 250MHz	6000 min.
LQW18AN5N6D00	5.6 ±0.5nH	750	0.082	35 at 250MHz	6000 min.
LQW18AN6N2D00	6.2 ±0.5nH	750	0.082	35 at 250MHz	6000 min.
LQW18AN6N8D00	6.8 ±0.5nH	750	0.082	35 at 250MHz	6000 min.
LQW18AN7N5D00	7.5 ±0.5nH	750	0.082	35 at 250MHz	6000 min.
LQW18AN8N2D00	8.2 ±0.5nH	650	0.11	35 at 250MHz	6000 min.
LQW18AN8N7D00	8.7 ±0.5nH	650	0.11	35 at 250MHz	6000 min.
LQW18AN9N1D00	9.1 ±0.5nH	650	0.11	35 at 250MHz	6000 min.
LQW18AN9N5D00	9.5 ±0.5nH	650	0.11	35 at 250MHz	6000 min.
LQW18AN10NG00	10 ±2%	650	0.11	35 at 250MHz	6000 min.
LQW18AN11NG00	11 ±2%	650	0.11	35 at 250MHz	6000 min.
LQW18AN12NG00	12 ±2%	600	0.13	35 at 250MHz	6000 min.
LQW18AN13NG00	13 ±2%	600	0.13	35 at 250MHz	6000 min.
LQW18AN15NG00	15 ±2%	600	0.13	40 at 250MHz	6000 min.
LQW18AN16NG00	16 ±2%	550	0.16	40 at 250MHz	5500 min.
LQW18AN18NG00	18 ±2%	550	0.16	40 at 250MHz	5500 min.
LQW18AN20NG00	20 ±2%	550	0.16	40 at 250MHz	4900 min.
LQW18AN22NG00	22 ±2%	500	0.17	40 at 250MHz	4600 min.
LQW18AN24NG00	24 ±2%	500	0.21	40 at 250MHz	3800 min.
LQW18AN27NG00	27 ±2%	440	0.21	40 at 250MHz	3700 min.
LQW18AN30NG00	30 ±2%	420	0.23	40 at 250MHz	3300 min.
LQW18AN33NG00	33 ±2%	420	0.23	40 at 250MHz	3200 min.
LQW18AN36NG00	36 ±2%	400	0.26	40 at 250MHz	2900 min.
LQW18AN39NG00	39 ±2%	400	0.26	40 at 250MHz	2800 min.
LQW18AN43NG00	43 ±2%	380	0.29	40 at 200MHz	2700 min.
LQW18AN47NG00	47 ±2%	380	0.29	38 at 200MHz	2600 min.
LQW18AN51NG00	51 ±2%	370	0.33	38 at 200MHz	2500 min.
LQW18AN56NG00	56 ±2%	360	0.35	38 at 200MHz	2400 min.
LQW18AN62NG00	62 ±2%	280	0.51	38 at 200MHz	2300 min.
LQW18AN68NG00	68 ±2%	340	0.38	38 at 200MHz	2200 min.
LQW18AN72NG00	72 ±2%	270	0.56	34 at 150MHz	2100 min.
LQW18AN75NG00	75 ±2%	270	0.56	34 at 150MHz	2050 min.
LQW18AN82NG00	82 ±2%	250	0.60	34 at 150MHz	2000 min.
LQW18AN91NG00	91 ±2%	230	0.64	34 at 150MHz	1900 min.
LQW18ANR10G00	100 ±2%	220	0.68	34 at 150MHz	1800 min.
LQW18ANR11G00	110 ±2%	220	1.2	32 at 150MHz	1350 min.
LQW18ANR12G00	120 ±2%	180	1.3	32 at 150MHz	1600 min.
LQW18ANR13G00	130 ±2%	170	1.4	32 at 150MHz	1450 min.
LQW18ANR15G00	150 ±2%	160	1.5	32 at 150MHz	1400 min.
LQW18ANR16G00	160 ±2%	150	2.1	32 at 150MHz	1350 min.
LQW18ANR18G00	180 ±2%	140	2.2	25 at 100MHz	1300 min.
LQW18ANR20G00	200 ±2%	120	2.4	25 at 100MHz	1250 min.
LQW18ANR22G00	220 ±2%	120	2.5	25 at 100MHz	1200 min.
LQW18AN10NJ00	10 ±5%	650	0.11	35 at 250MHz	6000 min.
LQW18AN11NJ00	11 ±5%	650	0.11	35 at 250MHz	6000 min.
LQW18AN12NJ00	12 ±5%	600	0.13	35 at 250MHz	6000 min.
LQW18AN13NJ00	13 ±5%	600	0.13	35 at 250MHz	6000 min.

Continued from the preceding page.

3

Part Number	Inductance (nH)	Rated Current (mA)	Max. of DC resistance (ohm)	Q (min.)	Self Resonance Frequency (MHz)
LQW18AN15NJ00	15 ±5%	600	0.13	40 at 250MHz	6000 min.
LQW18AN16NJ00	16 ±5%	550	0.16	40 at 250MHz	5500 min.
LQW18AN18NJ00	18 ±5%	550	0.16	40 at 250MHz	5500 min.
LQW18AN20NJ00	20 ±5%	550	0.16	40 at 250MHz	4900 min.
LQW18AN22NJ00	22 ±5%	500	0.17	40 at 250MHz	4600 min.
LQW18AN24NJ00	24 ±5%	500	0.21	40 at 250MHz	3800 min.
LQW18AN27NJ00	27 ±5%	440	0.21	40 at 250MHz	3700 min.
LQW18AN30NJ00	30 ±5%	420	0.23	40 at 250MHz	3300 min.
LQW18AN33NJ00	33 ±5%	420	0.23	40 at 250MHz	3200 min.
LQW18AN36NJ00	36 ±5%	400	0.26	40 at 250MHz	2900 min.
LQW18AN39NJ00	39 ±5%	400	0.26	40 at 250MHz	2800 min.
LQW18AN43NJ00	43 ±5%	380	0.29	40 at 200MHz	2700 min.
LQW18AN47NJ00	47 ±5%	380	0.29	38 at 200MHz	2600 min.
LQW18AN51NJ00	51 ±5%	370	0.33	38 at 200MHz	2500 min.
LQW18AN56NJ00	56 ±5%	360	0.35	38 at 200MHz	2400 min.
LQW18AN62NJ00	62 ±5%	280	0.51	38 at 200MHz	2300 min.
LQW18AN68NJ00	68 ±5%	340	0.38	38 at 200MHz	2200 min.
LQW18AN72NJ00	72 ±5%	270	0.56	34 at 150MHz	2100 min.
LQW18AN75NJ00	75 ±5%	270	0.56	34 at 150MHz	2050 min.
LQW18AN82NJ00	82 ±5%	250	0.60	34 at 150MHz	2000 min.
LQW18AN91NJ00	91 ±5%	230	0.64	34 at 150MHz	1900 min.
LQW18ANR10J00	100 ±5%	220	0.68	34 at 150MHz	1800 min.
LQW18ANR11J00	110 ±5%	220	1.2	32 at 150MHz	1350 min.
LQW18ANR12J00	120 ±5%	180	1.3	32 at 150MHz	1600 min.
LQW18ANR13J00	130 ±5%	170	1.4	32 at 150MHz	1450 min.
LQW18ANR15J00	150 ±5%	160	1.5	32 at 150MHz	1400 min.
LQW18ANR16J00	160 ±5%	150	2.1	32 at 150MHz	1350 min.
LQW18ANR18J00	180 ±5%	140	2.2	25 at 100MHz	1300 min.
LQW18ANR20J00	200 ±5%	120	2.4	25 at 100MHz	1250 min.
LQW18ANR22J00	220 ±5%	120	2.5	25 at 100MHz	1200 min.

Min. of Operating Temp. : -25°C to 85°C

■ Q-Frequency Characteristics

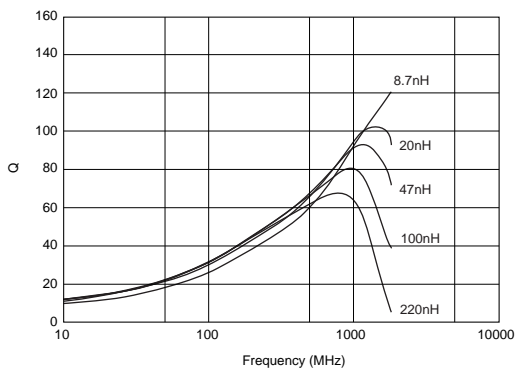

■ Inductance-Frequency Characteristics

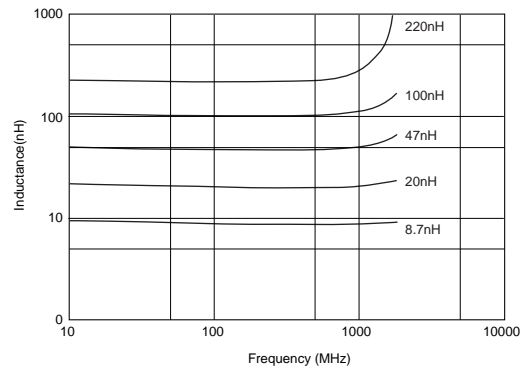

# CHIP COILS



## High-frequency Winding Type LQW2BH/LQW31H Series

### LQW2BH Series

The LQW2BH series consists of air-core chip coil using a sub-miniature alumina core as a bobbin. The high Q value at high frequencies and high self-resonant frequencies make this coil perfect for use in the high frequency circuits of communications equipment.

#### ■ Features

1. LQW2BH series covers inductance range from 3.3nH to 470nH.
2. Their high self-resonant frequency characteristic yields a high Q value and highly stable inductance at high frequencies.
3. Low DC resistance design enables to handle higher allowable current.
4. The series has excellent solder heat resistance. Both flow and reflow soldering methods can be employed.

#### • LQW2BHN\_J01

Inductance tolerance  $\pm 0.5\text{nH}$  (8.2nH max.),  $\pm 5\%$  (10nH to 470nH) is realized. The sub miniature dimensions (2.0x1.5mm) allow high density mounting.

#### • LQW2BHN\_G01 (Tight inductance tolerance)

Tight inductance tolerance of  $\pm 2\%$  is available.

#### • LQW2BHN\_11

LQW2BHN\_11 using thick wire (0.12mm in diameter) has higher Q value than existing LQW2BH series.

Low DC resistance design enables to handle higher current.

LQW2BHN\_11 covers inductance range from 2.7nH to 27nH.

#### ■ Applications

- High frequency circuit in telecommunication equipment, such as DECT, PHS, PCS, PCN, GSM and CDMA.
- Impedance Matching -- Power-AMP Module (PA)
- SAW filter Resonance circuits -- VCO

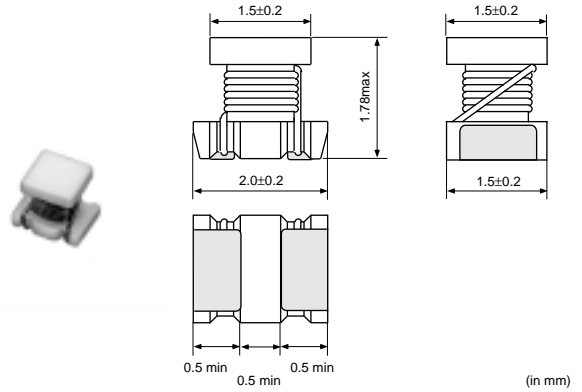

4

Part Number	Inductance (nH)	Rated Current (mA)	Max. of DC resistance (ohm)	Q (min.)	Self Resonance Frequency (MHz)
LQW2BHN2N7D11	2.7 $\pm 0.5\text{nH}$	1900	0.02	20 at 250MHz	6000 min.
LQW2BHN3N1D11	3.1 $\pm 0.5\text{nH}$	1800	0.02	20 at 250MHz	6000 min.
LQW2BHN3N3D01	3.3 $\pm 0.5\text{nH}$	910	0.05	10 at 250MHz	6000 min.
LQW2BHN3N3D11	3.3 $\pm 0.5\text{nH}$	1700	0.02	20 at 250MHz	6000 min.
LQW2BHN5N6D11	5.6 $\pm 0.5\text{nH}$	1500	0.02	35 at 250MHz	6000 min.
LQW2BHN6N8D01	6.8 $\pm 0.5\text{nH}$	680	0.11	20 at 250MHz	5400 min.
LQW2BHN6N8D11	6.8 $\pm 0.5\text{nH}$	1400	0.02	35 at 250MHz	5400 min.
LQW2BHN8N2D01	8.2 $\pm 0.5\text{nH}$	630	0.12	20 at 250MHz	3900 min.
LQW2BHN8N6D11	8.6 $\pm 0.5\text{nH}$	1300	0.03	35 at 250MHz	3900 min.
LQW2BHN33NG01	33 $\pm 2\%$	570	0.15	40 at 250MHz	1900 min.
LQW2BHN39NG01	39 $\pm 2\%$	730	0.09	40 at 250MHz	1700 min.
LQW2BHN47NG01	47 $\pm 2\%$	450	0.23	40 at 200MHz	1600 min.

Continued on the following page.

Continued from the preceding page.

Part Number	Inductance (nH)	Rated Current (mA)	Max. of DC resistance (ohm)	Q (min.)	Self Resonance Frequency (MHz)
LQW2BHN56NG01	56 ±2%	430	0.26	40 at 200MHz	1500 min.
LQW2BHN68NG01	68 ±2%	460	0.23	40 at 200MHz	1200 min.
LQW2BHN82NG01	82 ±2%	320	0.42	40 at 150MHz	1100 min.
LQW2BHNR10G01	100 ±2%	270	0.55	35 at 150MHz	900 min.
LQW2BHNR12G01	120 ±2%	320	0.40	40 at 150MHz	750 min.
LQW2BHNR15G01	150 ±2%	260	0.68	30 at 150MHz	350 min.
LQW2BHNR18G01	180 ±2%	250	0.71	35 at 100MHz	700 min.
LQW2BHNR22G01	220 ±2%	240	0.7	35 at 100MHz	500 min.
LQW2BHN10NJ01	10 ±5%	1320	0.03	30 at 250MHz	3300 min.
LQW2BHN10NJ11	10 ±5%	1320	0.03	35 at 250MHz	3300 min.
LQW2BHN12NJ01	12 ±5%	680	0.11	30 at 250MHz	3200 min.
LQW2BHN15NJ01	15 ±5%	630	0.12	30 at 250MHz	2700 min.
LQW2BHN18NJ01	18 ±5%	690	0.1	30 at 250MHz	2600 min.
LQW2BHN22NJ01	22 ±5%	720	0.09	30 at 250MHz	2100 min.
LQW2BHN27NJ01	27 ±5%	540	0.17	40 at 250MHz	2300 min.
LQW2BHN33NJ01	33 ±5%	570	0.15	40 at 250MHz	1900 min.
LQW2BHN39NJ01	39 ±5%	730	0.09	40 at 250MHz	1700 min.
LQW2BHN47NJ01	47 ±5%	450	0.23	40 at 200MHz	1600 min.
LQW2BHN56NJ01	56 ±5%	430	0.26	40 at 200MHz	1500 min.
LQW2BHN68NJ01	68 ±5%	460	0.23	40 at 200MHz	1200 min.
LQW2BHN82NJ01	82 ±5%	320	0.42	40 at 150MHz	1100 min.
LQW2BHNR10J01	100 ±5%	350	0.38	40 at 150MHz	900 min.
LQW2BHNR12J01	120 ±5%	320	0.40	40 at 150MHz	750 min.
LQW2BHNR15J01	150 ±5%	390	0.47	30 at 150MHz	350 min.
LQW2BHNR18J01	180 ±5%	250	0.71	35 at 100MHz	700 min.
LQW2BHNR22J01	220 ±5%	240	0.7	35 at 100MHz	500 min.
LQW2BHN12NK11	12 ±10%	1100	0.04	40 at 250MHz	3200 min.
LQW2BHN15NK11	15 ±10%	1000	0.04	40 at 250MHz	3100 min.
LQW2BHN18NK11	18.8 ±10%	1000	0.05	40 at 250MHz	2600 min.
LQW2BHN21NK11	21 ±10%	950	0.05	40 at 250MHz	2200 min.
LQW2BHN27NK11	27 ±10%	900	0.06	40 at 250MHz	1800 min.
LQW2BHN33NK01	33 ±10%	570	0.15	40 at 250MHz	1900 min.
LQW2BHN39NK01	39 ±10%	730	0.09	40 at 250MHz	1700 min.
LQW2BHN47NK01	47 ±10%	450	0.23	40 at 200MHz	1600 min.
LQW2BHN56NK01	56 ±10%	430	0.26	40 at 200MHz	1500 min.
LQW2BHN68NK01	68 ±10%	460	0.23	40 at 200MHz	1200 min.
LQW2BHN82NK01	82 ±10%	320	0.42	40 at 150MHz	1100 min.
LQW2BHNR10K01	100 ±10%	350	0.38	40 at 150MHz	900 min.
LQW2BHNR12K01	120 ±10%	320	0.40	40 at 150MHz	750 min.
LQW2BHNR15K01	150 ±10%	390	0.47	30 at 150MHz	350 min.
LQW2BHNR18K01	180 ±10%	250	0.71	35 at 100MHz	700 min.
LQW2BHNR22K01	220 ±10%	240	0.7	35 at 100MHz	500 min.
LQW2BHNR27K01	270 ±10%	190	2.0	15 at 25.2MHz	550 min.
LQW2BHNR33K01	330 ±10%	180	2.2	15 at 25.2MHz	500 min.
LQW2BHNR39K01	390 ±10%	170	2.5	15 at 25.2MHz	400 min.
LQW2BHNR47K01	470 ±10%	160	2.8	15 at 25.2MHz	350 min.

Min. of Operating Temp. : -25°C to 85°C

## Q-Frequency Characteristics

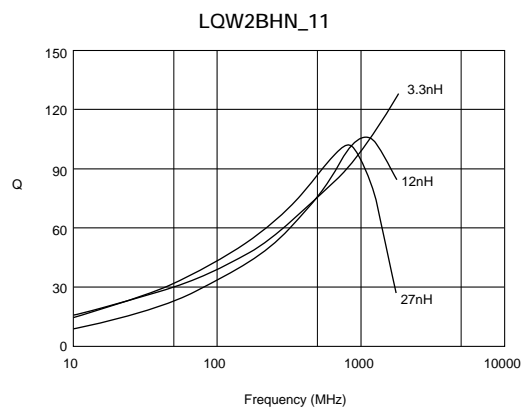
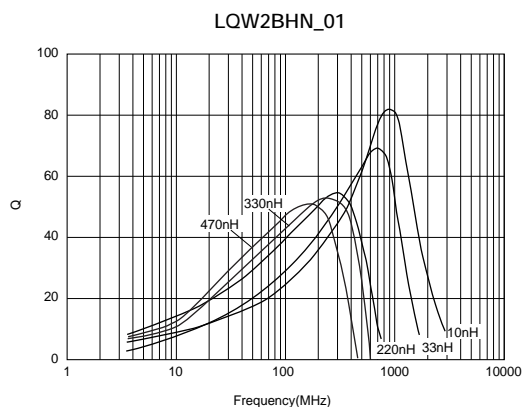

## Inductance-Frequency Characteristics

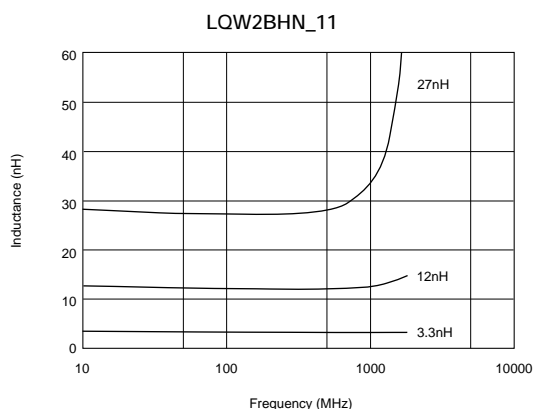

## LQW31H Series

### Features

The LQW31H series is alumina-core-type chip inductor for high frequency circuit. Its low dc resistance and high Q due to wound structure are suitable for hand telecommunication equipment.

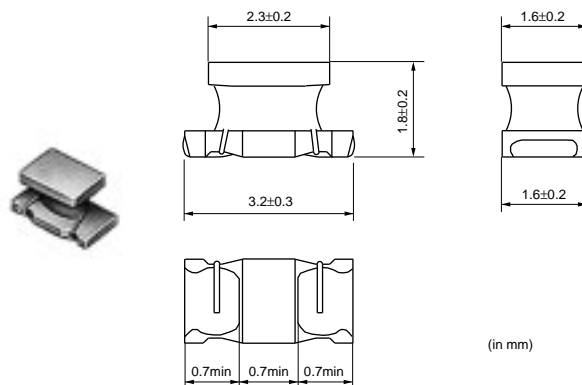

Part Number	Inductance (nH)	Rated Current (mA)	Max. of DC resistance (ohm)	Q (min.)	Self Resonance Frequency (MHz)
LQW31HN8N8J01	8.8 ±5%	750	0.0406	50 at 436MHz	1000 min.
LQW31HN15NJ01	14.7 ±5%	680	0.049	60 at 436MHz	1000 min.
LQW31HN17NJ01	17 ±5%	650	0.0518	60 at 436MHz	1000 min.
LQW31HN23NJ01	23 ±5%	590	0.0644	60 at 436MHz	1000 min.
LQW31HN27NJ01	27 ±5%	560	0.0714	60 at 436MHz	1000 min.
LQW31HN33NJ01	33 ±5%	530	0.0798	60 at 436MHz	1000 min.
LQW31HN39NJ01	39 ±5%	490	0.0938	60 at 436MHz	1000 min.
LQW31HN47NJ01	47 ±5%	380	0.154	60 at 436MHz	1000 min.
LQW31HN56NJ01	56 ±5%	330	0.196	60 at 436MHz	1000 min.
LQW31HN64NJ01	64 ±5%	290	0.252	60 at 436MHz	1000 min.
LQW31HN84NJ01	84 ±5%	240	0.392	60 at 436MHz	1000 min.
LQW31HNR10J01	100 ±5%	230	0.42	60 at 436MHz	900 min.
LQW31HN8N8K01	8.8 ±10%	750	0.0406	50 at 436MHz	1000 min.

Continued on the following page.

Continued from the preceding page.

Part Number	Inductance (nH)	Rated Current (mA)	Max. of DC resistance (ohm)	Q (min.)	Self Resonance Frequency (MHz)
LQW31HN15NK01	14.7 ±10%	680	0.049	60 at 436MHz	1000 min.
LQW31HN17NK01	17 ±10%	650	0.0518	60 at 436MHz	1000 min.
LQW31HN23NK01	23 ±10%	590	0.0644	60 at 436MHz	1000 min.
LQW31HN27NK01	27 ±10%	560	0.0714	60 at 436MHz	1000 min.
LQW31HN33NK01	33 ±10%	530	0.0798	60 at 436MHz	1000 min.
LQW31HN39NK01	39 ±10%	490	0.0938	60 at 436MHz	1000 min.
LQW31HN47NK01	47 ±10%	380	0.154	60 at 436MHz	1000 min.
LQW31HN56NK01	56 ±10%	330	0.196	60 at 436MHz	1000 min.
LQW31HN64NK01	64 ±10%	290	0.252	60 at 436MHz	1000 min.
LQW31HN84NK01	84 ±10%	240	0.392	60 at 436MHz	1000 min.
LQW31HNR10K01	100 ±10%	230	0.42	60 at 436MHz	900 min.

Min. of Operating Temp. : -25°C to 85°C

### ■ Q-Frequency Characteristics

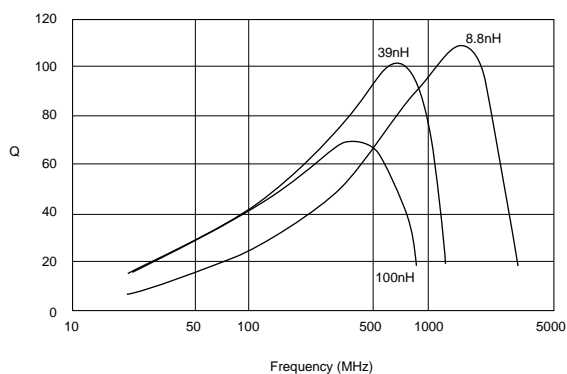

# CHIP COILS



## High-frequency Winding Type LQH31H Series

### LQH31H Series

#### ■ Features

The LQH31H series is wound type chip inductor with ferrite core. Its high Q values from 30MHz to 150MHz and low DC resistance are suitable in high frequency resonator.

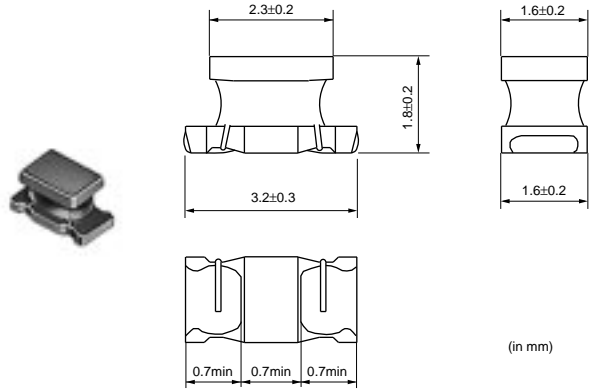

5

Part Number	Inductance (nH)	Rated Current (mA)	Max. of DC resistance (ohm)	Q (min.)	Self Resonance Frequency (MHz)
LQH31HN54NK01	54 ±10%	920	0.0455	50 at 100MHz	800 min.
LQH31HN95NK01	95 ±10%	790	0.0611	60 at 100MHz	650 min.
LQH31HNR14K01	145 ±10%	700	0.0793	60 at 100MHz	500 min.
LQH31HNR21K01	215 ±10%	520	0.143	60 at 100MHz	430 min.
LQH31HNR29K01	290 ±10%	420	0.221	60 at 100MHz	360 min.
LQH31HNR39K01	390 ±10%	330	0.338	60 at 100MHz	300 min.
LQH31HNR50K01	500 ±10%	260	0.572	60 at 100MHz	270 min.
LQH31HNR61K01	610 ±10%	250	0.624	60 at 100MHz	240 min.
LQH31HNR75K01	750 ±10%	190	1.027	60 at 100MHz	220 min.
LQH31HNR88K01	880 ±10%	180	1.118	60 at 100MHz	200 min.

Min. of Operating Temp. : -25°C to 85°C

#### ■ Q-Frequency Characteristics

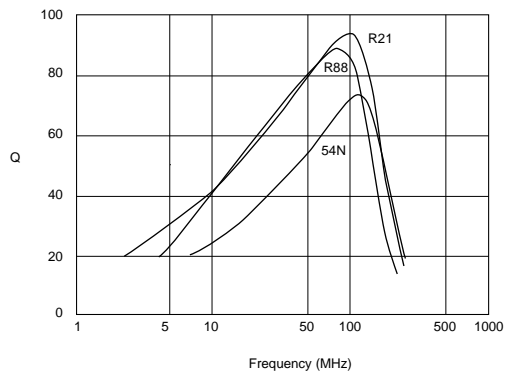

# CHIP COILS



## for General Use Monolithic Type LQM18N/LQM21N Series

### LQM18N Series

The LQM18N series, of magnetically shielded chip coil was developed by using original multilayer process technology and magnetic materials. Compact size is suitable for high density mounting. Shielded construction is not affected by interference from peripheral components.

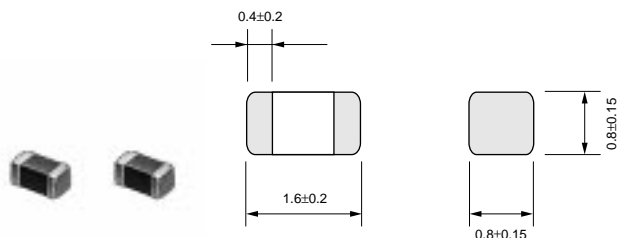

#### ■ Features

1. Magnetically shielded structure provides excellent characteristics in cross talk and magnetic coupling.
2. Compact size(1.6x0.8mm)and light weight.
3. The external electrodes with nickel barrier structure provide excellent solder heat resistance. Both flow and reflow soldering can be applicable.

#### ■ Applications

- Resonance circuit, traps, filter circuits
- RF choke in telecommunication equipments, cordless phone, radio equipments

Part Number	Inductance (nH)	Rated Current (mA)	Max. of DC resistance (ohm)	Q (min.)	Self Resonance Frequency (MHz)
LQM18NNR10K00	100 ±10%	50	0.50 max	15 at 25MHz	240 min.
LQM18NNR12K00	120 ±10%	50	0.50 max	15 at 25MHz	205 min.
LQM18NNR15K00	150 ±10%	50	0.60 max	15 at 25MHz	180 min.
LQM18NNR18K00	180 ±10%	50	0.60 max	15 at 25MHz	165 min.
LQM18NNR22K00	220 ±10%	50	0.80 max	15 at 25MHz	150 min.
LQM18NNR27K00	270 ±10%	50	0.80 max	15 at 25MHz	136 min.
LQM18NNR33K00	330 ±10%	35	0.85 max	15 at 25MHz	125 min.
LQM18NNR39K00	390 ±10%	35	1.00 max	15 at 25MHz	110 min.
LQM18NNR47K00	470 ±10%	35	1.35 max	15 at 25MHz	105 min.
LQM18NNR56K00	560 ±10%	35	1.55 max	15 at 25MHz	95 min.
LQM18NNR68K00	680 ±10%	35	1.70 max	15 at 25MHz	90 min.
LQM18NNR82K00	820 ±10%	35	2.10 max	15 at 25MHz	85 min.
LQM18NN1R0K00	1000 ±10%	25	0.60 max	35 at 10MHz	75 min.
LQM18NN1R2K00	1200 ±10%	25	0.80 max	35 at 10MHz	65 min.
LQM18NN1R5K00	1500 ±10%	25	0.80 max	35 at 10MHz	60 min.
LQM18NN1R8K00	1800 ±10%	25	0.95 max	35 at 10MHz	55 min.
LQM18NN2R2K00	2200 ±10%	15	1.15 max	35 at 10MHz	50 min.
LQM18NN47NM00	47 ±20%	50	0.30 max	10 at 50MHz	260 min.
LQM18NN68NM00	68 ±20%	50	0.30 max	10 at 50MHz	250 min.
LQM18NN82NM00	82 ±20%	50	0.30 max	10 at 50MHz	245 min.

Min. of Operating Temp. : -25°C to +85°C

## Q-Frequency Characteristics

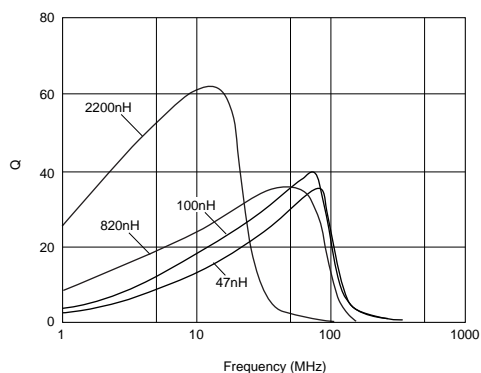

## Inductance-Current Characteristics

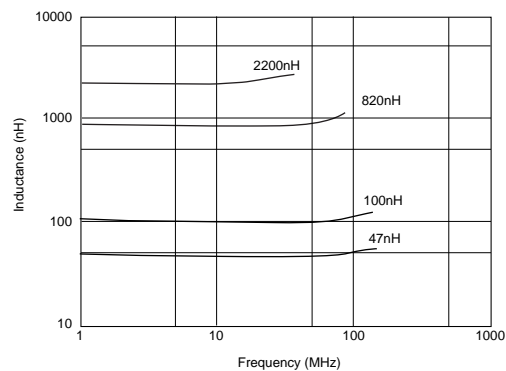

## LQM21N Series

### Features

The LQM21N series consists of magnetically shielded chip inductors developed using Murata's original multilayer process technology and magnetic materials.

The miniature size of 2.0mmx1.25mm enables compact design of electric equipment. Inductance range from 0.10 micro H to 4.7 micro H are available.

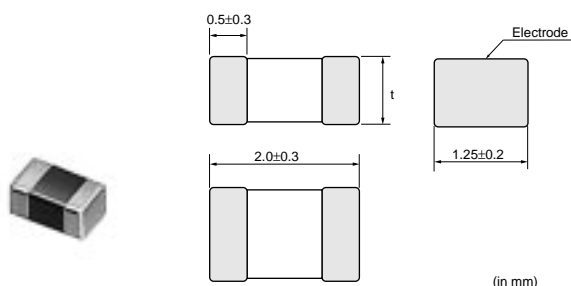

Part Number	t
LQM21NNR10K10 to N2R2K10	0.85±0.2
LQM21NN2R7K10 to N4R7K10	1.25±0.2

Part Number	Inductance (μH)	Rated Current (mA)	Max. of DC resistance (ohm)	Q (min.)	Self Resonance Frequency (MHz)
LQM21NNR10K10	0.1 ±10%	250	0.26	20 at 25MHz	340 min.
LQM21NNR12K10	0.12 ±10%	250	0.29	20 at 25MHz	310 min.
LQM21NNR15K10	0.15 ±10%	250	0.32	20 at 25MHz	270 min.
LQM21NNR18K10	0.18 ±10%	250	0.35	20 at 25MHz	250 min.
LQM21NNR22K10	0.22 ±10%	250	0.38	20 at 25MHz	220 min.
LQM21NNR27K10	0.27 ±10%	250	0.42	20 at 25MHz	200 min.
LQM21NNR33K10	0.33 ±10%	250	0.48	20 at 25MHz	180 min.
LQM21NNR39K10	0.39 ±10%	200	0.53	25 at 25MHz	165 min.
LQM21NNR47K10	0.47 ±10%	200	0.57	25 at 25MHz	150 min.
LQM21NNR56K10	0.56 ±10%	150	0.63	25 at 25MHz	140 min.
LQM21NNR68K10	0.68 ±10%	150	0.72	25 at 25MHz	125 min.
LQM21NNR82K10	0.82 ±10%	150	0.81	25 at 25MHz	115 min.
LQM21NN1R0K10	1 ±10%	50	0.40	45 at 10MHz	107 min.
LQM21NN1R2K10	1.2 ±10%	50	0.47	at 10MHz	97 min.
LQM21NN1R5K10	1.5 ±10%	50	0.50	45 at 10MHz	87 min.
LQM21NN1R8K10	1.8 ±10%	50	0.57	30 at 10MHz	80 min.
LQM21NN2R2K10	2.2 ±10%	30	0.63	45 at 10MHz	71 min.
LQM21NN2R7K10	2.7 ±10%	30	0.69	45 at 10MHz	66 min.
LQM21NN3R3K10	3.3 ±10%	30	0.80	45 at 10MHz	59 min.
LQM21NN3R9K10	3.9 ±10%	30	0.89	45 at 10MHz	53 min.
LQM21NN4R7K10	4.7 ±10%	30	1.00	45 at 10MHz	47 min.

Min. of Operating Temp. : -40°C to 85°C

### ■ Q-Frequency Characteristics

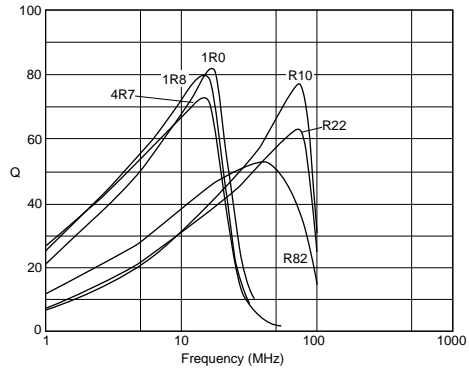

### ■ Inductance-Current Characteristics

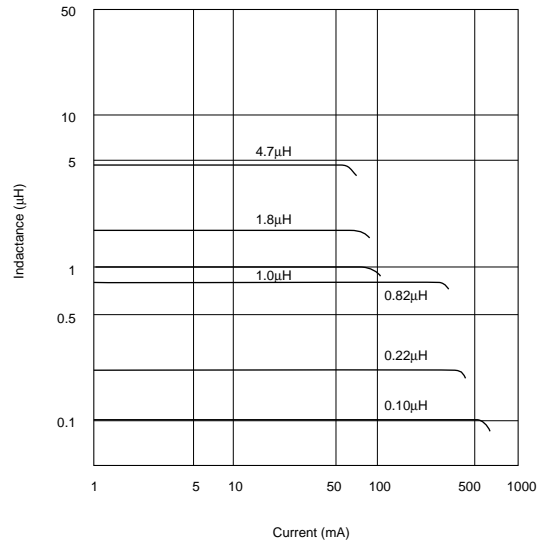

# CHIP COILS



## for General Use Winding Type LQH31M/LQH32M/LQH43M(N) Series

### LQH31M Series

#### ■ Features

The chip inductor LQH31M series consists of miniature chip inductors wound on a special ferrite core. It have a high Q value at high frequencies and low DC resistance. Wide inductance range from 0.15 micro H to 100 micro H are available.

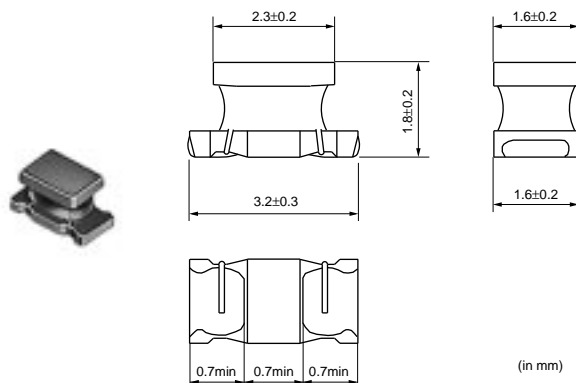

Part Number	Inductance (μH)	Rated Current (mA)	Max. of DC resistance (ohm)	Q (min.)	Self Resonance Frequency (MHz)
LQH31MN1R5J01	1.5 ±5%	155	1.3	35 at 10MHz	75 min.
LQH31MN1R8J01	1.8 ±5%	150	2.08	35 at 10MHz	60 min.
LQH31MN2R2J01	2.2 ±5%	140	0.91	35 at 10MHz	50 min.
LQH31MN2R7J01	2.7 ±5%	135	0.715	35 at 10MHz	43 min.
LQH31MN3R3J01	3.3 ±5%	130	1.82	35 at 8MHz	38 min.
LQH31MN3R9J01	3.9 ±5%	125	1.95	35 at 8MHz	35 min.
LQH31MN4R7J01	4.7 ±5%	120	2.21	35 at 8MHz	31 min.
LQH31MN5R6J01	5.6 ±5%	115	2.34	35 at 8MHz	28 min.
LQH31MN6R8J01	6.8 ±5%	110	2.6	35 at 8MHz	25 min.
LQH31MN8R2J01	8.2 ±5%	105	2.86	35 at 8MHz	23 min.
LQH31MN100J01	10 ±5%	100	3.25	35 at 5MHz	20 min.
LQH31MN120J01	12 ±5%	95	3.51	35 at 5MHz	18 min.
LQH31MN150J01	15 ±5%	90	3.9	35 at 5MHz	16 min.
LQH31MN180J01	18 ±5%	85	4.42	35 at 5MHz	15 min.
LQH31MN220J01	22 ±5%	85	4.03	40 at 2.5MHz	14 min.
LQH31MN270J01	27 ±5%	85	4.42	40 at 2.5MHz	13 min.
LQH31MN330J01	33 ±5%	80	4.94	40 at 2.5MHz	12 min.
LQH31MN390J01	39 ±5%	55	9.36	40 at 2.5MHz	11 min.
LQH31MN470J01	47 ±5%	55	10.4	40 at 2.5MHz	10 min.
LQH31MN560J01	56 ±5%	50	11.57	40 at 2.5MHz	9 min.
LQH31MN680J01	68 ±5%	50	12.87	40 at 2.5MHz	8.5 min.
LQH31MN820J01	82 ±5%	45	14.3	40 at 2.5MHz	7.5 min.
LQH31MN101J01	100 ±5%	45	15.6	40 at 2.5MHz	7 min.
LQH31MNR15K01	0.15 ±10%	250	0.546	20 at 25MHz	250 min.
LQH31MNR22K01	0.22 ±10%	240	0.602	20 at 25MHz	250 min.
LQH31MNR33K01	0.33 ±10%	230	0.63	30 at 25MHz	250 min.
LQH31MNR47K01	0.47 ±10%	215	1.162	30 at 25MHz	200 min.
LQH31MNR56K01	0.56 ±10%	200	0.854	30 at 25MHz	180 min.
LQH31MNR68K01	0.68 ±10%	190	0.938	30 at 25MHz	160 min.
LQH31MNR82K01	0.82 ±10%	185	1.022	30 at 25MHz	120 min.
LQH31MN1R0K01	1.0 ±10%	175	0.637	35 at 10MHz	100 min.
LQH31MN1R2K01	1.2 ±10%	165	1.17	35 at 10MHz	90 min.
LQH31MN1R5K01	1.5 ±10%	155	1.3	35 at 10MHz	75 min.
LQH31MN1R8K01	1.8 ±10%	150	2.08	35 at 10MHz	60 min.
LQH31MN2R2K01	2.2 ±10%	140	0.91	35 at 10MHz	50 min.
LQH31MN2R7K01	2.7 ±10%	135	0.715	35 at 10MHz	43 min.

Continued on the following page.

Continued from the preceding page.

Part Number	Inductance (μH)	Rated Current (mA)	Max. of DC resistance (ohm)	Q (min.)	Self Resonance Frequency (MHz)
LQH31MN3R3K01	3.3 ±10%	130	1.82	35 at 8MHz	38 min.
LQH31MN3R9K01	3.9 ±10%	125	1.95	35 at 8MHz	35 min.
LQH31MN4R7K01	4.7 ±10%	120	2.21	35 at 8MHz	31 min.
LQH31MN5R6K01	5.6 ±10%	115	2.34	35 at 8MHz	28 min.
LQH31MN6R8K01	6.8 ±10%	110	2.6	35 at 8MHz	25 min.
LQH31MN8R2K01	8.2 ±10%	105	2.86	35 at 8MHz	23 min.
LQH31MN100K01	10 ±10%	100	3.25	35 at 5MHz	20 min.
LQH31MN120K01	12 ±10%	95	3.51	35 at 5MHz	18 min.
LQH31MN150K01	15 ±10%	90	3.9	35 at 5MHz	16 min.
LQH31MN180K01	18 ±10%	85	4.42	35 at 5MHz	15 min.
LQH31MN220K01	22 ±10%	85	4.03	40 at 2.5MHz	14 min.
LQH31MN270K01	27 ±10%	85	4.42	40 at 2.5MHz	13 min.
LQH31MN330K01	33 ±10%	80	4.94	40 at 2.5MHz	12 min.
LQH31MN390K01	39 ±10%	55	9.36	40 at 2.5MHz	11 min.
LQH31MN470K01	47 ±10%	55	10.4	40 at 2.5MHz	10 min.
LQH31MN560K01	56 ±10%	50	11.57	40 at 2.5MHz	9 min.
LQH31MN680K01	68 ±10%	50	12.87	40 at 2.5MHz	8.5 min.
LQH31MN820K01	82 ±10%	45	14.3	40 at 2.5MHz	7.5 min.
LQH31MN101K01	100 ±10%	45	15.6	40 at 2.5MHz	7 min.

Min. of Operating Temp. : -25°C to 85°C

7

### Q-Frequency Characteristics

### Inductance-Current Characteristics

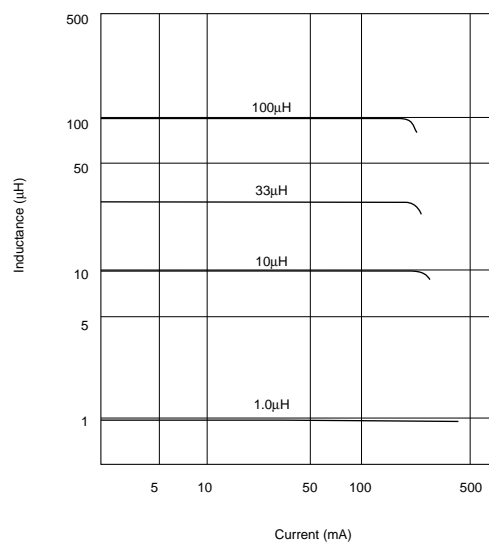
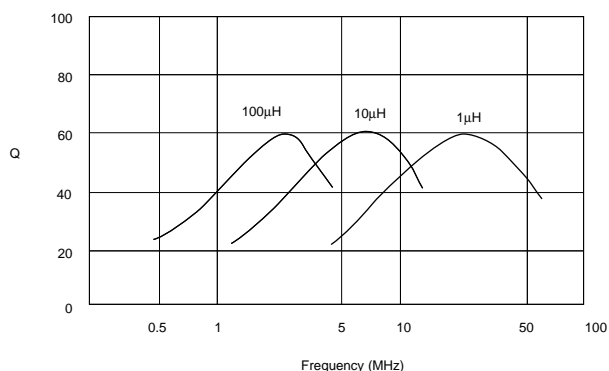

### Coupling Coefficient

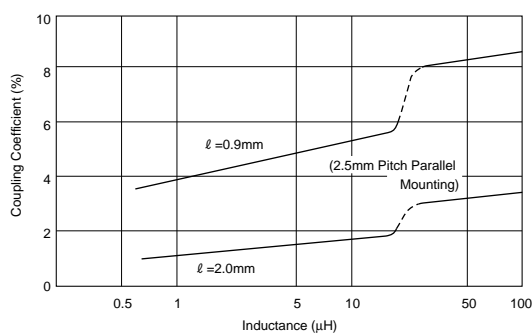

## LQH32M Series

### ■ Features

The chip inductor LQH32M series consists of miniature chip inductors wound on a special ferrite core. It have a high Q value at high frequencies and low DC resistance. Wide inductance range from 0.10 micro H to 560 micro H are available.

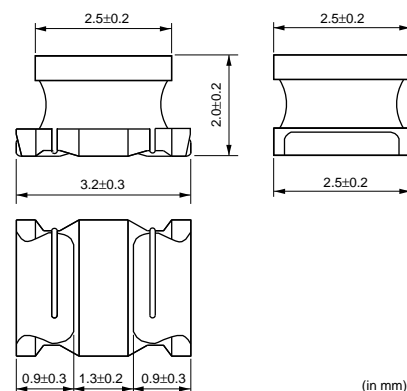

Part Number	Inductance (μH)	Rated Current (mA)	Max. of DC resistance (ohm)	Q (min.)	Self Resonance Frequency (MHz)
LQH32MN100J21	10 ±5%	190	1.8	35 at 1MHz	20 min.
LQH32MN120J21	12 ±5%	180	2	35 at 1MHz	18 min.
LQH32MN150J21	15 ±5%	170	2.2	35 at 1MHz	16 min.
LQH32MN180J21	18 ±5%	165	2.5	35 at 1MHz	15 min.
LQH32MN220J21	22 ±5%	150	2.8	35 at 1MHz	14 min.
LQH32MN270J21	27 ±5%	125	3.1	35 at 1MHz	13 min.
LQH32MN330J21	33 ±5%	115	3.5	40 at 1MHz	12 min.
LQH32MN390J21	39 ±5%	110	3.9	40 at 1MHz	11 min.
LQH32MN470J21	47 ±5%	100	4.3	40 at 1MHz	11 min.
LQH32MN560J21	56 ±5%	85	4.9	40 at 1MHz	10 min.
LQH32MN680J21	68 ±5%	80	5.5	40 at 1MHz	9 min.
LQH32MN820J21	82 ±5%	70	6.2	40 at 1MHz	8.5 min.
LQH32MN101J21	100 ±5%	80	7	40 at 0.796MHz	8 min.
LQH32MN121J21	120 ±5%	75	8	40 at 0.796MHz	7.5 min.
LQH32MN151J21	150 ±5%	70	9.3	40 at 0.796MHz	7 min.
LQH32MN181J21	180 ±5%	65	10.2	40 at 0.796MHz	6 min.
LQH32MN221J21	220 ±5%	65	11.8	40 at 0.796MHz	5.5 min.
LQH32MN271J21	270 ±5%	65	12.5	40 at 0.796MHz	5 min.
LQH32MN331J21	330 ±5%	65	13	40 at 0.796MHz	5 min.
LQH32MN391J21	390 ±5%	50	22	50 at 0.796MHz	5 min.
LQH32MN471J21	470 ±5%	45	25	50 at 0.796MHz	5 min.
LQH32MN561J21	560 ±5%	40	28	50 at 0.796MHz	5 min.
LQH32MN1R5K21	1.5 ±10%	400	0.6	20 at 1MHz	75 min.
LQH32MN1R8K21	1.8 ±10%	390	0.7	20 at 1MHz	60 min.
LQH32MN2R2K21	2.2 ±10%	370	0.8	20 at 1MHz	50 min.
LQH32MN2R7K21	2.7 ±10%	320	0.9	20 at 1MHz	43 min.
LQH32MN3R3K21	3.3 ±10%	300	1	20 at 1MHz	38 min.
LQH32MN3R9K21	3.9 ±10%	290	1.1	20 at 1MHz	35 min.
LQH32MN4R7K21	4.7 ±10%	270	1.2	20 at 1MHz	31 min.
LQH32MN5R6K21	5.6 ±10%	250	1.3	20 at 1MHz	28 min.
LQH32MN6R8K21	6.8 ±10%	240	1.5	20 at 1MHz	25 min.
LQH32MN8R2K21	8.2 ±10%	225	1.6	20 at 1MHz	23 min.
LQH32MN100K21	10 ±10%	190	1.8	35 at 1MHz	20 min.
LQH32MN120K21	12 ±10%	180	2	35 at 1MHz	18 min.
LQH32MN150K21	15 ±10%	170	2.2	35 at 1MHz	16 min.
LQH32MN180K21	18 ±10%	165	2.5	35 at 1MHz	15 min.
LQH32MN220K21	22 ±10%	150	2.8	35 at 1MHz	14 min.
LQH32MN270K21	27 ±10%	125	3.1	35 at 1MHz	13 min.
LQH32MN330K21	33 ±10%	115	3.5	40 at 1MHz	12 min.
LQH32MN390K21	39 ±10%	110	3.9	40 at 1MHz	11 min.
LQH32MN470K21	47 ±10%	100	4.3	40 at 1MHz	11 min.
LQH32MN560K21	56 ±10%	85	4.9	40 at 1MHz	10 min.

Continued on the following page.

Continued from the preceding page.

Part Number	Inductance (μH)	Rated Current (mA)	Max. of DC resistance (ohm)	Q (min.)	Self Resonance Frequency (MHz)
LQH32MN680K21	68 ±10%	80	5.5	40 at 1MHz	9 min.
LQH32MN820K21	82 ±10%	70	6.2	40 at 1MHz	8.5 min.
LQH32MN101K21	100 ±10%	80	7	40 at 0.796MHz	8 min.
LQH32MN121K21	120 ±10%	75	8	40 at 0.796MHz	7.5 min.
LQH32MN151K21	150 ±10%	70	9.3	40 at 0.796MHz	7 min.
LQH32MN181K21	180 ±10%	65	10.2	40 at 0.796MHz	6 min.
LQH32MN221K21	220 ±10%	65	11.8	40 at 0.796MHz	5.5 min.
LQH32MN271K21	270 ±10%	65	12.5	40 at 0.796MHz	5 min.
LQH32MN331K21	330 ±10%	65	13	40 at 0.796MHz	5 min.
LQH32MN391K21	390 ±10%	50	22	50 at 0.796MHz	5 min.
LQH32MN471K21	470 ±10%	45	25	50 at 0.796MHz	5 min.
LQH32MN561K21	560 ±10%	40	28	50 at 0.796MHz	5 min.
LQH32MNR10M21	0.1 ±20%	700	0.25	20 at 25.2MHz	200 min.
LQH32MNR18M21	0.18 ±20%	650	0.25	20 at 25.2MHz	200 min.
LQH32MNR27M21	0.27 ±20%	600	0.25	25 at 25.2MHz	200 min.
LQH32MNR39M21	0.39 ±20%	530	0.25	25 at 25.2MHz	200 min.
LQH32MNR56M21	0.56 ±20%	530	0.25	30 at 25.2MHz	160 min.
LQH32MNR68M21	0.68 ±20%	470	0.25	30 at 25.2MHz	160 min.
LQH32MNR82M21	0.82 ±20%	450	0.25	30 at 25.2MHz	120 min.
LQH32MN1R0M21	1 ±20%	445	0.5	20 at 1MHz	100 min.
LQH32MN1R2M21	1.2 ±20%	425	0.6	20 at 1MHz	100 min.

Min. of Operating Temp. : -25°C to 85°C

7

### Q-Frequency Characteristics

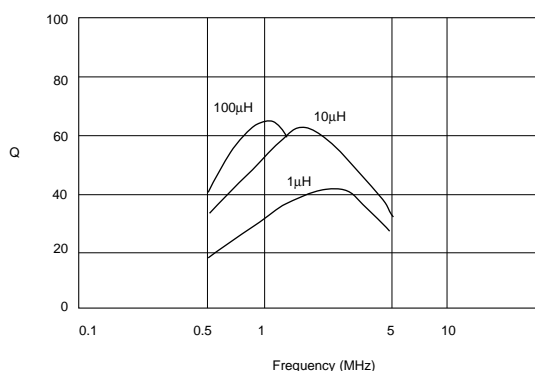

### Inductance-Current Characteristics

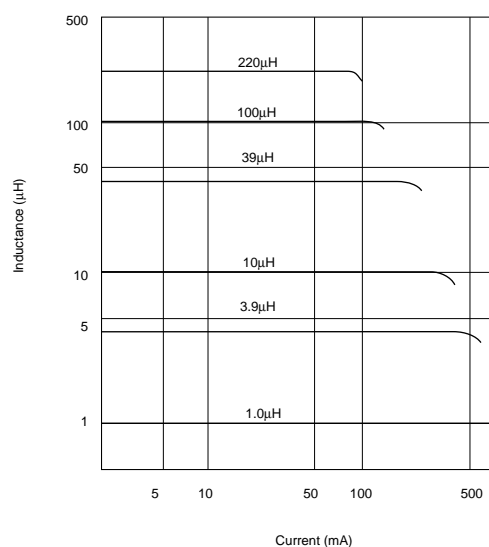

## LQH43M/N Series

### Features

The chip inductor LQH43M series consists of miniature chip inductors wound on a special ferrite core. It has a high Q value at high frequencies and low DC resistance. Wide inductance range from 1.0 micro H to 2200 micro H are available.

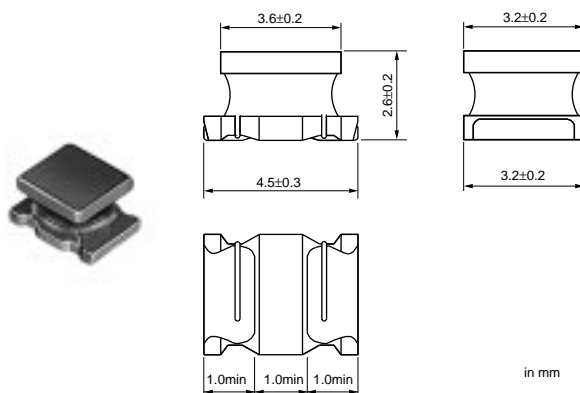

Part Number	Inductance (μH)	Rated Current (mA)	Max. of DC resistance (ohm)	Q (min.)	Self Resonance Frequency (MHz)
LQH43MN100J01	10 ±5%	400	0.56	35 at 1MHz	23 min.
LQH43MN120J01	12 ±5%	380	0.62	35 at 1MHz	21 min.
LQH43MN150J01	15 ±5%	360	0.73	35 at 1MHz	19 min.
LQH43MN180J01	18 ±5%	340	0.82	35 at 1MHz	17 min.
LQH43MN220J01	22 ±5%	320	0.94	35 at 1MHz	15 min.
LQH43MN270J01	27 ±5%	300	1.1	35 at 1MHz	14 min.
LQH43MN330J01	33 ±5%	270	1.2	35 at 1MHz	12 min.
LQH43MN390J01	39 ±5%	240	1.4	35 at 1MHz	11 min.
LQH43MN470J01	47 ±5%	220	1.5	35 at 1MHz	10 min.
LQH43MN560J01	56 ±5%	200	1.7	35 at 1MHz	9.3 min.
LQH43MN680J01	68 ±5%	180	1.9	35 at 1MHz	8.4 min.
LQH43MN820J01	82 ±5%	170	2.2	35 at 1MHz	7.5 min.
LQH43MN101J01	100 ±5%	160	2.5	40 at 0.796MHz	6.8 min.
LQH43MN121J01	120 ±5%	150	3	40 at 0.796MHz	6.2 min.
LQH43MN151J01	150 ±5%	130	3.7	40 at 0.796MHz	5.5 min.
LQH43MN181J01	180 ±5%	120	4.5	40 at 0.796MHz	5 min.
LQH43MN221J01	220 ±5%	110	5.4	40 at 0.796MHz	4.5 min.
LQH43MN271J01	270 ±5%	100	6.8	40 at 0.796MHz	4 min.
LQH43MN331J01	330 ±5%	95	8.2	40 at 0.796MHz	3.6 min.
LQH43MN391J01	390 ±5%	90	9.7	40 at 0.796MHz	3.3 min.
LQH43MN471J01	470 ±5%	80	11.8	40 at 0.796MHz	3 min.
LQH43MN561J01	560 ±5%	70	14.5	40 at 0.796MHz	2.7 min.
LQH43MN681J01	680 ±5%	65	17	40 at 0.796MHz	2.5 min.
LQH43MN821J01	820 ±5%	60	20.5	40 at 0.796MHz	2.2 min.
LQH43MN102J01	1000 ±5%	50	25	40 at 0.252MHz	2 min.
LQH43MN122J01	1200 ±5%	45	30	40 at 0.252MHz	1.8 min.
LQH43MN152J01	1500 ±5%	40	37	40 at 0.252MHz	1.6 min.
LQH43NN182J01	1800 ±5%	35	45	40 at 0.252MHz	1.5 min.
LQH43NN222J01	2200 ±5%	30	50	40 at 0.252MHz	1.3 min.
LQH43MN4R7K01	4.7 ±10%	500	0.4	30 at 1MHz	38 min.
LQH43MN5R6K01	5.6 ±10%	500	0.47	30 at 1MHz	33 min.
LQH43MN6R8K01	6.8 ±10%	450	0.5	30 at 1MHz	31 min.
LQH43MN8R2K01	8.2 ±10%	450	0.56	30 at 1MHz	27 min.
LQH43MN100K01	10 ±10%	400	0.56	35 at 1MHz	23 min.
LQH43MN120K01	12 ±10%	380	0.62	35 at 1MHz	21 min.
LQH43MN150K01	15 ±10%	360	0.73	35 at 1MHz	19 min.
LQH43MN180K01	18 ±10%	340	0.82	35 at 1MHz	17 min.
LQH43MN220K01	22 ±10%	320	0.94	35 at 1MHz	15 min.
LQH43MN270K01	27 ±10%	300	1.1	35 at 1MHz	14 min.
LQH43MN330K01	33 ±10%	270	1.2	35 at 1MHz	12 min.
LQH43MN390K01	39 ±10%	240	1.4	35 at 1MHz	11 min.
LQH43MN470K01	47 ±10%	220	1.5	35 at 1MHz	10 min.
LQH43MN560K01	56 ±10%	200	1.7	35 at 1MHz	9.3 min.
LQH43MN680K01	68 ±10%	180	1.9	35 at 1MHz	8.4 min.
LQH43MN820K01	82 ±10%	170	2.2	35 at 1MHz	7.5 min.
LQH43MN101K01	100 ±10%	160	2.5	40 at 0.796MHz	6.8 min.
LQH43MN121K01	120 ±10%	150	3	40 at 0.796MHz	6.2 min.
LQH43MN151K01	150 ±10%	130	3.7	40 at 0.796MHz	5.5 min.
LQH43MN181K01	180 ±10%	120	4.5	40 at 0.796MHz	5 min.
LQH43MN221K01	220 ±10%	110	5.4	40 at 0.796MHz	4.5 min.
LQH43MN271K01	270 ±10%	100	6.8	40 at 0.796MHz	4 min.
LQH43MN331K01	330 ±10%	95	8.2	40 at 0.796MHz	3.6 min.
LQH43MN391K01	390 ±10%	90	9.7	40 at 0.796MHz	3.3 min.
LQH43MN471K01	470 ±10%	80	11.8	40 at 0.796MHz	3 min.
LQH43MN561K01	560 ±10%	70	14.5	40 at 0.796MHz	2.7 min.
LQH43MN681K01	680 ±10%	65	17	40 at 0.796MHz	2.5 min.
LQH43MN821K01	820 ±10%	60	20.5	40 at 0.796MHz	2.2 min.

7

Continued on the following page. 

Continued from the preceding page.

Part Number	Inductance (μH)	Rated Current (mA)	Max. of DC resistance (ohm)	Q (min.)	Self Resonance Frequency (MHz)
LQH43MN102K01	1000 ±10%	50	25	40 at 0.252MHz	2 min.
LQH43MN122K01	1200 ±10%	45	30	40 at 0.252MHz	1.8 min.
LQH43MN152K01	1500 ±10%	40	37	40 at 0.252MHz	1.6 min.
LQH43NN182K01	1800 ±10%	35	45	40 at 0.252MHz	1.5 min.
LQH43NN222K01	2200 ±10%	30	50	40 at 0.252MHz	1.3 min.
LQH43MN1R0M01	1 ±20%	500	0.2	20 at 1MHz	120 min.
LQH43MN1R2M01	1.2 ±20%	500	0.2	20 at 1MHz	100 min.
LQH43MN1R5M01	1.5 ±20%	500	0.3	20 at 1MHz	85 min.
LQH43MN1R8M01	1.8 ±20%	500	0.3	20 at 1MHz	75 min.
LQH43MN2R2M01	2.2 ±20%	500	0.3	20 at 1MHz	62 min.
LQH43MN2R7M01	2.7 ±20%	500	0.32	20 at 1MHz	53 min.
LQH43MN3R3M01	3.3 ±20%	500	0.35	20 at 1MHz	47 min.
LQH43MN3R9M01	3.9 ±20%	500	0.38	20 at 1MHz	41 min.

Min. of Operating Temp. : -25°C to 85°C

### Q-Frequency Characteristics

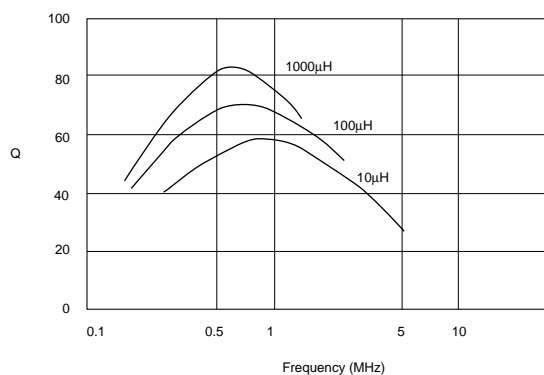

### Inductance-Current Characteristics

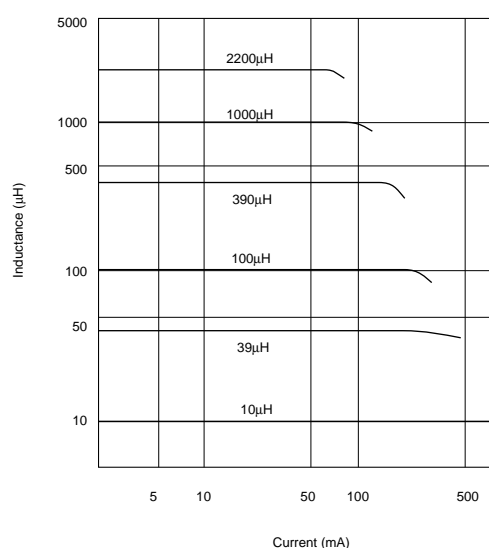

7

# CHIP COILS



## for General Use Magnetic Shielded Type LQH3ER Series

### LQH3ER Series

#### ■ Features

The LQH3ER series consists of magnetically shielded chip inductors. Its tight inductance tolerance of  $\pm 2\%$  enables no adjustment of circuit. The shielding structure eliminates external interference and facilitates high mounting density.

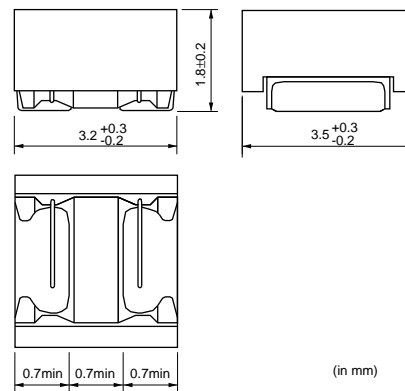

Part Number	Inductance ( $\mu\text{H}$ )	Rated Current (mA)	Max. of DC resistance (ohm)	Q (min.)	Self Resonance Frequency (MHz)
LQH3ERN1R0G01	1 $\pm 2\%$	70	0.247	60 at 7.96MHz	120 min.
LQH3ERN1R2G01	1.2 $\pm 2\%$	70	0.286	60 at 7.96MHz	100 min.
LQH3ERN1R5G01	1.5 $\pm 2\%$	70	0.338	60 at 7.96MHz	80 min.
LQH3ERN1R8G01	1.8 $\pm 2\%$	70	0.364	60 at 7.96MHz	70 min.
LQH3ERN2R2G01	2.2 $\pm 2\%$	50	0.429	60 at 7.96MHz	60 min.
LQH3ERN2R7G01	2.7 $\pm 2\%$	50	0.507	60 at 7.96MHz	55 min.
LQH3ERN3R3G01	3.3 $\pm 2\%$	50	0.559	60 at 7.96MHz	50 min.
LQH3ERN3R9G01	3.9 $\pm 2\%$	50	0.585	60 at 7.96MHz	45 min.
LQH3ERN4R7G01	4.7 $\pm 2\%$	30	0.676	60 at 7.96MHz	40 min.
LQH3ERN5R6G01	5.6 $\pm 2\%$	30	0.728	60 at 7.96MHz	37 min.
LQH3ERN6R8G01	6.8 $\pm 2\%$	30	0.806	60 at 7.96MHz	35 min.
LQH3ERN8R2G01	8.2 $\pm 2\%$	30	0.897	60 at 7.96MHz	32 min.
LQH3ERN100G01	10 $\pm 2\%$	15	1.222	70 at 2.52MHz	30 min.
LQH3ERN120G01	12 $\pm 2\%$	15	1.43	70 at 2.52MHz	27 min.
LQH3ERN150G01	15 $\pm 2\%$	15	1.56	70 at 2.52MHz	25 min.
LQH3ERN180G01	18 $\pm 2\%$	15	1.69	70 at 2.52MHz	23 min.
LQH3ERN220G01	22 $\pm 2\%$	10	1.95	70 at 2.52MHz	20 min.
LQH3ERN270G01	27 $\pm 2\%$	10	2.21	70 at 2.52MHz	18 min.
LQH3ERN330G01	33 $\pm 2\%$	10	3.12	80 at 2.52MHz	16 min.
LQH3ERN390G01	39 $\pm 2\%$	10	3.38	80 at 2.52MHz	15 min.
LQH3ERN470G01	47 $\pm 2\%$	10	3.9	80 at 2.52MHz	14 min.
LQH3ERN560G01	56 $\pm 2\%$	10	4.29	80 at 2.52MHz	13 min.
LQH3ERN680G01	68 $\pm 2\%$	10	6.89	80 at 2.52MHz	12 min.
LQH3ERN820G01	82 $\pm 2\%$	10	7.54	80 at 2.52MHz	11 min.
LQH3ERN101G01	100 $\pm 2\%$	10	8.58	80 at 2.52MHz	10 min.
LQH3ERN1R0J01	1 $\pm 5\%$	70	0.247	60 at 7.96MHz	120 min.
LQH3ERN1R2J01	1.2 $\pm 5\%$	70	0.286	60 at 7.96MHz	100 min.
LQH3ERN1R5J01	1.5 $\pm 5\%$	70	0.338	60 at 7.96MHz	80 min.
LQH3ERN1R8J01	1.8 $\pm 5\%$	70	0.364	60 at 7.96MHz	70 min.
LQH3ERN2R2J01	2.2 $\pm 5\%$	50	0.429	60 at 7.96MHz	60 min.
LQH3ERN2R7J01	2.7 $\pm 5\%$	50	0.507	60 at 7.96MHz	55 min.
LQH3ERN3R3J01	3.3 $\pm 5\%$	50	0.559	60 at 7.96MHz	50 min.
LQH3ERN3R9J01	3.9 $\pm 5\%$	50	0.585	60 at 7.96MHz	45 min.
LQH3ERN4R7J01	4.7 $\pm 5\%$	30	0.676	60 at 7.96MHz	40 min.
LQH3ERN5R6J01	5.6 $\pm 5\%$	30	0.728	60 at 7.96MHz	37 min.
LQH3ERN6R8J01	6.8 $\pm 5\%$	30	0.806	60 at 7.96MHz	35 min.

Continued on the following page.

Continued from the preceding page.

Part Number	Inductance (μH)	Rated Current (mA)	Max. of DC resistance (ohm)	Q (min.)	Self Resonance Frequency (MHz)
LQH3ERN8R2J01	8.2 ±5%	30	0.897	60 at 7.96MHz	32 min.
LQH3ERN100J01	10 ±5%	15	1.222	70 at 2.52MHz	30 min.
LQH3ERN120J01	12 ±5%	15	1.43	70 at 2.52MHz	27 min.
LQH3ERN150J01	15 ±5%	15	1.56	70 at 2.52MHz	25 min.
LQH3ERN180J01	18 ±5%	15	1.69	70 at 2.52MHz	23 min.
LQH3ERN220J01	22 ±5%	10	1.95	70 at 2.52MHz	20 min.
LQH3ERN270J01	27 ±5%	10	2.21	70 at 2.52MHz	18 min.
LQH3ERN330J01	33 ±5%	10	3.12	80 at 2.52MHz	16 min.
LQH3ERN390J01	39 ±5%	10	3.38	80 at 2.52MHz	15 min.
LQH3ERN470J01	47 ±5%	10	3.9	80 at 2.52MHz	14 min.
LQH3ERN560J01	56 ±5%	10	4.29	80 at 2.52MHz	13 min.
LQH3ERN680J01	68 ±5%	10	6.89	80 at 2.52MHz	12 min.
LQH3ERN820J01	82 ±5%	10	7.54	80 at 2.52MHz	11 min.
LQH3ERN101J01	100 ±5%	10	8.58	80 at 2.52MHz	10 min.

Min. of Operating Temp. : -25°C to 85°C

### Q-Frequency Characteristics

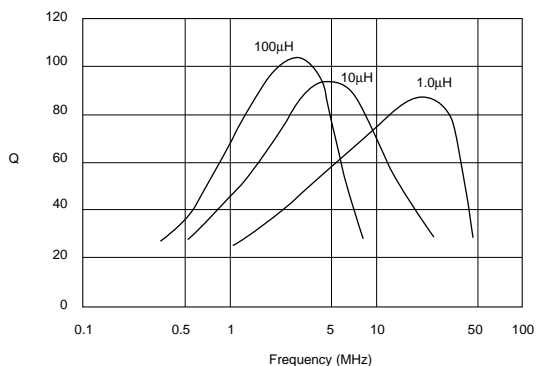

### Inductance-Current Characteristics

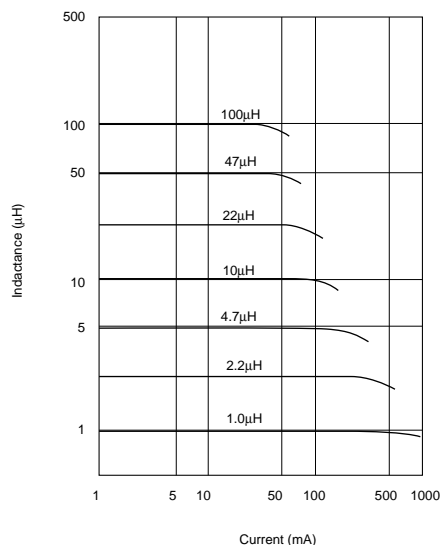

### Coupling Coefficient

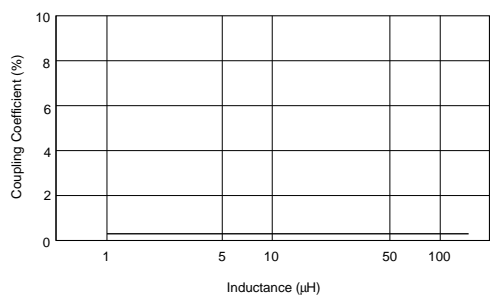

# CHIP COILS



## for Choke Monolithic Type LQM21D/LQM21F/LQM31F Series

### LQM21D/LQM21F Series

The LQM21D series consists of magnetically shielded chip inductors. It has less than half the DC resistance of our conventional monolithic chip inductors as well as high inductance.

#### ■ Features

1. The inductors have very low DC resistance.
2. The series has an inductance range of 1.0 micro H to 47 micro H.
3. Magnetically shielded structure provides excellent crosstalk characteristics.
4. Compact (2.0x1.25mm) and lightweight.
5. Outstanding solder heat resistance. Either flow or reflow soldering methods can be employed.

The LQM21F series consists of magnetically shielded chip coils based on Murata's technologies of multilayer process and magnetic materials. Excellent direct current characteristics are realized by using magnetic materials which have excellent saturation characteristics. The inductance of LQM21F is four times as large as that of conventional items.

#### ■ Features

1. LQM21F series is suitable for power line choke because of its excellent direct current characteristics. the series has large rated current (60mA at 10 micro H) than conventional rated current.
2. Low DC Resistance is realized.
3. The cross talk characteristics are excellent because of the use of magnetically shielded structure.
4. Small size(2.0x1.25mm)and light weight.
5. The series has excellent solder heat resistance. Both flow and reflow soldering can be employed.



LQM21D

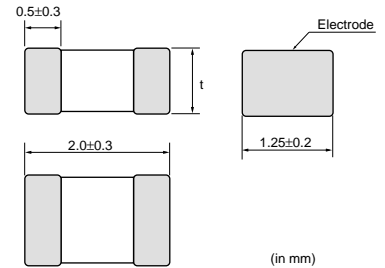

Part Number	t
LQM21DN1R0N00 to N100N00	0.85±0.2
LQM21DN220N00 to N470N00	1.25±0.2



LQM21F

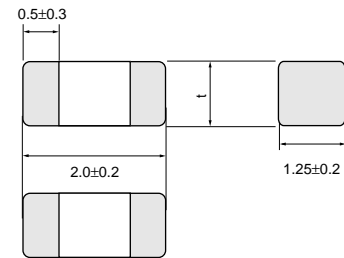

Part Number	t
LQM21FN1R0N00 to N2R2N00	0.85±0.2
LQM21FN4R7N00 to N470N00	1.25±0.2

Part Number	Inductance (μH)	Rated Current (mA)	Max. of DC resistance (ohm)	Self Resonance Frequency (MHz)
LQM21DN1R0N00	1 ±30%	60	0.1	75 min.
LQM21FN1R0N00	1.0 ±30%	220	0.26	105 min.
LQM21DN2R2N00	2.2 ±30%	40	0.17	50 min.
LQM21FN2R2N00	2.2 ±30%	150	0.364	70 min.
LQM21DN4R7N00	4.7 ±30%	30	0.3	35 min.
LQM21FN4R7N00	4.7 ±30%	80	0.39	25 min.
LQM21DN100N00	10 ±30%	15	0.5	24 min.
LQM21FN100N00	10 ±30%	60	0.65	15 min.
LQM21DN220N00	22 ±30%	13	0.65	16 min.
LQM21FN220N00	22 ±30%	13	0.455	15 min.
LQM21DN470N00	47 ±30%	7	1.2	7.5 min.

Continued on the following page.

Continued from the preceding page.

Part Number	Inductance (μH)	Rated Current (mA)	Max. of DC resistance (ohm)	Self Resonance Frequency (MHz)
<b>LQM21FN470N00</b>	47 ±30%	7	0.78	7.5 min.

Min. of Operating Temp. : -40°C to 85°C

### Impedance-Frequency Characteristics

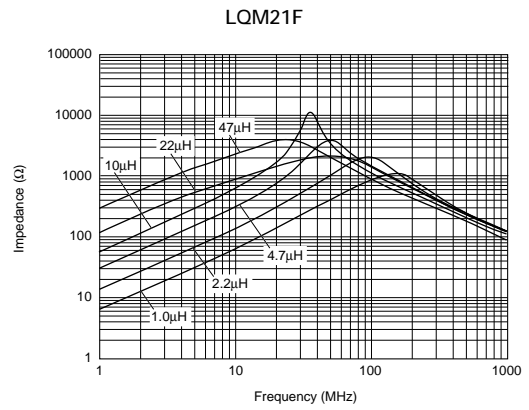
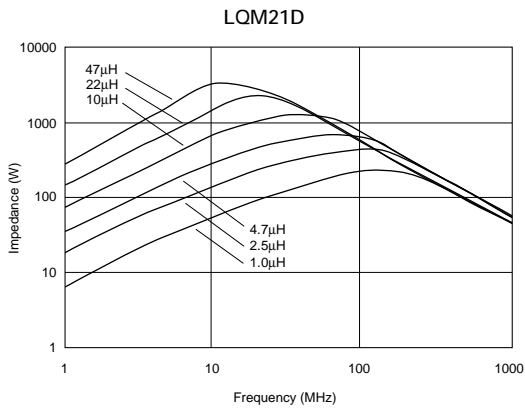

### Inductance-Current Characteristics

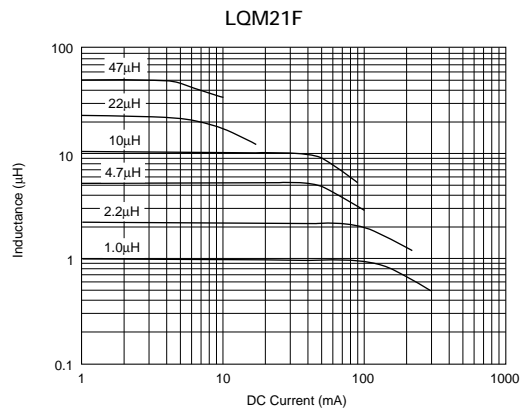

## LQM31F Series

LQM31F series consists of magnetically shielded chip coils based on Murata's technologies of multilayer process and magnetic materials. Excellent direct current characteristics and low DC resistance are realized by using magnetic materials which have excellent saturation characteristics and high permeability.

### ■ Features

1. LQM31F series is suitable for power line choke because of its excellent direct current characteristics and large rated current. (70mA at 10 micro H)
2. Low DC resistance is realized.
3. The cross talk characteristics are excellent because of magnetically shielded structure.
4. Low profile 1.0mm.
5. The series has excellent solder heat resistance. Both flow and reflow soldering can be employed.

### ■ Applications

Circuits for DC power line choke of telecommunication equipments such as PDA, Note-PC, digital camera, PDA, MD and DVD-RAM

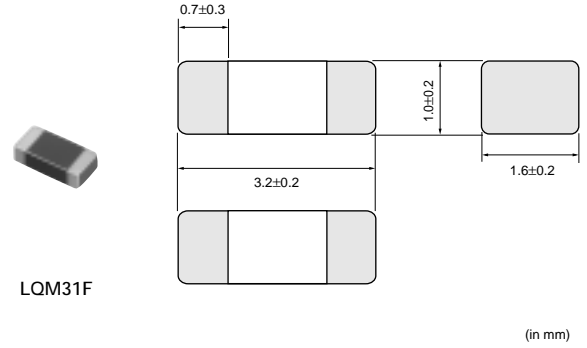

(in mm)

Part Number	Inductance (μH)	Rated Current (mA)	Max. of DC resistance (ohm)	Self Resonance Frequency (MHz)
LQM31FN100M00	10 ±20%	70	0.50	20 min.

Min. of Operating Temp. : -40°C to 85°C

### ■ Impedance-Frequency Characteristics

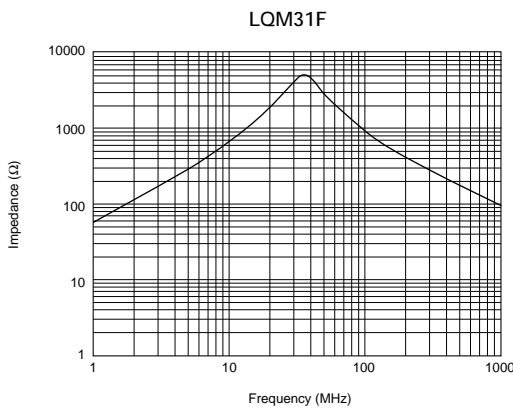

### ■ Inductance-Current Characteristics

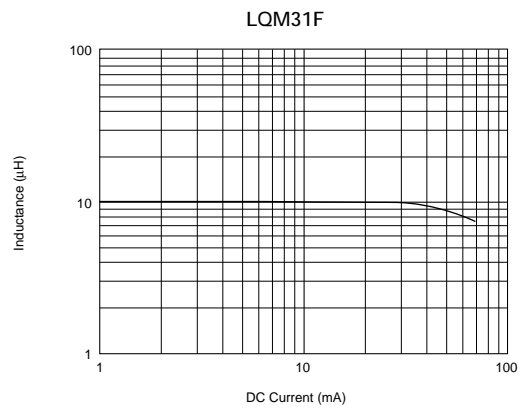

# CHIP COILS



## for Choke Winding Type LQH31C/LQH32C/LQH43C Series

### LQH31C Series

#### ■ Features

The LQH31C series consists of miniature chip inductors with low DC resistance, high current capacity, and high impedacne characteristics. It is suitable for use as choke coils in DC power supply circuits. high rated current up to 970mA is available.

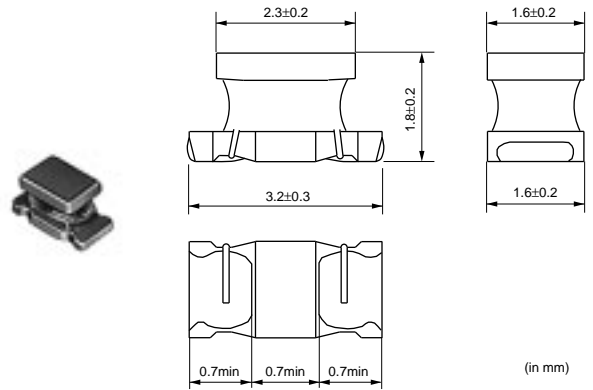

Part Number	Inductance (μH)	Rated Current (mA)	Max. of DC resistance (ohm)	Self Resonance Frequency (MHz)
LQH31CN100K01	10 ±10%	230	1.69	20 min.
LQH31CN220K01	22 ±10%	160	3.9	14 min.
LQH31CN470K01	47 ±10%	100	10.4	10 min.
LQH31CN101K01	100 ±10%	80	15.6	7 min.
LQH31CNR12M01	0.12 ±20%	970	0.112	250 min.
LQH31CNR22M01	0.22 ±20%	850	0.14	250 min.
LQH31CNR47M01	0.47 ±20%	700	0.21	180 min.
LQH31CN1R0M01	1 ±20%	510	0.364	100 min.
LQH31CN2R2M01	2.2 ±20%	430	0.533	50 min.
LQH31CN4R7M01	4.7 ±20%	340	0.845	31 min.

Min. of Operating Temp. : -25°C to 85°C

10

#### ■ Impedance-Frequency Characteristics

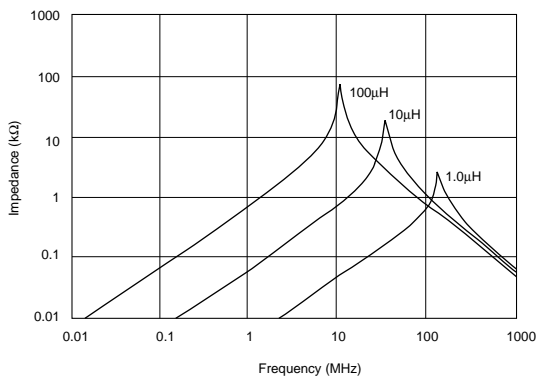

#### ■ Inductance-Current Characteristics

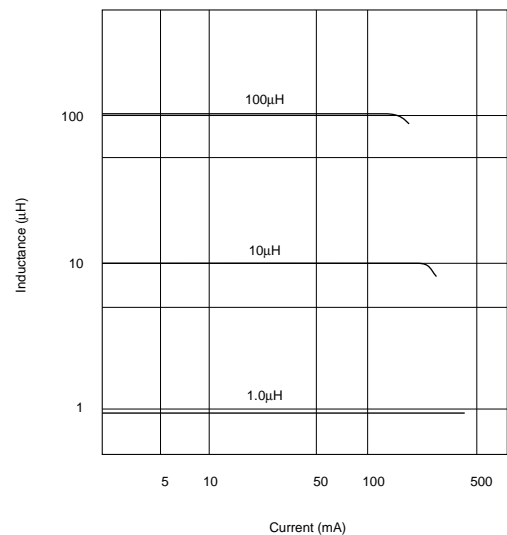

## LQH32C Series

The LQH32C series consists of miniature chip coils with low DC resistance, high current capacity, and high impedance characteristics.

These features are made possible by the development of Murata's innovative automatic winding techniques.

They are excellent for use as choke coils in DC power supply circuits.

### ■ Features

1. The low DC resistance means high current and high inductance.  
For inductance ranging from 0.15 micro H to 10 micro H, LQH32C coils have very low DC resistance.
2. The series exhibit low voltage drops and small variations in inductance with respect to temperature rise and DC current level. This makes them excellent for use as power supply line choke coils.
3. The series has excellent solder heat resistance. Both flow and reflow soldering methods can be employed.



LQH32C

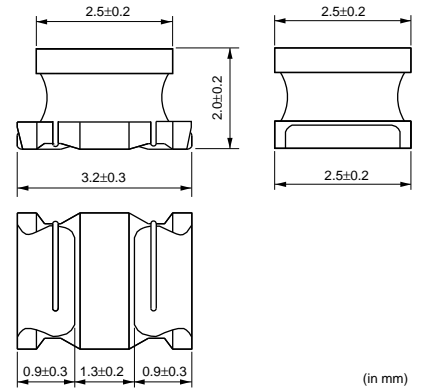

The LQH32CN\_51 series consists of miniature chip coils with low DC resistance, high current capacity, and high impedance characteristics.

These features are made possible by the development of Murata's innovative winding techniques. They are excellent for use as choke coils in DC power supply circuits.

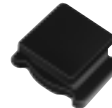

LQH32CN\_51

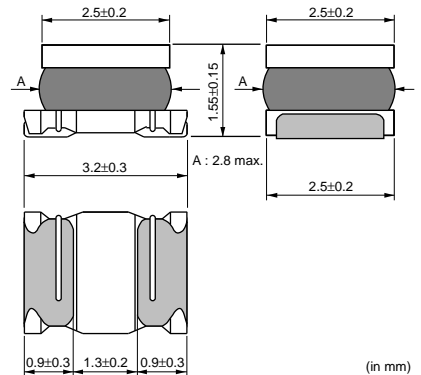

### ■ Features (LQH32CN\_51)

1. The series have a wide inductance range of 1.0 micro H to 100 micro H.
2. The series exhibit low voltage drops and small variations in inductance with respect to temperature rise and DC current level. This makes them excellent for use as power supply line choke coils.
3. The series has excellent solder heat resistance. Both flow and reflow soldering methods can be employed.

Part Number	Inductance (μH)	Rated Current (mA)	Max. of DC resistance (ohm)	Self Resonance Frequency (MHz)
LQH32CN100K11	10 ±10%	450	0.39	26 min.
LQH32CN100K21	10 ±10%	300	0.572	26 min.
LQH32CN100K51	10 ±10%	450	0.390	26 min.
LQH32CN150K51	15 ±10%	300	0.754	26 min.
LQH32CN220K21	22 ±10%	250	0.923	19 min.
LQH32CN220K51	22 ±10%	250	0.923	19 min.
LQH32CN330K51	33 ±10%	200	1.43	17 min.
LQH32CN470K21	47 ±10%	170	1.69	15 min.
LQH32CN470K51	47 ±10%	170	1.69	15 min.
LQH32CN680K51	68 ±10%	130	2.86	12 min.
LQH32CN101K21	100 ±10%	100	4.55	10 min.
LQH32CN101K51	100 ±10%	100	4.55	10 min.
LQH32CN221K21	220 ±10%	70	10.92	6.8 min.
LQH32CN331K21	330 ±10%	60	13	5.6 min.
LQH32CN391K21	390 ±10%	60	22.1	5 min.

Continued on the following page.

Continued from the preceding page.

Part Number	Inductance (μH)	Rated Current (mA)	Max. of DC resistance (ohm)	Self Resonance Frequency (MHz)
LQH32CN471K21	470 ±10%	60	24.7	5 min.
LQH32CN561K21	560 ±10%	60	28.6	5 min.
LQH32CNR15M11	0.15 ±20%	1450	0.036	400 min.
LQH32CNR27M11	0.27 ±20%	1250	0.044	250 min.
LQH32CNR47M11	0.47 ±20%	1100	0.055	150 min.
LQH32CN1R0M11	1 ±20%	1000	0.078	100 min.
LQH32CN1R0M21	1.0 ±20%	1000	0.078	26 min.
LQH32CN1R0M51	1.0 ±20%	1000	0.078	100 min.
LQH32CN2R2M11	2.2 ±20%	790	0.1261	64 min.
LQH32CN2R2M21	2.2 ±20%	600	0.169	64 min.
LQH32CN2R2M51	2.2 ±20%	790	0.126	64 min.
LQH32CN4R7M11	4.7 ±20%	650	0.195	43 min.
LQH32CN4R7M21	4.7 ±20%	450	0.26	43 min.
LQH32CN4R7M51	4.7 ±20%	650	0.195	43 min.

Min. of Operating Temp. : -25°C to 85°C

■ Impedance-Frequency Characteristics

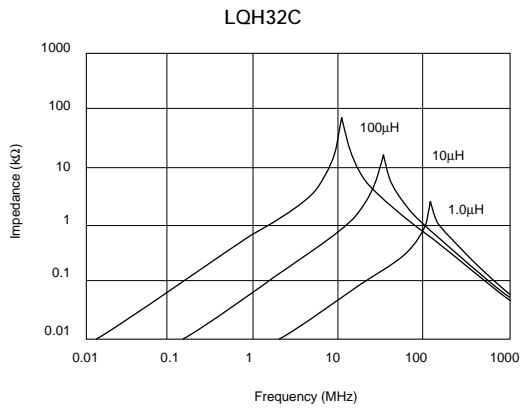

■ Inductance-Current Characteristics

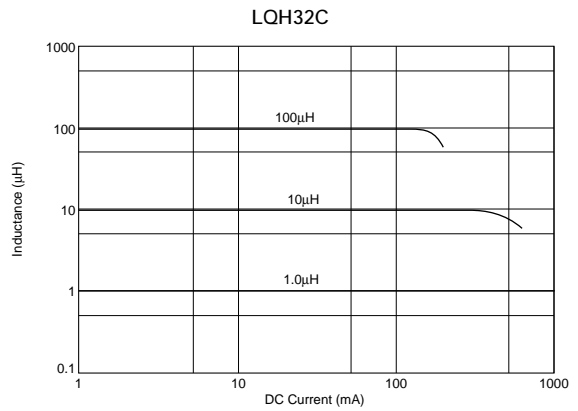

■ Impedance-Frequency Characteristics

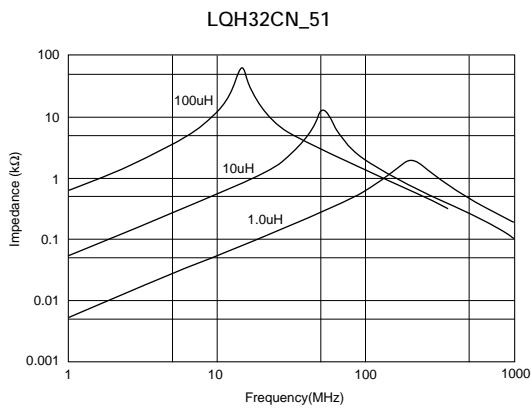

■ Inductance-Current Characteristics

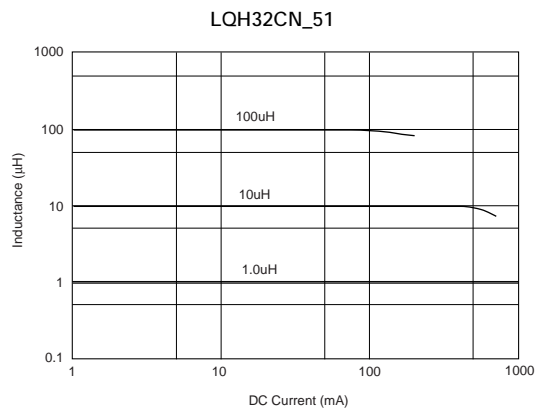

10

## LQH43C Series

The LQH43C series consists of miniature chip inductors with low DC resistance, high current capacity, and high impedance characteristics. It is suitable for use as choke coils in DC power supply circuits.

### ■ Features

1. The LQH43C series has an open magnetic structure. Various inductance range is available.
2. The series exhibits low voltage drops and small change in inductance with respect to temperature rise and DC current level. This makes them excellent to use as power supply line choke coils.
3. The LQH43C has miniature size 4.5mmx3.2mm and realized low height 2.8mm at max.
4. The series has excellent solder heat resistance. Both flow and reflow soldering methods can be employed.

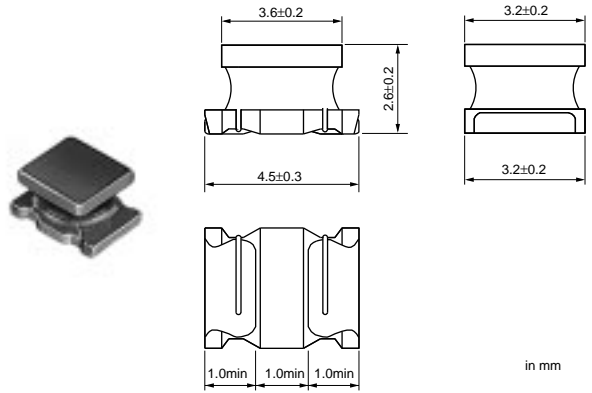

Part Number	Inductance (μH)	Rated Current (mA)	Max. of DC resistance (ohm)	Self Resonance Frequency (MHz)
LQH43CN100K01	10 ±10%	650	0.24	23
LQH43CN150K01	15 ±10%	570	0.32	20
LQH43CN220K01	22 ±10%	420	0.6	15
LQH43CN330K01	33 ±10%	310	1.0	12
LQH43CN470K01	47 ±10%	280	1.1	10
LQH43CN680K01	68 ±10%	220	1.7	8.4
LQH43CN101K01	100 ±10%	190	2.2	6.8
LQH43CN151K01	150 ±20%	130	3.5	5.5
LQH43CN221K01	220 ±10%	110	4.0	4.5
LQH43CN331K01	330 ±10%	100	6.8	3.6
LQH43CN471K01	470 ±10%	90	8.5	3.0
LQH43CN1R0M01	1.0 ±20%	1080	0.08	100
LQH43CN1R5M01	1.5 ±20%	1000	0.09	85
LQH43CN2R2M01	2.2 ±20%	900	0.11	60
LQH43CN3R3M01	3.3 ±20%	800	0.13	47
LQH43CN4R7M01	4.7 ±20%	750	0.15	35
LQH43CN6R8M01	6.8 ±20%	720	0.20	30

Min. of Operating Temp. : -25°C to 85°C

### ■ Impedance-Frequency Characteristics

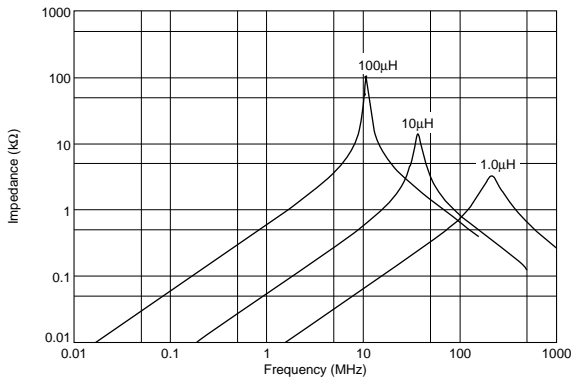

### ■ Inductance-Current Characteristics

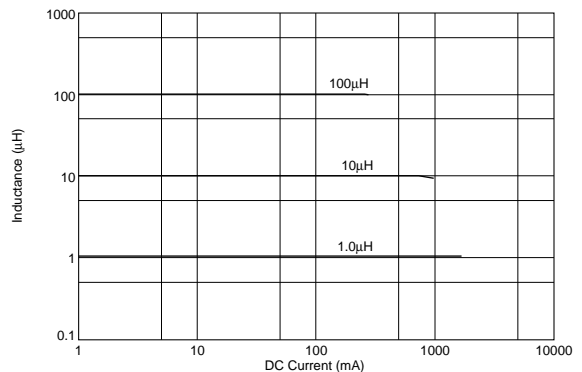

# CHIP COILS



## for Choke Magnetic Shielded Type LQH3KS Series

### LQH3KS Series

#### ■ Features

1. Low profile dimension (2.1mm max.) and small size of 1212 (3.3x3.3mm) is suitable for portable equipment.
2. The series have low DC Resistance.
3. LQH3KS series have large inductance of 560 micro H to 2200 micro H.
4. Magnetically shielded structure prevents interference occurring between peripheral components.

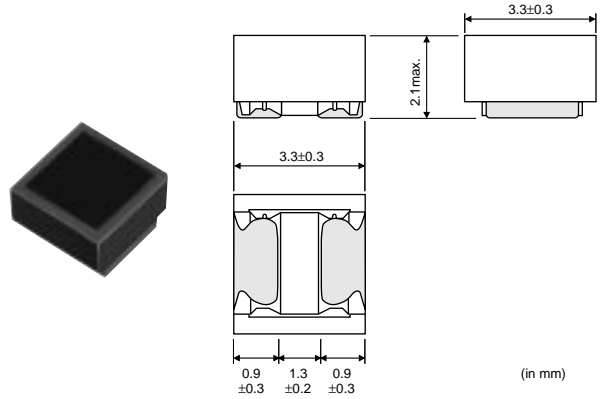

Part Number	Inductance (μH)	Rated Current (mA)	Max. of DC resistance (ohm)	Self Resonance Frequency (MHz)
LQH3KSN561N21	560 ±30%	50	10.14	3.0 min.
LQH3KSN681N21	680 ±30%	40	11.83	2.6 min.
LQH3KSN102N21	1000 ±30%	30	14.3	2.1 min.
LQH3KSN152N21	1500 ±30%	25	29.9	1.7 min.
LQH3KSN222N21	2200 ±30%	20	36.4	1.5 min.

Min. of Operating Temp. : -25°C to 85°C

#### ■ Impedance-Frequency Characteristics

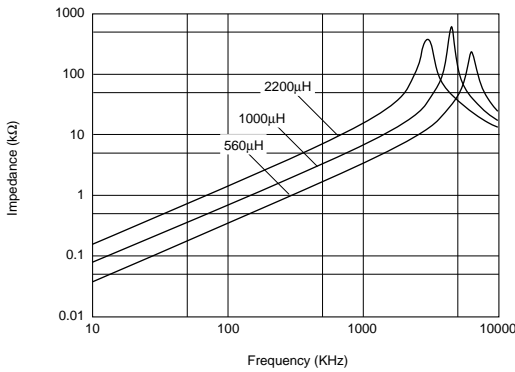

#### ■ Inductance-Current Characteristics

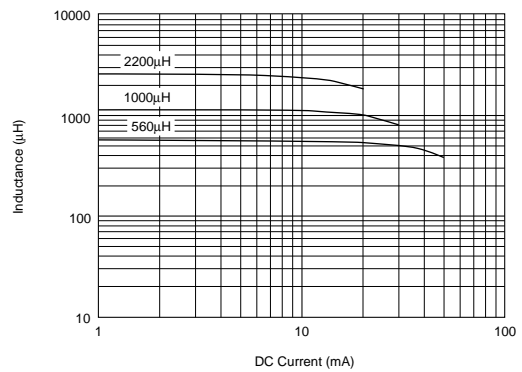

11

# CHIP COILS



## for Choke Winding/Magnetic Shielded Type LQH55D/LQH66S Series

### LQH55D Series

#### ■ Features

The LQH55D/LQH66S series are choke inductors which have achieved low direct current resistance, large current capacity and large inductance by using high performance thick wire wrapping technology. Because the LQH66S series has a shielded construction, it can be mounted in high density without interference occurring between peripheral components. They are optimum for use as choke inductors in DC/DC converters and DC power supply circuits.

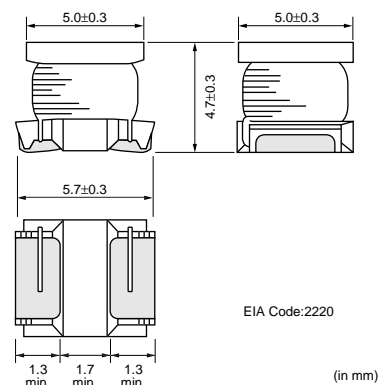

Part Number	Inductance (μH)	Rated Current (mA)	Max. of DC resistance (ohm)	Self Resonance Frequency (MHz)
LQH55DNR12M01	0.12 ±20%	6000	0.0098	450 min.
LQH55DNR27M01	0.27 ±20%	5300	0.014	300 min.
LQH55DNR47M01	0.47 ±20%	4800	0.0182	200 min.
LQH55DN1R0M01	1.0 ±20%	4000	0.027	150 min.
LQH55DN1R5M01	1.5 ±20%	3700	0.031	110 min.
LQH55DN2R2M01	2.2 ±20%	3200	0.041	80 min.
LQH55DN3R3M01	3.3 ±20%	2900	0.05	40 min.
LQH55DN4R7M01	4.7 ±20%	2700	0.0574	30 min.
LQH55DN6R8M01	6.8 ±20%	2000	0.104	25 min.
LQH55DN100M01	10 ±20%	1700	0.130	20 min.
LQH55DN150M01	15 ±20%	1400	0.21	17 min.
LQH55DN220M01	22 ±20%	1200	0.266	15 min.
LQH55DN330M01	33 ±20%	900	0.448	12 min.
LQH55DN470M01	47 ±20%	800	0.56	10 min.
LQH55DN680M01	68 ±20%	640	0.938	7.6 min.
LQH55DN101M01	100 ±20%	560	1.204	6.5 min.
LQH55DN151M01	150 ±20%	420	2.660	5.0 min.
LQH55DN221M01	220 ±20%	320	3.36	4.0 min.
LQH55DN331M01	330 ±20%	270	6.16	3.1 min.
LQH55DN471M01	470 ±20%	240	7.56	2.4 min.
LQH55DN681M01	680 ±20%	190	11.34	1.9 min.
LQH55DN102M01	1000 ±20%	150	14.42	1.7 min.
LQH55DN222M01	2200 ±20%	100	30.1	1.2 min.
LQH55DN472M01	4700 ±20%	70	61.04	0.8 min.
LQH55DN103M01	10000 ±20%	50	140	0.5 min.

Min. of Operating Temp. : -25°C to 80°C

### ■ Impedance-Frequency Characteristics

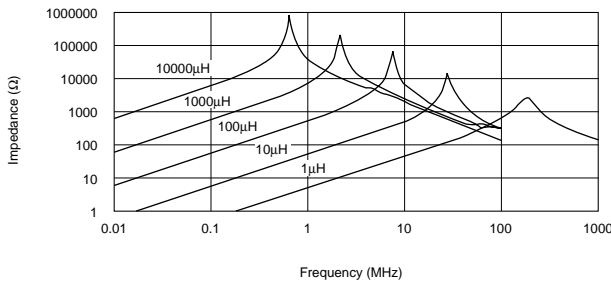

### ■ Inductance-Current Characteristics

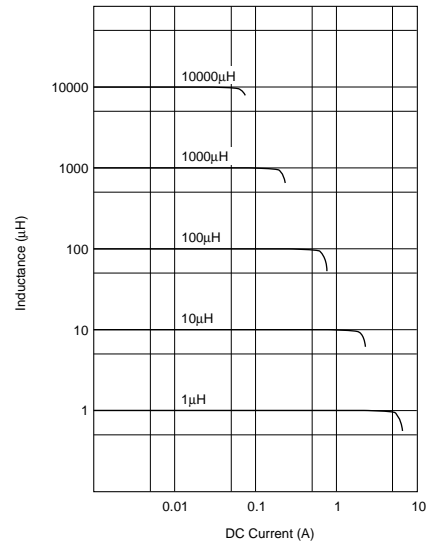

## LQH66S Series

### ■ Features

The LQH55D/LQH66S series are choke inductors which have achieved low direct current resistance, large current capacity and large inductance by using high performance thick wire wrapping technology. Because the LQH66S series has a shielded construction, it can be mounted in high density without interference occurring between peripheral components. They are optimum for use as choke inductors in DC/DC converters and DC power supply circuits.

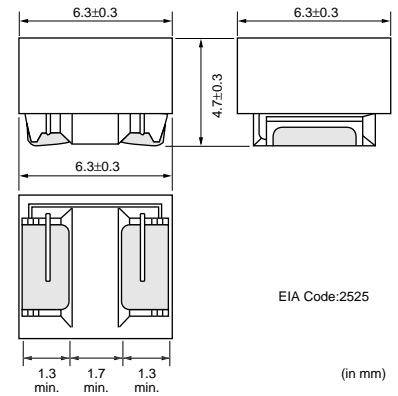

Part Number	Inductance (μH)	Rated Current (mA)	Max. of DC resistance (ohm)	Self Resonance Frequency (MHz)
LQH66SNR27M01	0.27 ±20%	6000	0.0098	300 min.
LQH66SNR68M01	0.68 ±20%	5300	0.014	180 min.
LQH66SN1R0M01	1.0 ±20%	4700	0.018	150 min.
LQH66SN1R5M01	1.5 ±20%	3800	0.022	110 min.
LQH66SN2R2M01	2.2 ±20%	3300	0.027	80 min.
LQH66SN3R3M01	3.3 ±20%	2600	0.031	40 min.
LQH66SN4R7M01	4.7 ±20%	2200	0.035	30 min.
LQH66SN6R8M01	6.8 ±20%	1800	0.0406	25 min.
LQH66SN100M01	10 ±20%	1600	0.050	20 min.
LQH66SN150M01	15 ±20%	1300	0.967	17 min.
LQH66SN220M01	22 ±20%	1100	0.122	15 min.
LQH66SN330M01	33 ±20%	860	0.196	12 min.
LQH66SN470M01	47 ±20%	760	0.238	10 min.
LQH66SN680M01	68 ±20%	600	0.406	7.6 min.
LQH66SN101M01	100 ±20%	520	0.504	6.5 min.
LQH66SN151M01	150 ±20%	420	0.882	5.0 min.
LQH66SN221M01	220 ±20%	350	1.106	4.0 min.
LQH66SN331M01	330 ±20%	280	2.52	3.2 min.
LQH66SN471M01	470 ±20%	240	3.08	2.5 min.
LQH66SN681M01	680 ±20%	200	5.46	2.0 min.
LQH66SN102M01	1000 ±20%	160	6.86	1.7 min.
LQH66SN222M01	2200 ±20%	100	13.16	1.2 min.
LQH66SN472M01	4700 ±20%	70	27.3	0.8 min.

Continued on the following page. ↗

Continued from the preceding page.

Part Number	Inductance ( $\mu\text{H}$ )	Rated Current (mA)	Max. of DC resistance (ohm)	Self Resonance Frequency (MHz)
<b>LQH66SN103M01</b>	10000 $\pm$ 20%	50	55.58	0.5 min.

Min. of Operating Temp. : -25°C to 80°C

### ■ Impedance-Frequency Characteristics

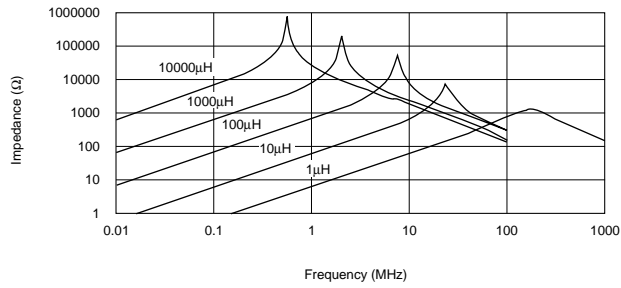

### ■ Inductance-Current Characteristics

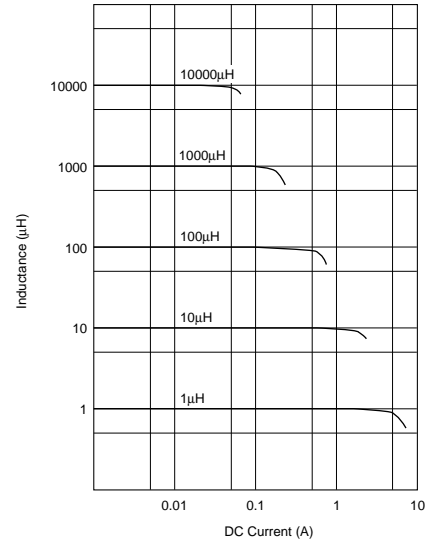

# Monolithic And Film Type Notice(Soldering and Mounting)

## 1. STANDARD LAND DIMENSIONS

A high Q value is achieved when the PCB electrode land pattern is designed so that it does not project beyond the chip coil electrode.

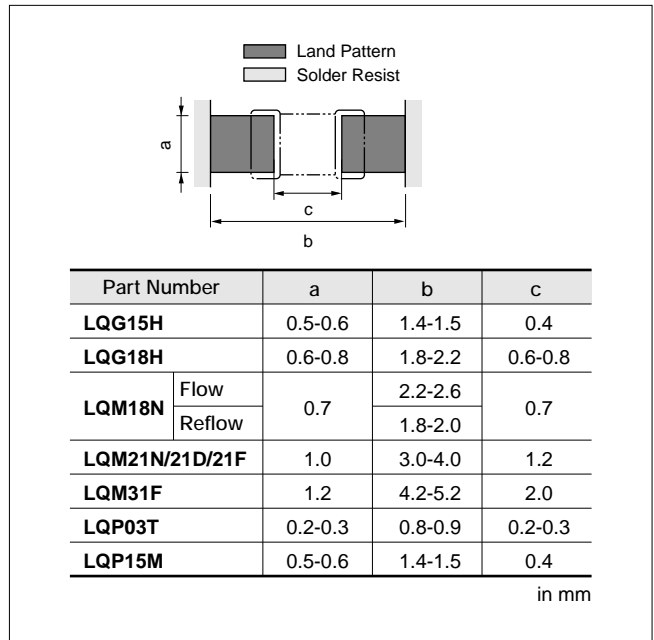

## 2. STANDARD SOLDERING CONDITIONS

### 1) Soldering method

Chip coils can be flow or reflow soldered. Please contact Murata regarding other soldering methods. The volume of solder can cause minor fluctuations in inductance value. Therefore, carefully control the amount of solder when soldering the LQG15H/18H, LQP03T and LQP15M series.

### 2) Soldering Temperature and Time

Solder within the temperature and time combinations indicated by the slanted lines in the following graphs. If soldering is repeated, please note that the allowed time is the accumulated time.

Solder : Use H60A,H63A(JIS Z 3282) or equivalent.

Use solder paste equivalent to H60A for LQP03T/15M and LQG15H/18H.

Flux : Use rosin-based flux, but not strongly acidic flux. (with chlorine content exceeding 0.2wt%)  
Do not use water-soluble flux.

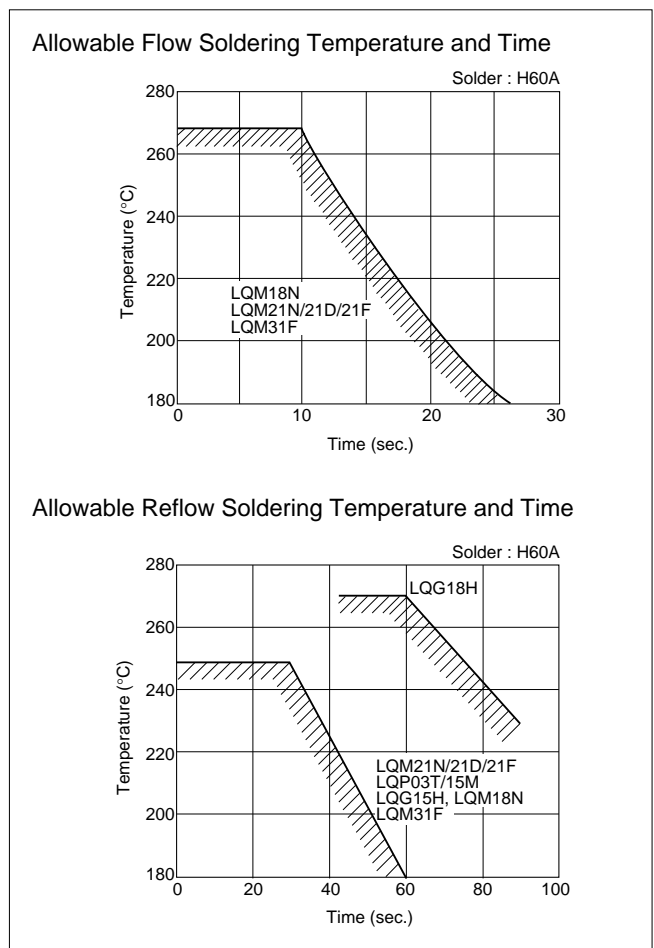

Continued on the following page.

## Monolithic And Film Type Notice(Soldering and Mounting)

Continued from the preceding page.

### 3) Standard Soldering Conditions

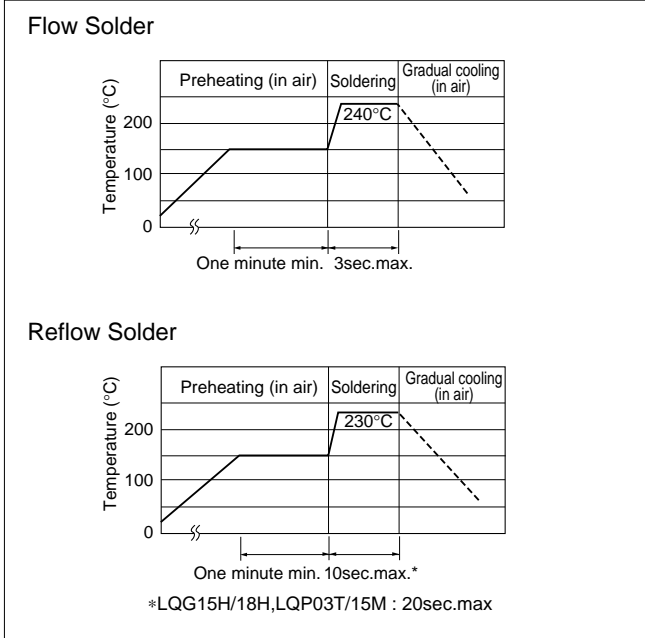

### 4) Reworking with Soldering Iron

Preheating at 150°C for 1 minute is required. Do not directly touch the ceramic element with the tip of the soldering iron. The reworking soldering conditions are as follows.

- Soldering iron power output : 30W Max.
- Temperature of soldering iron tip : 280°C
- Diameter of soldering iron end : 3.0mm Max.
- Soldering time : within 3 second

### 3. MOUNTING INSTRUCTIONS

#### 1) Land Pattern Dimensions

Large lands reduce Q of the mounted chip. Also, large protruding land areas (bordered by lines having dimensions 'c' and 'd' shown below) cause floating and electrode cracks.

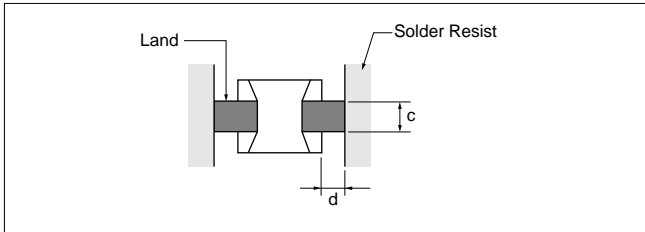

#### 2) Magnetic Coupling

Since some chip coils are constructed like an open magnetic circuit, narrow spacing between coils may cause magnetic coupling. The LQG and LQM series have a magnetically shielded structure. The structure makes their coupling coefficient smaller than that of conventional chip coils.

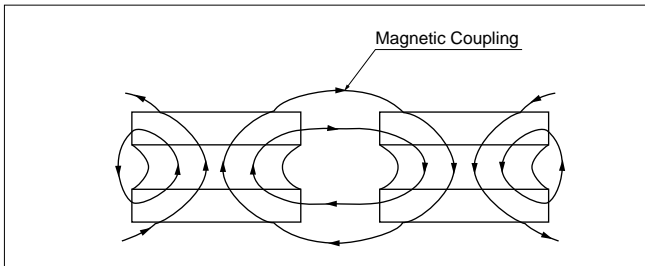

Continued on the following page.

## Monolithic And Film Type Notice(Soldering and Mounting)

Continued from the preceding page.

### 3) PCB Warping

Arrange chip coils to minimize stress caused by PCB warping.

The arrangement shown in Fig.2 is more effective in preventing stress than that shown in Fig.1.

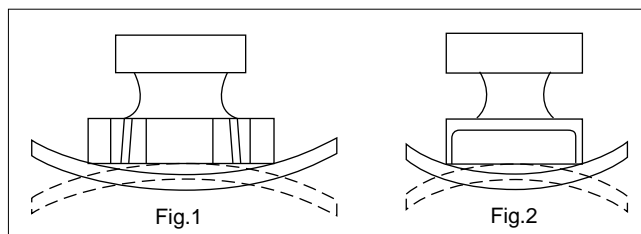

### 4) Amount of Solder Paste

Excessive solder causes electrode corrosion, while insufficient solder causes low electrode bonding strength. Adjust the amount of solder paste so that solder is applied as shown in the right.

Standard thickness of solder paste : 100 to 150 $\mu$ m

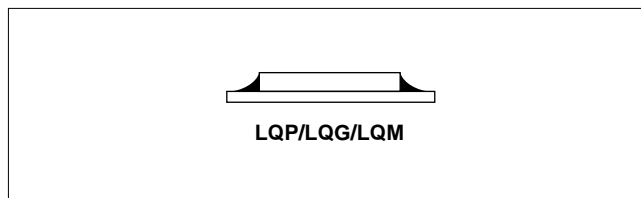

### 5) Amount of Adhesive

If too much adhesive is applied, then it may overflow into the land or termination areas and yield poor solderability. In contrast, if insufficient adhesive is applied, or if the adhesive is not sufficiently hardened, then the chip may become detached during flow soldering. Apply the adhesive in accordance with the following conditions.

Part Number	Typical Application Amount (in:mg)		
	MR-8153RA	NF-3000	UVS-50R-2
<b>LQM18N</b>	0.05-0.06	0.06-0.07	0.06-0.07
<b>LQM21N/21D/21F</b>	0.15-0.20	0.20-0.25	0.20-0.25
<b>LQM31F</b>	0.20-0.25	0.25-0.30	0.25-0.30

## Winding Type Notice(Soldering and Mounting)

### 1. STANDARD LAND DIMENSIONS

A high Q value is achieved when the PCB electrode land pattern is designed so that it does not project beyond the chip coil electrode.

2.5min.\*      \* 2.0 min. (LQW15A/18A)

Part Number	a	b	c	d
<b>LQH31M/31C/31H</b>	1.5	4.5	1.75	1.0
<b>LQW31H</b>				
<b>LQW2BH</b>	1.2	3.0	1.1	0.8
<b>LQW18A</b>	0.7-1.0	1.8-2.0	0.6-0.7	0.6-0.8
<b>LQW15A</b>	0.65	1.2	0.35	0.50

in mm

If mounted at 2.5 (2.0) mm intervals as indicated in the diagram, attention should be paid to potential magnetic coupling effects when using the coil as a resonator.

**LQH43M**

**LQH43N**

**LQH43C**

in mm

Continued on the following page.

## Winding Type Notice(Soldering and Mounting)

 Continued from the preceding page.

### 2. STANDARD SOLDERING CONDITIONS

#### 1) Soldering method

Chip coils can be flow or reflow soldered.  
 Please contact Murata regarding other soldering methods.  
 Reflow soldering should be applied for LQW15A/18A.

#### 2) Soldering Temperature and Time

Solder within the temperature and time combinations indicated by the slanted lines in the following graphs. If soldering is repeated, please note that the allowed time is the accumulated time.

Solder : Use H60A,H63A(JIS Z 3282) or equivalent.

Flux : Use rosin-based flux, but not strongly acidic flux.  
 (with chlorine content exceeding 0.2wt%)  
 Do not use water-soluble flux.

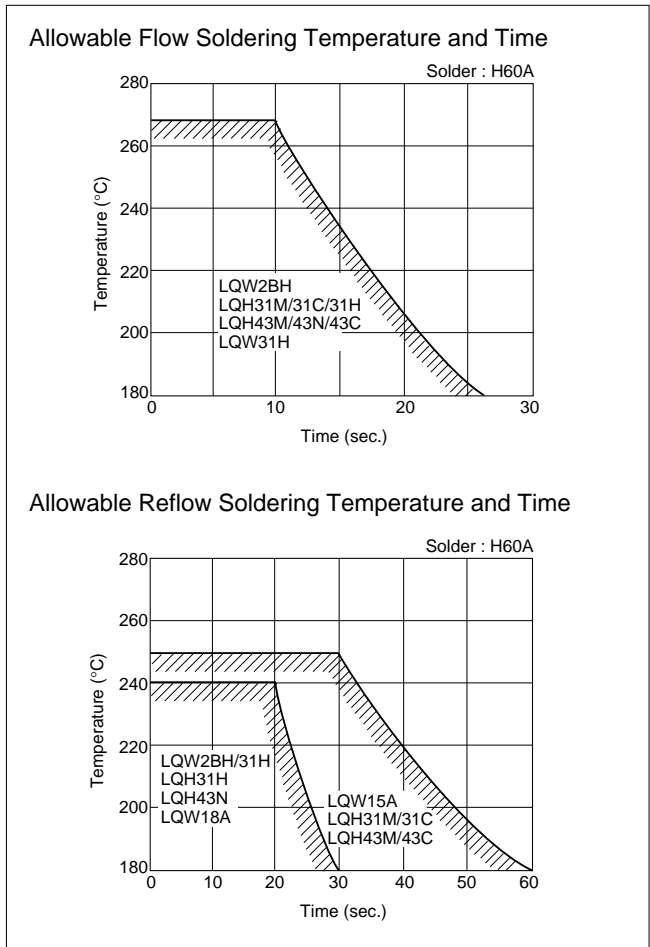

#### 3) Standard Soldering Conditions

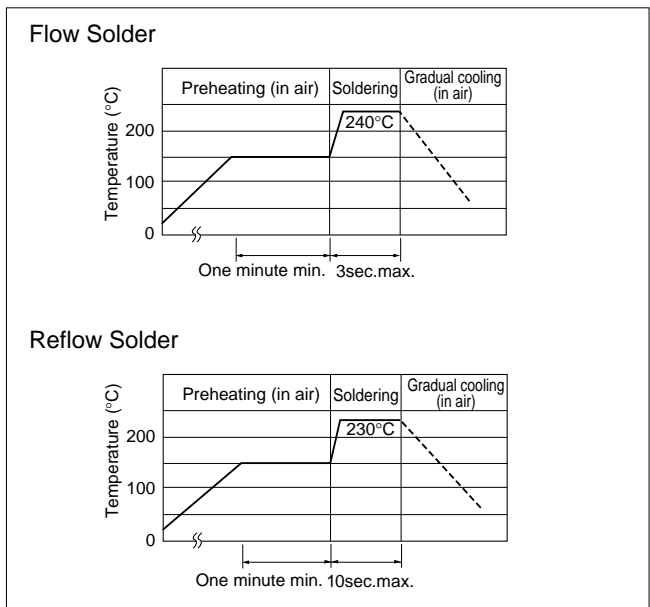

Continued on the following page. 

## Winding Type Notice(Soldering and Mounting)

 Continued from the preceding page.

### 4) Reworking with Soldering Iron

Preheating at 150°C for 1 minute is required. Do not directly touch the ceramic element with the tip of the soldering iron. The reworking soldering conditions are as follows.

- Soldering iron power output : 30W Max.
- Temperature of soldering iron tip : 280°C
- Diameter of soldering iron end : 3.0mm Max.
- Soldering time : within 3 second

### 3. MOUNTING INSTRUCTIONS

#### 1) Land Pattern Dimensions

Large lands reduce Q of the mounted chip. Also, large protruding land areas (bordered by lines having dimensions 'c' and 'd' shown below) cause floating and electrode cracks.

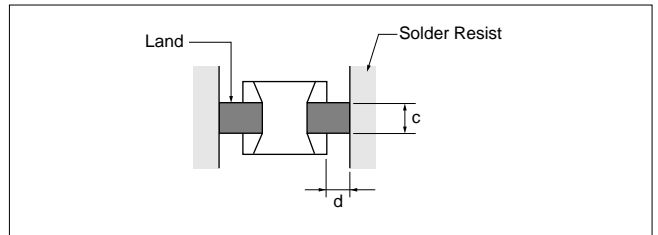

#### 2) Magnetic Coupling

Since some chip coils are constructed like an open magnetic circuit, narrow spacing between coils may cause magnetic coupling. The LQH series have a magnetically shielded structure. The structure makes their coupling coefficient smaller than that of conventional chip coils.

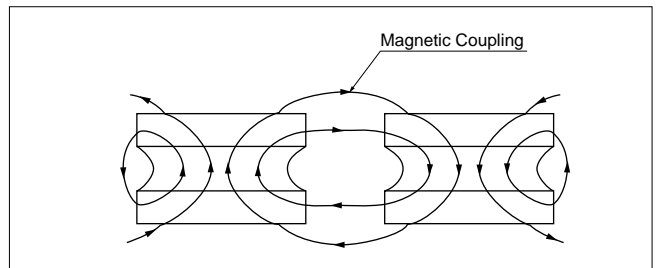

#### 3) PCB Warping

Arrange chip coils to minimize stress caused by PCB warping. The arrangement shown in Fig.2 is more effective in preventing stress than that shown in Fig.1.

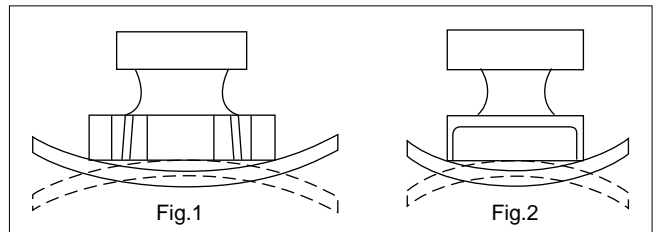

#### 4) Amount of Solder Paste

Excessive solder causes electrode corrosion, while insufficient solder causes low electrode bonding strength. Adjust the amount of solder paste so that solder is applied as shown in the right. Standard thickness of solder paste: 200µm to 300µm (LQW15A/18A : 100 to 150µm)

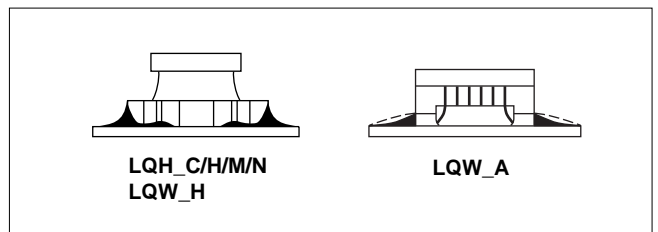

Continued on the following page. 

## Winding Type Notice(Soldering and Mounting)

 Continued from the preceding page.

### 5) Amount of Adhesive

If too much adhesive is applied, then it may overflow into the land or termination areas and yield poor solderability. In contrast, if insufficient adhesive is applied, or if the adhesive is not sufficiently hardened, then the chip may become detached during flow soldering. Apply the adhesive in accordance with the following conditions.

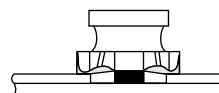

Part Number	Typical Application Amount (in:mg)		
	MR-8153RA	NF-3000	UVS-50R-2
<b>LQW2BH</b>	0.16-0.18	0.20-0.25	0.21-0.23
<b>LQH31M/31C/31H</b> <b>LQW31H</b>	0.18-0.20	0.20-0.25	0.20-0.25
<b>LQH43M(N)</b> <b>LQH43C</b>	0.45-0.50	0.60-0.80	0.60-0.80

# Winding And Mgnetic Shielded Type Notice(Soldering and Mounting)

## 1. STANDARD LAND DIMENSIONS

A high Q value is achieved when the PCB electrode land pattern is designed so that it does not project beyond the chip coil electrode.

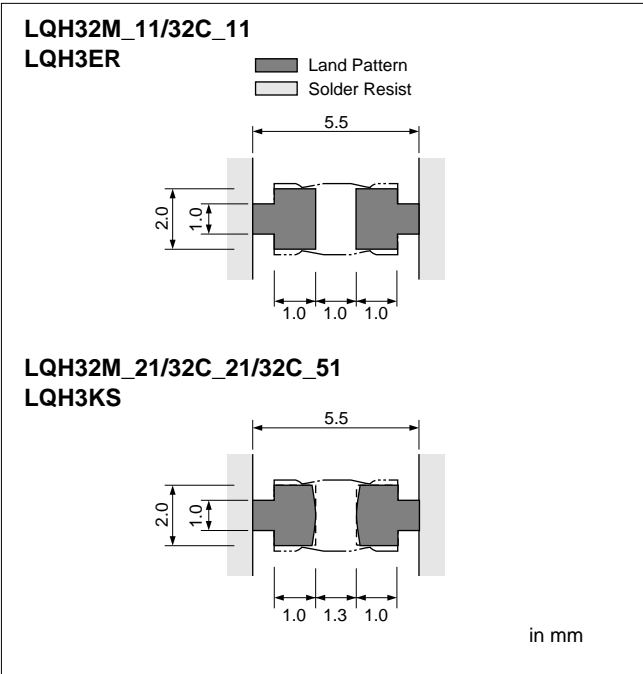

## 2. STANDARD SOLDERING CONDITIONS

### 1) Soldering method

Chip coils can be flow or reflow soldered.  
Please contact Murata regarding other soldering methods.  
Reflow soldering should be applied for LQH3ER/3KS.

### 2) Soldering Temperature and Time

Solder within the temperature and time combinations indicated by the slanted lines in the following graphs. If soldering is repeated, please note that the allowed time is the accumulated time.

Solder : Use H60A,H63A(JIS Z 3282) or equivalent.  
Flux : Use rosin-based flux, but not strongly acidic flux.  
(with chlorine content exceeding 0.2wt%)  
Do not use water-soluble flux.

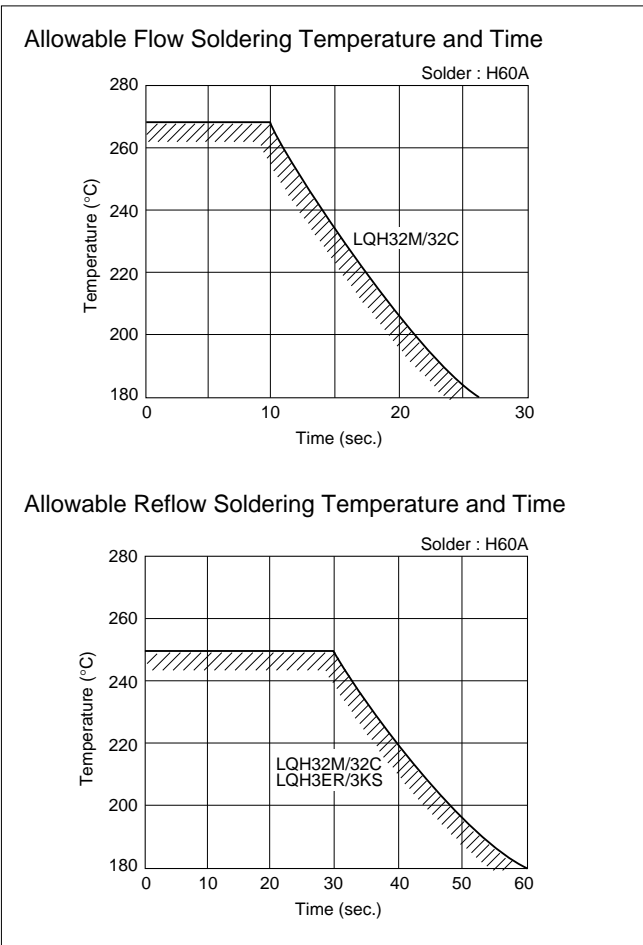

Continued on the following page.

## Winding And Mgnetic Shielded Type Notice(Soldering and Mounting)

Continued from the preceding page.

### 3) Standard Soldering Conditions

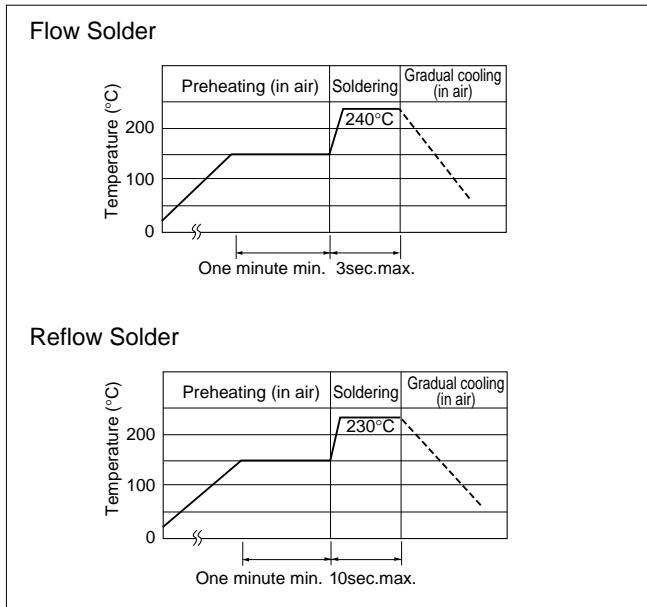

### 4) Reworking with Soldering Iron

Preheating at 150°C for 1 minute is required. Do not directry touch the ceramic element with the tip of the soldering iron. The reworking soldering conditions are as follows.

- Soldering iron power output : 30W Max.
- Temperature of soldering iron tip : 280°C
- Diameter of soldering iron end : 3.0mm Max.
- Soldering time : within 3 second

### 3. MOUNTING INSTRUCTIONS

#### 1) Land Pattern Dimensions

Large lands reduce Q of the mounted chip. Also, large protruding land areas (bordered by lines having dimensions 'c' and 'd' shown bellow) cause floating and electrode cracks.

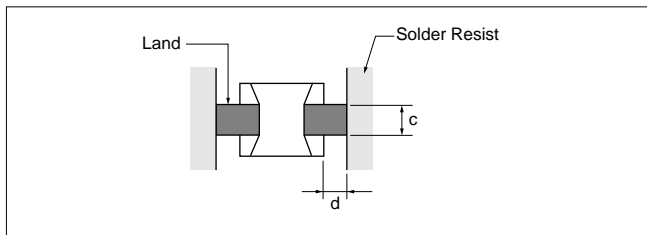

#### 2) Magnetic Coupling

Since some chip coils are constructed like an open magnetic circuit, narrow spacing between coils may cause magnetic coupling.

The LQH\_R/S series have a magnetically shielded structure. The structure makes their coupling coefficient smaller than that of conventional chip coils. In particular, the LQH3ER series has a very small coupling coefficient.

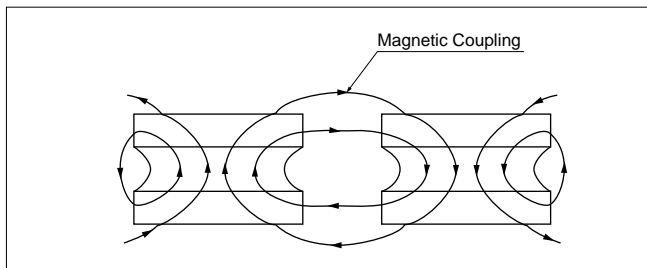

Continued on the following page.

## Winding And Mgnetic Shielded Type Notice(Soldering and Mounting)

 Continued from the preceding page.

### 3) PCB Warping

Arrange chip coils to minimize stress caused by PCB warping.

The arrangement shown in Fig.2 is more effective in preventing stress than that shown in Fig.1.

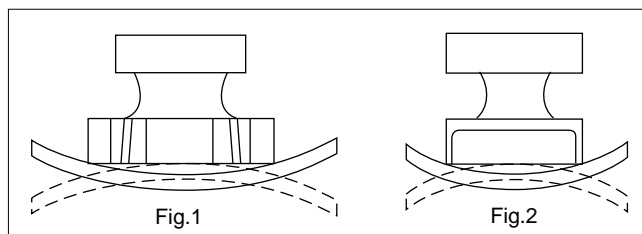

### 4) Amount of Solder Paste

Excessive solder causes electrode corrosion, while insufficient solder causes low electrode bonding strength. Adjust the amount of solder paste so that solder is applied as shown in the right.

Standard thickness of solder paste: 200μm to 300μm

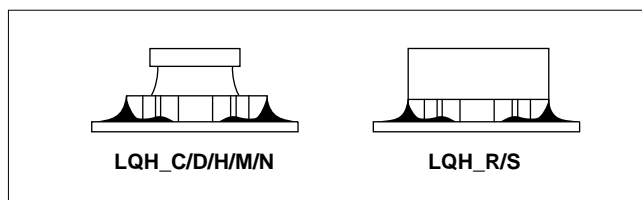

### 5) Amount of Adhesive

If too much adhesive is applied, then it may overflow into the land or termination areas and yield poor solderability. In contrast, if insufficient adhesive is applied, or if the adhesive is not sufficiently hardened, then the chip may become detached during flow soldering. Apply the adhesive in accordance with the following conditions.

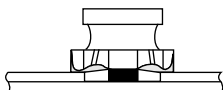

Part Number	Typical Application Amount (in:mg)		
	MR-8153RA	NF-3000	UVS-50R-2
<b>LQH32M/32C</b>	0.20-0.23	0.27-0.35	0.27-0.35

## Large-current Type Notice(Soldering and Mounting)

### 1. STANDARD LAND DIMENSIONS

A high Q value is achieved when the PCB electrode land pattern is designed so that it does not project beyond the chip coil electrode.

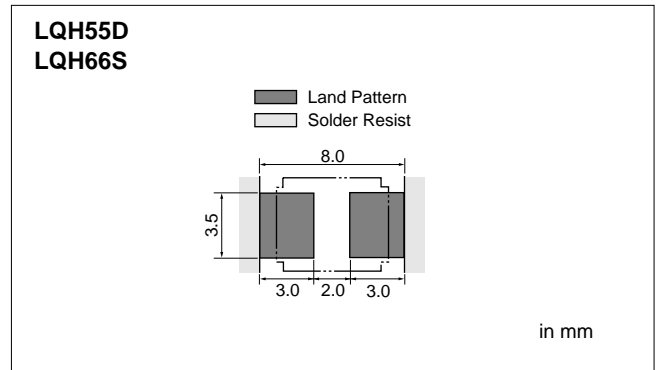

### 2. STANDARD SOLDERING CONDITIONS

#### 1) Soldering method

Reflow soldering should be applied for LQH55D/66S.

#### 2) Soldering Temperature and Time

Solder within the temperature and time combinations indicated by the slanted lines in the following graphs. If soldering is repeated, please note that the allowed time is the accumulated time.

Solder : Use H60A,H63A(JIS Z 3282) or equivalent.

Flux : Use rosin-based flux, but not strongly acidic flux.  
(with chlorine content exceeding 0.2wt%)  
Do not use water-soluble flux.

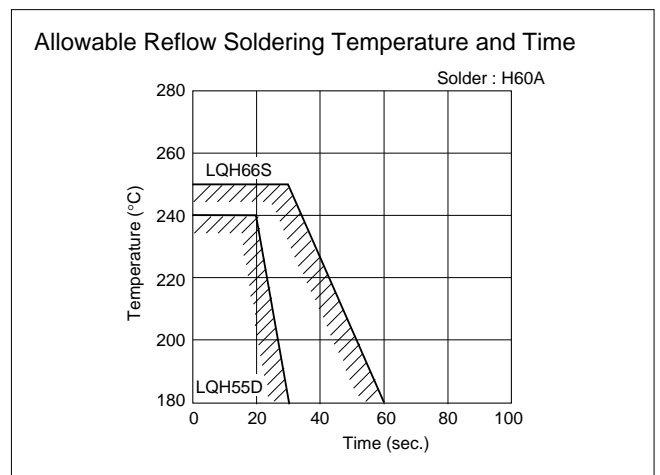

#### 3) Standard Soldering Conditions

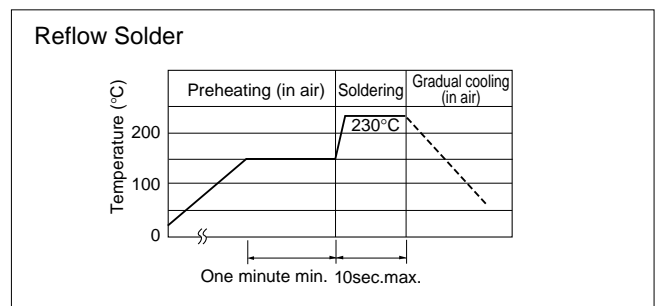

#### 4) Reworking with Soldering Iron

Preheating at 150°C for 1 minute is required. Do not directly touch the ceramic element with the tip of the soldering iron. The reworking soldering conditions are as follows.

- Soldering iron power output : 30W Max.
- Temperature of soldering iron tip : 280°C
- Diameter of soldering iron end : 3.0mm Max.
- Soldering time : within 3 second

Continued on the following page.

## Large-current Type Notice(Soldering and Mounting)

 Continued from the preceding page.

### 3. MOUNTING INSTRUCTIONS

#### 1) Land Pattern Dimensions

Large lands reduce Q of the mounted chip. Also, large protruding land areas (bordered by lines having dimensions 'c' and 'd' shown bellow) cause floating and electrode cracks.

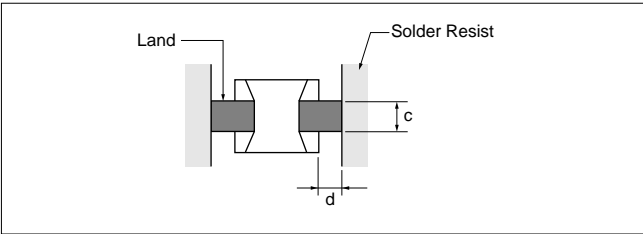

#### 2) Magnetic Coupling

Since some chip coils are constructed like an open magnetic circuit, narrow spacing between coils may cause magnetic coupling. The LQH\_S series have a magnetically shielded structure. The structure makes their coupling coefficient smaller than that of conventional chip coils.

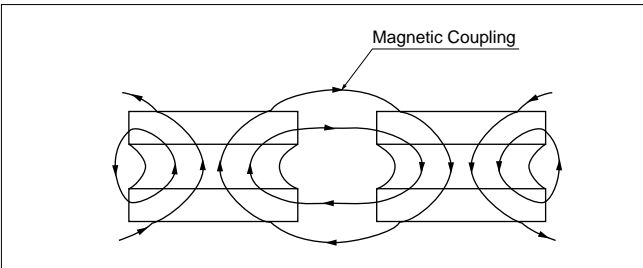

#### 3) PCB Warping

Arrange chip coils to minimize stress caused by PCB warping. The arrangement shown in Fig.2 is more effective in preventing stress than that shown in Fig.1.

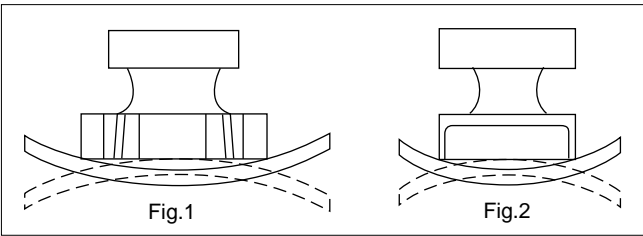

#### 4) Amount of Solder Paste

Excessive solder causes electrode corrosion, while insufficient solder causes low electrode bonding strength. Adjust the amount of solder paste so that solder is applied as shown bellow  
Standard thickness of solder paste: 200μm to 300μm

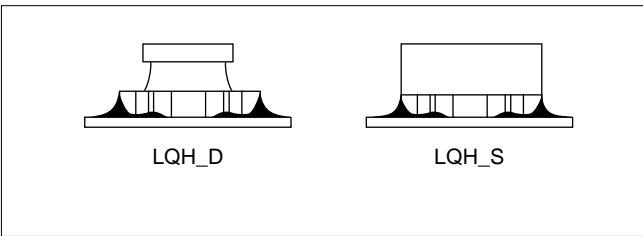

# Notice

## ■ Notice (Storage and Operating Conditions)

### < OPERATING ENVIRONMENT >

Do not use products in chemical atmosphere such as chlorine gas, acid or sulfide gas.

### < STORAGE REQUIREMENTS >

#### 1. Storage Period

Products should be used within 12 months reckon from the date of our out-going inspection.

Solderability should be verified if this period is exceeded. (LQH3ER/3KS series should be used within 6 months.)

#### 2. Storage conditions

- a) Store products in a warehouse in compliance with the following conditions :  
Temperature : -10 to 40C.

Humidity : 30 to 70% (relative humidity)

Do not subject products to rapid changes in temperature and humidity.

Do not store them in chemical atmosphere such as one containing sulfurous acid gas or alkaline gas.

This will prevent electrode oxidation which causes poor solderability and possible corrosion of coils.

- b) Do not store products in bulk packaging to prevent collision among coils which causes core chipping and wire breakage.
- c) Store products on pallets to protect from humidity, dust, etc.
- d) Avoid heat shock, vibration, direct sunlight, etc.

## ■ Notice (Soldering and Mounting)

### < CLEANING >

The following conditions should be observed when cleaning chip coils.

- 1. Cleaning Temperature : 60C. max. (40C. max. for CFC alternatives and alcohol cleaning agents)

#### 2. Ultrasonic

Output : 20W/l max.

Duration : 5 minutes max.

Frequency : 28kHz to 40kHz

Care should be taken not to cause resonance of the PCB and mounted products.

#### 3. Cleaning agent

The following cleaning agents have been tested on individual components. Evaluation in complete assembly should be done prior to production.

- a) CFC alternatives and alcohol cleaning agents
  - Isopropyl alcohol ( IPA )

- HCFC-225

#### b) Aqueous cleaning agents

- Surface active agent ( Clean Thru 750H )
  - High grade alcohol ( Pine Alpha ST-100S )
  - Hydrocarbon ( Techno Cleaner 335 )
  - Alkaline Saponifier ( Aqua Cleaner 240 -cleaner should be diluted to 20% using deionized water. )
- LQH\_R/S series : Aqueous agents should not be used because they may cause quality deterioration.  
LQH series : Surface active agent and high grade alcohol can be used.

#### 4. Ensure that flux residue is completely removed.

Component should be thoroughly dried after aqueous agents have been removed with deionized water. For additional cleaning methods, please contact Murata.

## Notice

### ■ Notice (Handling)

This item is designed to have sufficient strength, but handle with care not to make it chipped or broken due to its ceramic structure.

#### LQW\_A series

- Sharp material, such as tweezers, shall not touch to the winding portion to prevent the breaking of wire.
- Do not give excessive Mechanical shock should not be applied to the products mounted on the board to prevent the breaking of the core.
- In some mounting machines, when picking up components, support pin pushes up the components from the bottom of base tape. In this case, please remove the support pin. The support pin may damage the components and break wire.

#### LQH\_C/D/H/M/N, LQW\_H series

- Sharp material, such as tweezers, shall not touch to the winding portion to prevent the breaking of wire.
- Do not give excessive Mechanical shock should not be applied to the products mounted on the board to prevent the breaking of the core.

#### LQP series

- The pattern of the chip coil is covered with the protection film. But the handling the chip coil shall be taken care so that the chip coil would not be damaged with the pick-up nozzle, the sharp

substance and so on.

#### LQM series

- There is possibility that the inductance value change due to magnetism. Do not use a magnet or tweezers with magnetism when chip coil are handled. ( The tip of the tweezers should be molded with resin or pottery.)

#### < HANDLING >

1. Avoid applying excessive stress to products to prevent damage.
2. Do not touch winding with sharp objects such as tweezers to prevent wire breakage.
3. Do not apply excessive force to products mounted on boards to prevent core breakage.

#### < TRANSPORTATIONS >

Do not apply excessive vibration or mechanical shock to products.

#### < RESIN COATING >

When coating products with resin, the relatively high resin curing stress may change inductance values.

For exterior coating, select resin carefully so that electrical and mechanical performance of the product is not affected.

## Packaging

### Minimum Quantity and 8mm Width Taping Dimension

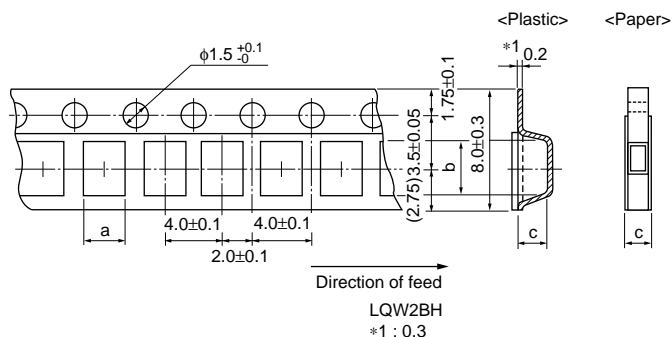

#### Paper Tape

Part Number	Dimensions (in mm)			Minimum QTY. (pcs.)		
	a	b	c	$\phi 180$ mm reel	$\phi 330$ mm reel	Bulk
LQM21NN (0.1-2.2 $\mu$ H)	1.45	2.25	1.1	4000	10000	1000
LQM21DN (1-10 $\mu$ H)						
LQM21FN (1-2.2 $\mu$ H)						
LQG18H	1.05	1.85	1.0			
LQM18N			1.1			
LQW18A	1.00	1.80	0.95			

#### Plastic Tape

Part Number	Dimensions (in mm)			Minimum QTY. (pcs.)		
	a	b	c	$\phi 180$ mm reel	$\phi 330$ mm reel	Bulk
LQM21NN (2.7-4.7 $\mu$ H)	1.45	2.25	1.3	4000	10000	1000
LQM21DN (22-47 $\mu$ H)						
LQM21FN (4.7-47 $\mu$ H)						
LQM31F	1.9	3.5	1.3	3000		
LQH31M/31C/31H, LQW31H	1.9	3.6	2.0	2000	7500	-
LQW2BH	1.75	2.3				
LQH32M/LQH32C	2.9	3.6	2.1			
LQH32CN_51			1.7			

(in mm)

Continued on the following page.

## Packaging

Continued from the preceding page.

### Minimum Quantity and 8mm Width Taping Dimension

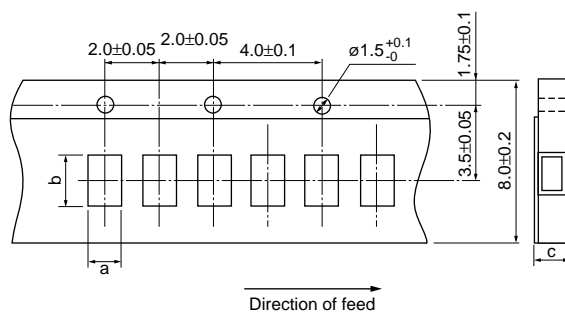

Paper Tape

Part Number	Dimensions (in mm)			Minimum QTY. (pcs.)		
	a	b	c	φ180mm reel	φ330mm reel	Bulk
LQG15H	0.62	1.12	1.0	10000	50000	1000
LQP03T	0.38	0.68				-
LQP15M	0.70	1.20	0.8		-	500
LQW15A						

(in mm)

### Minimum Quantity and 12mm Width Plastic Taping Dimension

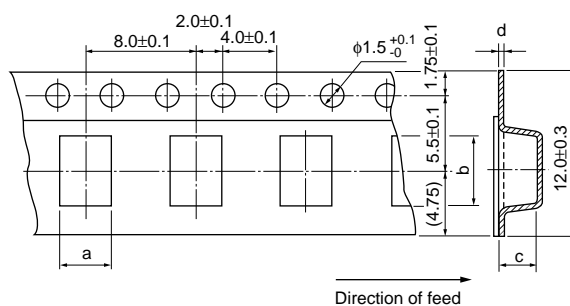

Part Number	Dimensions (in mm)				Minimum QTY. (pcs.)	
	a	b	c	d	φ180mm reel	φ330mm reel
LQH3ER, LQH3KS	3.9	3.7	1.9	0.3	1000	-
LQH43M(N)	3.6	4.9	2.7		500	2500
LQH43C				0.4	350	-
LQH55D	1500					
LQH66S	-					

(in mm)

## Design Kits



### ●EKL12UB (High-frequency Winding Type)

No.	Part Number	Quantity (pcs.)	Inductance (nH)	Inductance Tolerance	Rated Current (mA)
1	LQW2BHN3N3D01	20	3.3	±0.5nH	910
2	LQW2BHN6N8D01	20	6.8	±0.5nH	680
3	LQW2BHN8N2D01	20	8.2	±0.5nH	630
4	LQW2BHN10NJ01	20	10	±5%	1320
5	LQW2BHN12NJ01	20	12	±5%	680
6	LQW2BHN15NJ01	20	15	±5%	630
7	LQW2BHN18NJ01	20	18	±5%	690
8	LQW2BHN22NJ01	20	22	±5%	720
9	LQW2BHN27NJ01	20	27	±5%	540
10	LQW2BHN33NJ01	20	33	±5%	570
11	LQW2BHN39NJ01	20	39	±5%	730
12	LQW2BHN47NJ01	20	47	±5%	450
13	LQW2BHN56NJ01	20	56	±5%	430
14	LQW2BHN68NJ01	20	68	±5%	460
15	LQW2BHN82NJ01	20	82	±5%	320
16	LQW2BHNR10J01	20	100	±5%	350
17	LQW2BHNR12J01	20	120	±5%	320
18	LQW2BHNR15J01	20	150	±5%	390
19	LQW2BHNR18J01	20	180	±5%	250
20	LQW2BHNR22J01	20	220	±5%	240
21	LQW2BHNR27K01	20	270	±10%	190
22	LQW2BHNR33K01	20	330	±10%	180
23	LQW2BHNR39K01	20	390	±10%	170
24	LQW2BHNR47K01	20	470	±10%	160
25	LQW2BHN2N7D11	20	2.7	±0.5nH	1900
26	LQW2BHN3N1D11	20	3.1	±0.5nH	1800
27	LQW2BHN3N3D11	20	3.3	±0.5nH	1700
28	LQW2BHN5N6D11	20	5.6	±0.5nH	1500
29	LQW2BHN6N8D11	20	6.8	±0.5nH	1400
30	LQW2BHN8N6D11	20	8.6	±0.5nH	1300
31	LQW2BHN10NJ11	20	10	±5%	1320
32	LQW2BHN12NK11	20	12	±10%	1100
33	LQW2BHN15NK11	20	15	±10%	1000
34	LQW2BHN18NK11	20	18.8	±10%	1000
35	LQW2BHN21NK11	20	21	±10%	950
36	LQW2BHN27NK11	20	27	±10%	900

## Design Kits

### ●EKLM13UB (High-frequency Monolithic Type)

No.	Part Number	Quantity (pcs.)	Inductance (nH)	Inductance Tolerance	Rated Current (mA)
1	LQG18HN1N2S00	20	1.2	±0.3nH	300
2	LQG18HN1N5S00	20	1.5	±0.3nH	300
3	LQG18HN1N8S00	20	1.8	±0.3nH	300
4	LQG18HN2N2S00	20	2.2	±0.3nH	300
5	LQG18HN2N7S00	20	2.7	±0.3nH	300
6	LQG18HN3N3S00	20	3.3	±0.3nH	300
7	LQG18HN3N9S00	20	3.9	±0.3nH	300
8	LQG18HN4N7S00	20	4.7	±0.3nH	300
9	LQG18HN5N6S00	20	5.6	±0.3nH	300
10	LQG18HN6N8J00	20	6.8	±5%	300
11	LQG18HN8N2J00	20	8.2	±5%	300
12	LQG18HN10NJ00	20	10	±5%	300
13	LQG18HN12NJ00	20	12	±5%	300
14	LQG18HN15NJ00	20	15	±5%	300
15	LQG18HN18NJ00	20	18	±5%	300
16	LQG18HN22NJ00	20	22	±5%	300
17	LQG18HN27NJ00	20	27	±5%	300
18	LQG18HN33NJ00	20	33	±5%	300
19	LQG18HN39NJ00	20	39	±5%	300
20	LQG18HN47NJ00	20	47	±5%	300
21	LQG18HN56NJ00	20	56	±5%	300
22	LQG18HN68NJ00	20	68	±5%	300
23	LQG18HN82NJ00	20	82	±5%	300
24	LQG18HNR10J00	20	100	±5%	300

### ●EKLM14UC (High-frequency Flim Type)

No.	Part Number	Quantity (pcs.)	Inductance (nH)	Inductance Tolerance	Rated Current (mA)
1	LQP15MN1N0B00	20	1.0	±0.1nH	400
2	LQP15MN1N1B00	20	1.1	±0.1nH	390
3	LQP15MN1N2B00	20	1.2	±0.1nH	390
4	LQP15MN1N3B00	20	1.3	±0.1nH	280
5	LQP15MN1N5B00	20	1.5	±0.1nH	280
6	LQP15MN1N6B00	20	1.6	±0.1nH	220
7	LQP15MN1N8B00	20	1.8	±0.1nH	280
8	LQP15MN2N0B00	20	2.0	±0.1nH	220
9	LQP15MN2N2B00	20	2.2	±0.1nH	220
10	LQP15MN2N4B00	20	2.4	±0.1nH	220
11	LQP15MN2N7B00	20	2.7	±0.1nH	220
12	LQP15MN3N0B00	20	3.0	±0.1nH	190
13	LQP15MN3N3B00	20	3.3	±0.1nH	190
14	LQP15MN3N6B00	20	3.6	±0.1nH	170
15	LQP15MN3N9B00	20	3.9	±0.1nH	170
16	LQP15MN4N3B00	20	4.3	±0.1nH	160
17	LQP15MN4N7B00	20	4.7	±0.1nH	160
18	LQP15MN5N1B00	20	5.1	±0.1nH	140
19	LQP15MN5N6B00	20	5.6	±0.1nH	140
20	LQP15MN6N2B00	20	6.2	±0.1nH	130
21	LQP15MN6N8B00	20	6.8	±0.1nH	130
22	LQP15MN7N5B00	20	7.5	±0.1nH	110
23	LQP15MN8N2B00	20	8.2	±0.1nH	110
24	LQP15MN9N1B00	20	9.1	±0.1nH	100

Continued on the following page. 

## Design Kits

 Continued from the preceding page.

No.	Part Number	Quantity (pcs.)	Inductance (nH)	Inductance Tolerance	Rated Current (mA)
25	LQP15MN10NG00	20	10	±2%	100
26	LQP15MN12NG00	20	12	±2%	90
27	LQP15MN15NG00	20	15	±2%	90
28	LQP15MN18NG00	20	18	±2%	80
29	LQP15MN22NG00	20	22	±2%	70
30	LQP15MN27NG00	20	27	±2%	70
31	LQP15MN33NG00	20	33	±2%	60

### ●EKLM15UB (High-frequency Monolithic Type)

No.	Part Number	Quantity (pcs.)	Inductance (nH)	Inductance Tolerance	Rated Current (mA)
1	LQG15HN1N2S00	20	1.2	±0.3nH	200
2	LQG15HN1N5S00	20	1.5	±0.3nH	200
3	LQG15HN1N8S00	20	1.8	±0.3nH	200
4	LQG15HN2N2S00	20	2.2	±0.3nH	200
5	LQG15HN2N7S00	20	2.7	±0.3nH	200
6	LQG15HN3N3S00	20	3.3	±0.3nH	200
7	LQG15HN3N9S00	20	3.9	±0.3nH	200
8	LQG15HN4N7S00	20	4.7	±0.3nH	200
9	LQG15HN5N6S00	20	5.6	±0.3nH	200
10	LQG15HN6N8J00	20	6.8	±5%	200
11	LQG15HN8N2J00	20	8.2	±5%	200
12	LQG15HN10NJ00	20	10	±5%	200
13	LQG15HN12NJ00	20	12	±5%	200
14	LQG15HN15NJ00	20	15	±5%	200
15	LQG15HN18NJ00	20	18	±5%	200
16	LQG15HN22NJ00	20	22	±5%	200
17	LQG15HN27NJ00	20	27	±5%	200
18	LQG15HN33NJ00	20	33	±5%	200

### ●EKLM16UB (High-frequency Winding Type)

No.	Part Number	Quantity (pcs.)	Inductance (nH)	Inductance Tolerance	Rated Current (mA)
1	LQW18AN3N6C00	20	3.6	±0.2nH	850
2	LQW18AN3N9C00	20	3.9	±0.2nH	850
3	LQW18AN4N3C00	20	4.3	±0.2nH	850
4	LQW18AN5N6C00	20	5.6	±0.2nH	750
5	LQW18AN6N2C00	20	6.2	±0.2nH	750
6	LQW18AN6N8C00	20	6.8	±0.2nH	750
7	LQW18AN10NG00	20	10	±2%	650
8	LQW18AN11NG00	20	11	±2%	650
9	LQW18AN12NG00	20	12	±2%	600
10	LQW18AN13NG00	20	13	±2%	600
11	LQW18AN15NG00	20	15	±2%	600
12	LQW18AN16NG00	20	16	±2%	550
13	LQW18AN18NG00	20	18	±2%	550
14	LQW18AN20NG00	20	20	±2%	550
15	LQW18AN22NG00	20	22	±2%	500
16	LQW18AN24NG00	20	24	±2%	500
17	LQW18AN27NG00	20	27	±2%	440
18	LQW18AN30NG00	20	30	±2%	420
19	LQW18AN33NG00	20	33	±2%	420
20	LQW18AN36NG00	20	36	±2%	400

Continued on the following page. 

## Design Kits

Continued from the preceding page.

No.	Part Number	Quantity (pcs.)	Inductance (nH)	Inductance Tolerance	Rated Current (mA)
21	LQW18AN39NG00	20	39	±2%	400
22	LQW18AN43NG00	20	43	±2%	380
23	LQW18AN47NG00	20	47	±2%	380
24	LQW18AN51NG00	20	51	±2%	370
25	LQW18AN56NG00	20	56	±2%	360
26	LQW18AN62NG00	20	62	±2%	280
27	LQW18AN68NG00	20	68	±2%	340
28	LQW18AN72NG00	20	72	±2%	270
29	LQW18AN75NG00	20	75	±2%	270
30	LQW18AN82NG00	20	82	±2%	250
31	LQW18AN91NG00	20	91	±2%	230
32	LQW18ANR10G00	20	100	±2%	220
33	LQW18ANR11G00	20	110	±2%	200
34	LQW18ANR12G00	20	120	±2%	180
35	LQW18ANR13G00	20	130	±2%	170
36	LQW18ANR15G00	20	150	±2%	160
37	LQW18ANR16G00	20	160	±2%	150
38	LQW18ANR18G00	20	180	±2%	140
39	LQW18ANR20G00	20	200	±2%	120
40	LQW18ANR22G00	20	220	±2%	120

### ●EKLM17UB (High-frequency Winding Type)

No.	Part Number	Quantity (pcs.)	Inductance (nH)	Inductance Tolerance	Rated Current (mA)
1	LQW18AN2N2D00	20	2.2	±0.5nH	700
2	LQW18AN3N6D00	20	3.6	±0.5nH	850
3	LQW18AN3N9D00	20	3.9	±0.5nH	850
4	LQW18AN4N3D00	20	4.3	±0.5nH	850
5	LQW18AN4N7D00	20	4.7	±0.5nH	850
6	LQW18AN5N6D00	20	5.6	±0.5nH	750
7	LQW18AN6N2D00	20	6.2	±0.5nH	750
8	LQW18AN6N8D00	20	6.8	±0.5nH	750
9	LQW18AN7N5D00	20	7.5	±0.5nH	750
10	LQW18AN8N2D00	20	8.2	±0.5nH	650
11	LQW18AN8N7D00	20	8.7	±0.5nH	650
12	LQW18AN9N1D00	20	9.1	±0.5nH	650
13	LQW18AN9N5D00	20	9.5	±0.5nH	650
14	LQW18AN10NJ00	20	10	±5%	650
15	LQW18AN11NJ00	20	11	±5%	650
16	LQW18AN12NJ00	20	12	±5%	600
17	LQW18AN13NJ00	20	13	±5%	600
18	LQW18AN15NJ00	20	15	±5%	600
19	LQW18AN16NJ00	20	16	±5%	550
20	LQW18AN18NJ00	20	18	±5%	550
21	LQW18AN20NJ00	20	20	±5%	550
22	LQW18AN22NJ00	20	22	±5%	500
23	LQW18AN24NJ00	20	24	±5%	500
24	LQW18AN27NJ00	20	27	±5%	440
25	LQW18AN30NJ00	20	30	±5%	420
26	LQW18AN33NJ00	20	33	±5%	420
27	LQW18AN36NJ00	20	36	±5%	400
28	LQW18AN39NJ00	20	39	±5%	400
29	LQW18AN43NJ00	20	43	±5%	380
30	LQW18AN47NJ00	20	47	±5%	380

Continued on the following page. 

## Design Kits

Continued from the preceding page.

No.	Part Number	Quantity (pcs.)	Inductance (nH)	Inductance Tolerance	Rated Current (mA)
31	LQW18AN51NJ00	20	51	±5%	370
32	LQW18AN56NJ00	20	56	±5%	360
33	LQW18AN62NJ00	20	62	±5%	280
34	LQW18AN68NJ00	20	68	±5%	340
35	LQW18AN72NJ00	20	72	±5%	270
36	LQW18AN75NJ00	20	75	±5%	270
37	LQW18AN82NJ00	20	82	±5%	250
38	LQW18AN91NJ00	20	91	±5%	230
39	LQW18ANR10J00	20	100	±5%	220
40	LQW18ANR11J00	20	110	±5%	200
41	LQW18ANR12J00	20	120	±5%	180
42	LQW18ANR13J00	20	130	±5%	170
43	LQW18ANR15J00	20	150	±5%	160
44	LQW18ANR16J00	20	160	±5%	150
45	LQW18ANR18J00	20	180	±5%	140
46	LQW18ANR20J00	20	200	±5%	120
47	LQW18ANR22J00	20	220	±5%	120

### ●EKL21UB (for General Use/ for Choke Monolithic Type)

No.	Part Number	Quantity (pcs.)	Inductance (nH)	Inductance Tolerance (%)	Rated Current (mA)
1	LQM21NNR10K10	20	0.1	±10	250
2	LQM21NNR12K10	20	0.12	±10	250
3	LQM21NNR15K10	20	0.15	±10	250
4	LQM21NNR18K10	20	0.18	±10	250
5	LQM21NNR22K10	20	0.22	±10	250
6	LQM21NNR27K10	20	0.27	±10	250
7	LQM21NNR33K10	20	0.33	±10	250
8	LQM21NNR39K10	20	0.39	±10	200
9	LQM21NNR47K10	20	0.47	±10	200
10	LQM21NNR56K10	20	0.56	±10	150
11	LQM21NNR68K10	20	0.68	±10	150
12	LQM21NNR82K10	20	0.82	±10	150
13	LQM21NN1R0K10	20	1.0	±10	50
14	LQM21NN1R2K10	20	1.2	±10	50
15	LQM21NN1R5K10	20	1.5	±10	50
16	LQM21NN1R8K10	20	1.8	±10	50
17	LQM21NN2R2K10	20	2.2	±10	30
18	LQM21NN2R7K10	20	2.7	±10	30
19	LQM21NN3R3K10	20	3.3	±10	30
20	LQM21NN3R9K10	20	3.9	±10	30
21	LQM21NN4R7K10	20	4.7	±10	30
22	LQM21DN1R0N00	20	1.0	±30	60
23	LQM21DN2R2N00	20	2.2	±30	40
24	LQM21DN4R7N00	20	4.7	±30	30
25	LQM21DN100N00	20	10	±30	15
26	LQM21DN220N00	20	22	±30	13
27	LQM21DN470N00	20	47	±30	7
28	LQM21FN1R0N00	20	1.0	±30	220
29	LQM21FN2R2N00	20	2.2	±30	150
30	LQM21FN4R7N00	20	4.7	±30	80
31	LQM21FN100N00	20	10	±30	60
32	LQM21FN220N00	20	22	±30	13
33	LQM21FN470N00	20	47	±30	7

## Information

### 1. Land Area and Q-F Characteristics

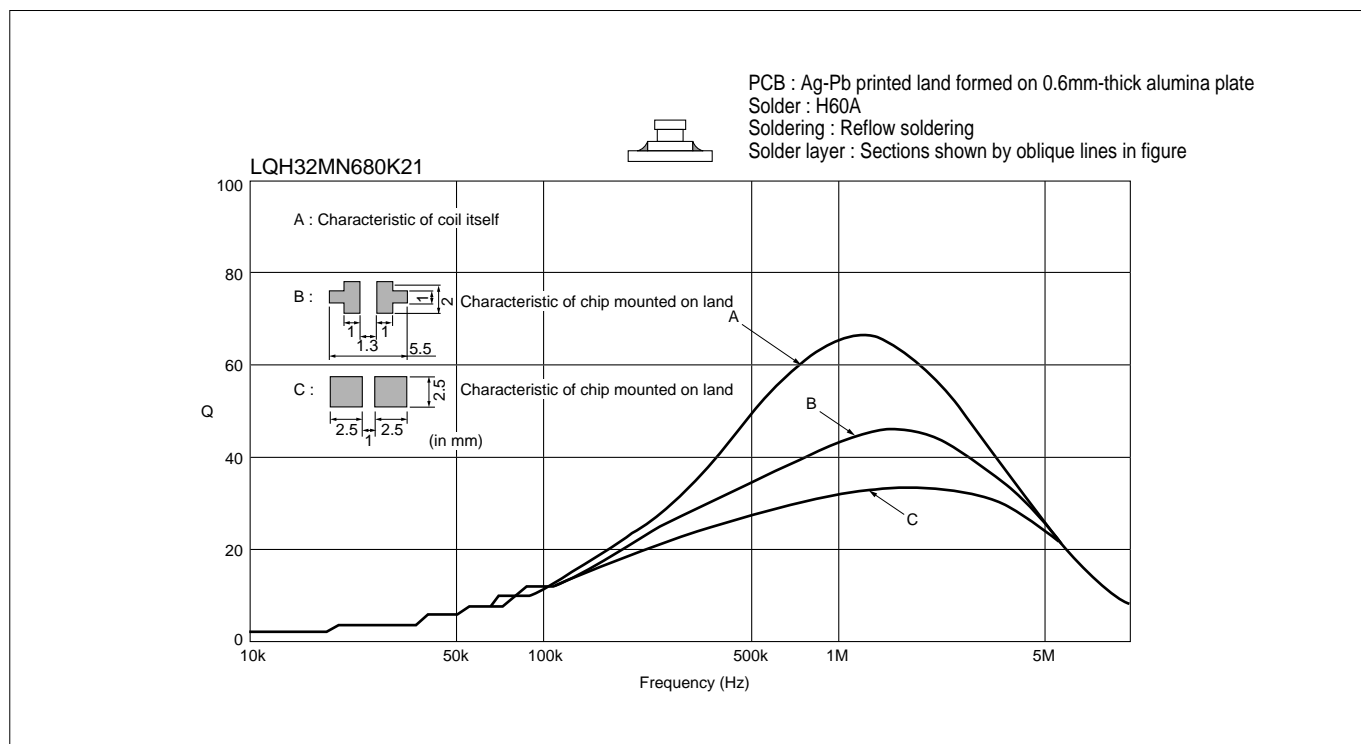

### 2. Coupling coefficient versus Coil-to-coil Spacing

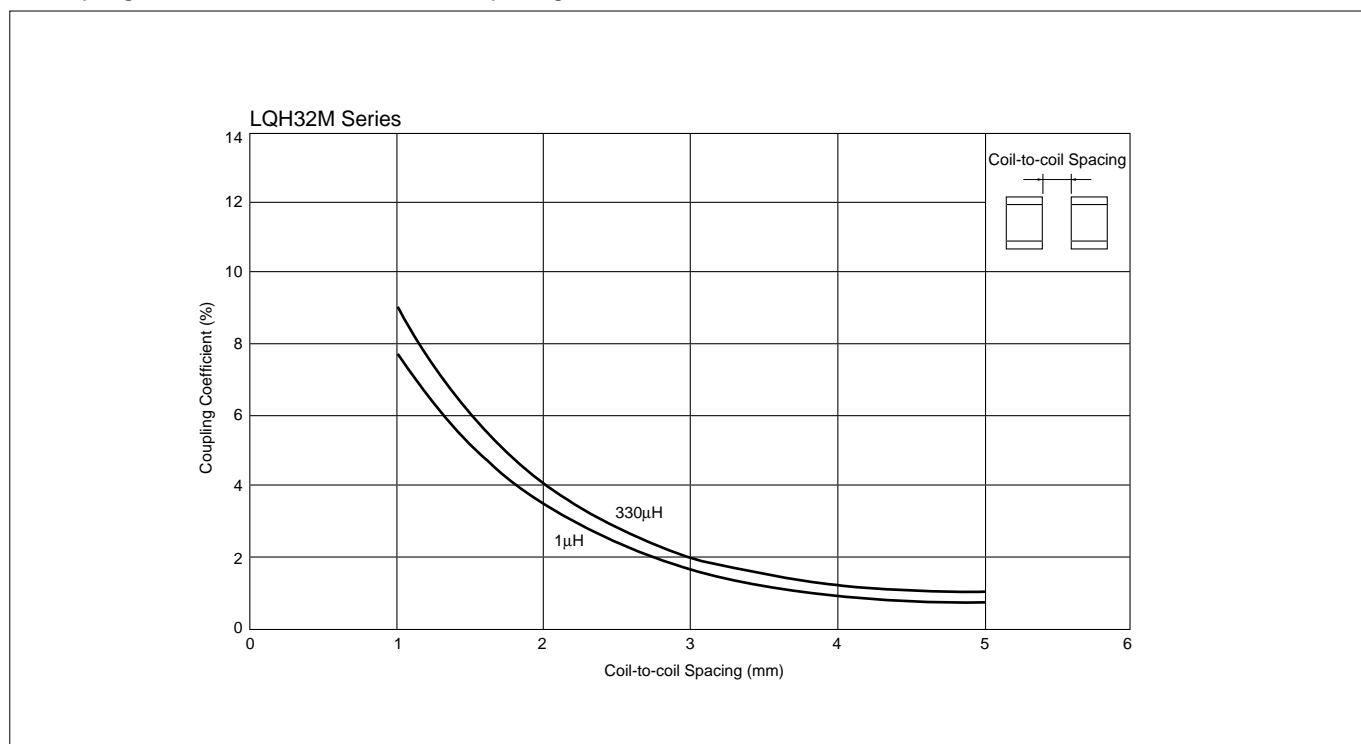

**⚠ Note:**

1. Export Control

⟨For customers outside Japan⟩

Murata products should not be used or sold for use in the development, production, stockpiling or utilization of any conventional weapons or mass-destructive weapons (nuclear weapons, chemical or biological weapons, or missiles), or any other weapons.

⟨For customers in Japan⟩

For products which are controlled items subject to the "Foreign Exchange and Foreign Trade Law" of Japan, the export license specified by the law is required for export.

2. Please contact our sales representatives or product engineers before using our products listed in this catalog for the applications listed below which require especially high reliability for the prevention of defects which might directly cause damage to the third party's life, body or property, or when intending to use one of our products for other applications than specified in this catalog.

- ① Aircraft equipment
- ② Aerospace equipment
- ③ Undersea equipment
- ④ Power plant equipment
- ⑤ Medical equipment
- ⑥ Transportation equipment (vehicles, trains, ships, etc.)
- ⑦ Traffic signal equipment
- ⑧ Disaster prevention / crime prevention equipment
- ⑨ Data-processing equipment
- ⑩ Application of similar complexity and/or reliability requirements to the applications listed in the above

3. Product specifications in this catalog are as of March 2001. They are subject to change or our products in it may be discontinued without advance notice. Please check with our sales representatives or product engineers before your ordering. If there are any questions, please contact our sales representatives or product engineers.

4. Please read CAUTION and Notice in this catalog for safety. This catalog has only typical specifications. Therefore you are requested to approve our product specification or to transact the approval sheet for product specification, before your ordering.

5. Please note that unless otherwise specified, we shall assume no responsibility whatsoever for any conflict or dispute that may occur in connection with the effect of our and/or third party's intellectual property rights and other related rights in consideration of your using our products and/or information described or contained in our catalogs. In this connection, no representation shall be made to the effect that any third parties are authorized to use the rights mentioned above under licenses without our consent.

6. None of ozone depleting substances (ODS) under the Montreal Protocol is used in manufacturing process of us.